



**Specification Status: Released**

**Electrical Rating**  
Voltage: 60V MAX  
Current: 40A MAX

**Insulating Material:**  
Cured, Flame Retardant Epoxy Polymer  
meets UL94 V-0 Requirements

**Lead Material:**  
24 AWG Tin Plated Nickel Copper Alloy

**Marking:**  
 Manufacturer's Mark  
 X10 and Part Identification  
  
 Lot Identification

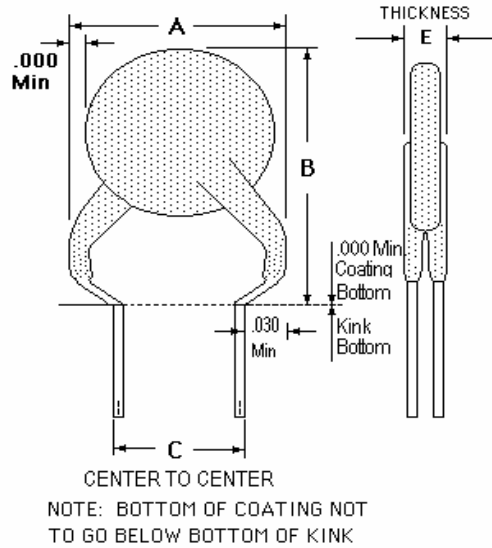

**TABLE I. DIMENSIONS:**

	A		B		C		D		E	
	MIN	MAX	MIN	MAX	MIN	MAX	MIN	MAX	MIN	MAX
mm:	--	8.9	--	11.2	4.3	5.8	7.6	--	--	3.0
in*:	--	(0.35)	--	(0.44)	(0.17)	(0.23)	(0.30)	--	--	(0.12)

\*Rounded off approximation





**TABLE II. PERFORMANCE RATINGS:**

I HOLD RATED CURRENT	CURRENT RATINGS		INITIAL RESISTANCE VALUES		TIME TO TRIP	ONE HOUR POST-TRIP RESISTANCE STANDARD TRIP	TRIPPED- STATE POWER DISSIPATION	
	AMPERES AT 20°C HOLD	AMPERES AT 20°C HOLD   TRIP	OHMS AT 20°C MIN	OHMS AT 20°C MAX			WATTS AT 20°C NOMINAL	WATTS AT 20°C MAX
0.10	0.10	0.20	2.50	4.50	4.0	7.5	0.38	0.53

Agency Recognitions: UL, CSA, TUV, CQC  
 Reference Documents: PS300  
 Precedence: This specification takes precedence over documents referenced herein.  
 Effectivity: Reference documents shall be the issue in effect on the date of invitation for bid.  
 CAUTION: Operation beyond the rated voltage or current may result in rupture, electrical arcing or flame.

**Materials Information**

ROHS Compliant      ELV Compliant      Pb-Free      Halogen Free\*

\* Halogen Free refers to: Br≤900ppm, Cl≤900ppm, Br+Cl≤1500ppm.

Information furnished is believed to be accurate and reliable. However, users should independently evaluate the suitability of and test each product selected for their own applications. Littelfuse products are not designed for, and shall not be used for, any purpose (including, without limitation, military, aerospace, medical, lifesaving, life-sustaining or nuclear facility applications, devices intended for surgical implant into the body, or any other application in which the failure or lack of desired operation of the product may result in personal injury, death, or property damage) other than those expressly set forth in applicable Littelfuse product documentation. Warranties granted by Littelfuse shall be deemed void for products used for any purpose not expressly set forth in applicable Littelfuse documentation. Littelfuse shall not be liable for any claims or damages arising out of products used in applications not expressly intended by Littelfuse as set forth in applicable Littelfuse documentation. The sale and use of Littelfuse products is subject to Littelfuse Terms and Conditions of Sale, unless otherwise agreed by Littelfuse.