







Specification Status: Released

Maximum Electrical Rating at 20°C
30 V_{DC} / 100 A_{DC}
30 V_{AC} / 70 A_{RMS}

Insulating Material:
Cured, Flame Retardant Epoxy Polymer
meets UL94 V-0 Requirements

Lead Material:
20 AWG Tin Plated Copper

Marking:
 Manufacturer's Mark
 U300 and Part Identification

    Lot Identification

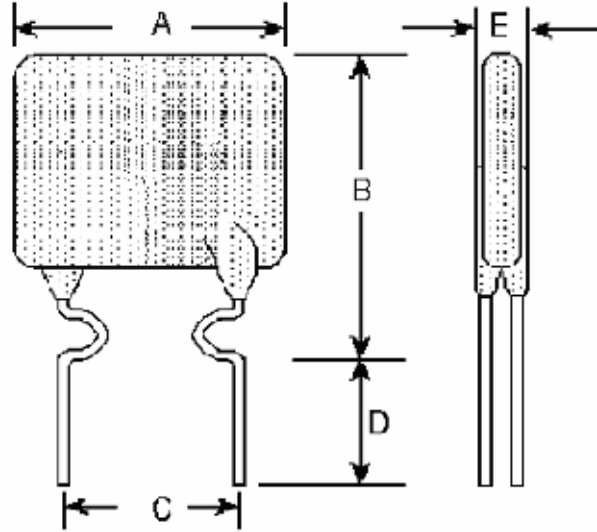

TABLE I. DIMENSIONS:

	A		B		C		D		E	
	MIN	MAX	MIN	MAX	MIN	MAX	MIN	MAX	MIN	MAX
mm:	--	11.4	--	18.03	4.3	5.8	7.6	--	--	3.0
in*:	--	(0.45)	--	(0.71)	(0.17)	(0.23)	(0.30)	--	--	(0.12)

*Rounded off approximation

TABLE II. PERFORMANCE RATINGS:

I HOLD	CURRENT RATINGS		TIME TO TRIP	RESISTANCE		ONE-HOUR POST-TRIP RESISTANCE STANDARD TRIP	TRIPPED POWER DISSIPATION	
	AMPS 20°C HOLD	AMPS AT 20°C HOLD TRIP	SECONDS AT 20°C, 15.0A MAX	OHMS AT 20.0° C MIN	OHMS AT 20.0° C MAX	OHMS AT 20°C MAX	WATTS AT 20°C NOMINAL	WATTS AT 20°C MAX
3.00	3.00	6.00	10.8	0.02	0.05	0.08	2.00	2.51

Agency Recognitions: UL, CSA, TUV, CQC
 Reference Documents: PS300
 Precedence: This specification takes precedence over documents referenced herein.
 Effectivity: Reference documents shall be the issue in effect on the date of invitation for bid.
 CAUTION: Operation beyond the rated voltage or current may result in rupture, electrical arcing or flame

Materials Information

ROHS Compliant

ELV Compliant

Pb-Free

Halogen Free*

Directive 2002/95/EC
Compliant

Directive 2000/53/EC
Compliant



* Halogen Free refers to: Br≤900ppm, Cl≤900ppm, Br+Cl≤1500ppm.

PolySwitch®
PTC Devices
Overcurrent Protection Device

PRODUCT: RUEF300K

DOCUMENT: SCD25894
REV LETTER: F
REV DATE: JULY 26, 2016
PAGE NO.: 2 OF 2

Information furnished is believed to be accurate and reliable. However, users should independently evaluate the suitability of and test each product selected for their own applications. Littelfuse products are not designed for, and shall not be used for, any purpose (including, without limitation, military, aerospace, medical, lifesaving, life-sustaining or nuclear facility applications, devices intended for surgical implant into the body, or any other application in which the failure or lack of desired operation of the product may result in personal injury, death, or property damage) other than those expressly set forth in applicable Littelfuse product documentation. Warranties granted by Littelfuse shall be deemed void for products used for any purpose not expressly set forth in applicable Littelfuse documentation. Littelfuse shall not be liable for any claims or damages arising out of products used in applications not expressly intended by Littelfuse as set forth in applicable Littelfuse documentation. The sale and use of Littelfuse products is subject to Littelfuse Terms and Conditions of Sale, unless otherwise agreed by Littelfuse.