

Specification Status: Released

Electrical Rating

Voltage: 16V MAX
Current: 100A MAX

Insulating Material:
Cured, Flame Retardant Epoxy Polymer
meets UL94 V-0 Requirements

Lead Material:
18 AWG Tin Plated Copper
(1.0mm [0.040] nom. diameter)

Marking:
— Manufacturer's Mark
⊗ G14 and Part Identification

□□□□ — Lot Identification

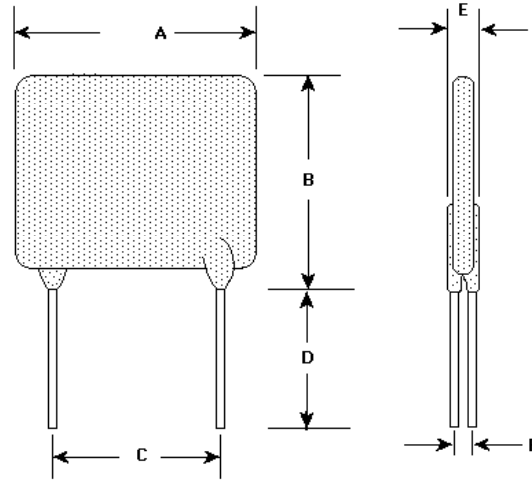

TABLE I. DIMENSIONS:

	A		B		C		D		E		F
	MIN	MAX	MIN	MAX	MIN	MAX	MIN	MAX	MIN	MAX	TYP
mm	--	23.5	22.6	27.9	9.4	10.9	7.6	--	2.3	3.5	1.4
in*	--	(0.925)	(0.89)	(1.10)	(0.37)	(0.43)	(0.30)	--	(0.09)	(0.14)	(0.06)

*Rounded off approximation

TABLE II. PERFORMANCE RATINGS:

I HOLD RATED CURRENT	CURRENT RATINGS		INITIAL RESISTANCE VALUES		TIME TO TRIP	R ₁ MAX 1 HR. POST TRIP RESISTANCE STANDARD TRIP	TRIPPED- STATE POWER DISSIPATION
	AMPS AT 25°C HOLD	AMPS AT 25°C HOLD TRIP	OHMS AT 25°C MIN MAX		SECONDS AT 25°C, 70A MAX	OHMS AT 25°C MAX	WATTS AT 25°C TYP
14.0	14.0	23.8	0.0026	0.0043	9.0	0.0064	4.6

Agency Recognitions: UL, CSA, TUV.
Reference Documents: PS300
Precedence: This specification takes precedence over documents referenced herein.
Effectivity: Reference documents shall be the issue in effect on the date of invitation for bid.
CAUTION: Operation beyond the rated voltage or current may result in rupture, electrical arcing or flame.

Materials Information

ROHS Compliant

ELV Compliant

Pb-Free

Halogen Free*

Directive 2002/95/EC
Compliant

Directive 2000/53/EC
Compliant



* Halogen Free refers to: Br≤900ppm, Cl≤900ppm, Br+Cl≤1500ppm.

Information furnished is believed to be accurate and reliable. However, users should independently evaluate the suitability of and test each product selected for their own applications. Littelfuse products are not designed for, and shall not be used for, any purpose (including, without limitation, military, aerospace, medical, lifesaving, life-sustaining or nuclear facility applications, devices intended for surgical implant into the body, or any other application in which the failure or lack of desired operation of the product may result in personal injury, death, or property damage) other than those expressly set forth in applicable Littelfuse product documentation. Warranties granted by Littelfuse shall be deemed void for products used for any purpose not expressly set forth in applicable Littelfuse documentation. Littelfuse shall not be liable for any claims or damages arising out of products used in applications not expressly intended by Littelfuse as set forth in applicable Littelfuse documentation. The sale and use of Littelfuse products is subject to Littelfuse Terms and Conditions of Sale, unless otherwise agreed by Littelfuse.