

# 600R Series

## Radial Leaded

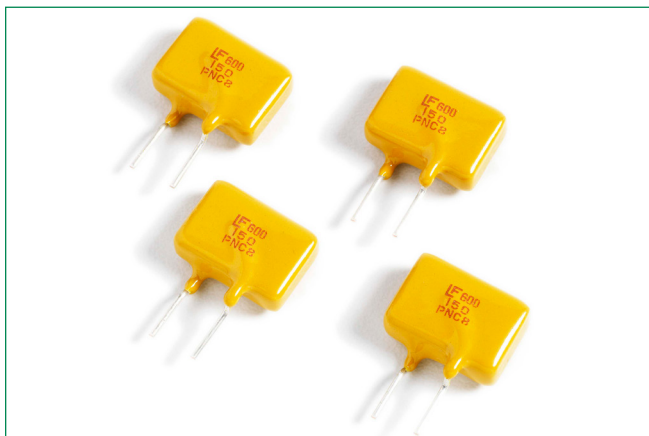

### Description

The 600R Series is designed to protect against power fault events typically found in telecom applications. This series is designed to be used in applications that need to meet the requirements of GR-1089-CORE and UL60950/EN60950/IEC60950. These resettable devices also help to meet the requirements of ITU K.20, K.21 and K.44.

### Features & Benefits

- 0.15 – 0.16A hold current range, 60VDC operating voltage
- 600VAC interrupt rating
- Fast time-to-trip
- Binned and sorted narrow resistance ranges available
- RoHS compliant, Lead-Free and Halogen-Free\*

### Additional Information



Resources



Accessories



Samples

### Agency Approvals

Agency	Agency File Number
	E74889
	R72161780

### Applications

Secondary overcurrent protection for:

- Central Office Equipment (CO)
- Customer Premises Equipment (CE)
- Alarm systems
- Set Top Boxes (STB)
- Voice over IP (VOIP)
- Subscriber Line Interface Circuit (SLIC)

### Electrical Characteristics

Part Number	I <sub>hold</sub> (A)	I <sub>trip</sub> (A)	V <sub>max</sub> / V <sub>int</sub> / V <sub>op</sub>	I <sub>max</sub> (A)	P <sub>d</sub> typ. (W)	Maximum Time To Trip			Resistance			Agency Approvals	
						Current (A)	Time (Sec.)	R <sub>min</sub> (Ω)	R <sub>typ</sub> (Ω)	R <sub>1max</sub> (Ω)			
600R150	0.15	0.30	600/60	3	1.00	1	4	6	10	17	X	X	
600R150-RA	0.15	0.30	600/60	3	1.00	1	4	7	10	20	X	X	
600R150-RB	0.15	0.30	600/60	3	1.00	1	3	9	12	22	X	X	
600R160	0.16	0.32	600/60	3	1.00	1	10	4	10	18	X	X	

**Caution:** Operation beyond the specified rating may result in damage and possible arcing and flame.

I<sub>hold</sub> = Hold current: maximum current device will pass without tripping in 20°C still air.  
 I<sub>trip</sub> = Trip current: minimum current at which the device will trip in 20°C still air.  
 V<sub>max</sub> = Maximum voltage the device can withstand without damage at rated current (I<sub>max</sub>)  
 V<sub>op</sub> = The device regular operation voltage  
 I<sub>max</sub> = Maximum fault current device can withstand without damage at rated voltage (V<sub>max</sub>)  
 P<sub>d</sub> = Power dissipated from device when in the tripped state at 20°C still air.

R<sub>min</sub> = Minimum resistance of device in initial (un-soldered) state.  
 R<sub>typ</sub> = Typical resistance of device in initial (un-soldered) state.  
 R<sub>1max</sub> = Maximum resistance of device at 20°C measured one hour after tripping.

\* Effective February 11, 2010 onward, all 600R PTC products will be manufactured Halogen Free (HF). Existing Non-Halogen Free 600R PTC products may continue to be sold, until supplies are depleted. This change will have no effect on 600R product specifications or performance.

### Warning

- Users shall independently assess the suitability of these devices for each of their applications
- Operation of these devices beyond the stated maximum ratings could result in damage to the devices and lead to electrical arcing and/or fire
- These devices are intended to protect against the effects of temporary over-current or over-temperature conditions and are not intended to perform as protective devices where such conditions are expected to be repetitive or prolonged in duration
- Exposure to silicon-based oils, solvents, electrolytes, acids, and similar materials can adversely affect the performance of these PPTC devices
- These devices undergo thermal expansion under fault conditions, and thus shall be provided with adequate space and be protected against mechanical stresses
- Circuits with inductance may generate a voltage (L di/dt) above the rated voltage of the PPTC device.

# 600R Series

## Radial Leaded

### Temperature Derating

Ambient Operation Temperature							
	-40°C	-20°C	0°C	23°C	40°C	60°C	85°C
Part Number	Hold Current (A)						
600R150	0.240	0.211	0.183	0.150	0.124	0.093	0.054
600R160	0.256	0.226	0.195	0.160	0.132	0.099	0.058

### Average Time Current Curves

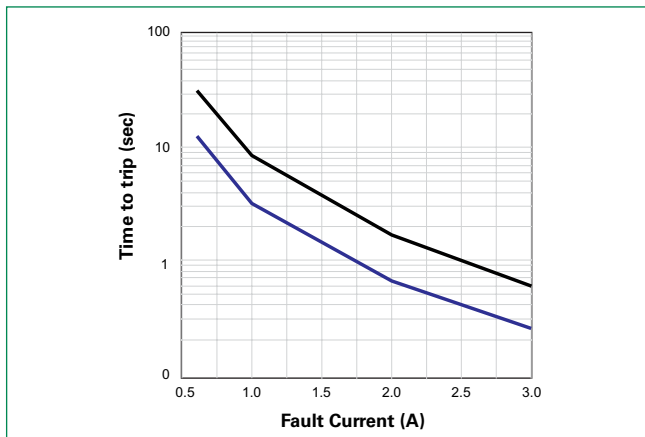

The average time current curves and Temperature Derating curve performance is affected by a number of variables, and these curves provided as guidance only. Customer must verify the performance in their application.

### Temperature Derating Curve

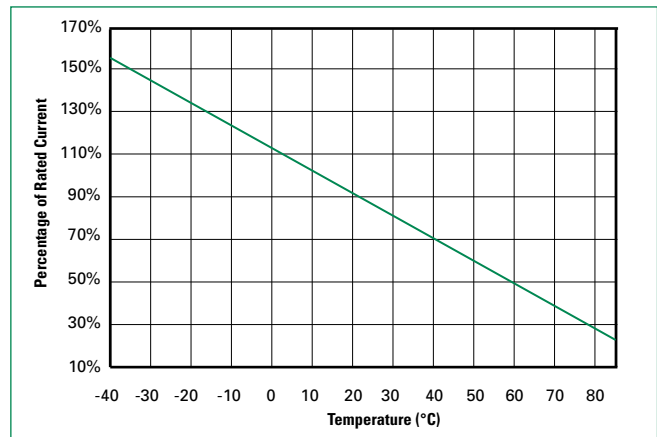

Note: Typical Temperature derating curve, refer to table for derating data

### Agency Specification Selection Guide For Telecom and Networking Applications

Part Number	Lightning	Power Cross
600R150	TIA-968-A – 1.5kV 10/160µs 800V 10/560µs	UL60950, 3rd Ed – 600Vac
600R160	Telcordia GR 1089 – 1.0kV 10/1000µs 2.5kV 2/10µs	Telcordia GR – 1089 – 600Vac, 60A

Note: Devices should be independently evaluated and tested for use in any specific application

### Protection Application Guide

Region/Specification	Application	Device Selection
North America Telcordia GR-1089	*Access network equipment Remote terminal. Repeaters WAN equipment Cross - connect	600R150 600R160
North America TIA-968-A, UL60950	Customer and IT equipment Analog modems, ADSL, XDSL modems, Phone sets, PBX systems, Internet appliances, POS terminals	600R150 600R160
North America Telcordia GR-1089	Central Office, POTS/ISDN linecards, T1/E1/J1 linecards, ADSL/VDSL splitters, CSU/DSU	600R150 600R160
North America Telcordia GR-1089 South America/Asia/Europe ITU K.20 and K.21	*Intrabuilding communication systems, LAN, VOIP cards, Local loop handsets,	600R150 600R160

\*Resistance binned parts are recommended

# 600R Series

## Radial Leaded

### Soldering Parameters - Wave Soldering

<b>Condition</b>	Wave Soldering
<b>Peak Temp/ Duration Time</b>	260°C ≤ 5 Sec
<b>≥ 220°C</b>	2 Sec ~ 20 Sec
<b>Preheat 140°C~ 180°C</b>	180 Sec ~ 210 Sec
<b>Storage Condition</b>	0°C~35°C, ≤ 70%RH

- Note:**
- Recommended soldering methods: heat element oven or N2 environment for lead-free
  - Devices are designed to be wave soldered to the bottom side of the board.
  - Devices can be cleaned using standard industry methods and solvents.
  - This profile can be used for lead-free device
  - If soldering temperatures exceed the recommended profile, devices may not meet the performance requirements.

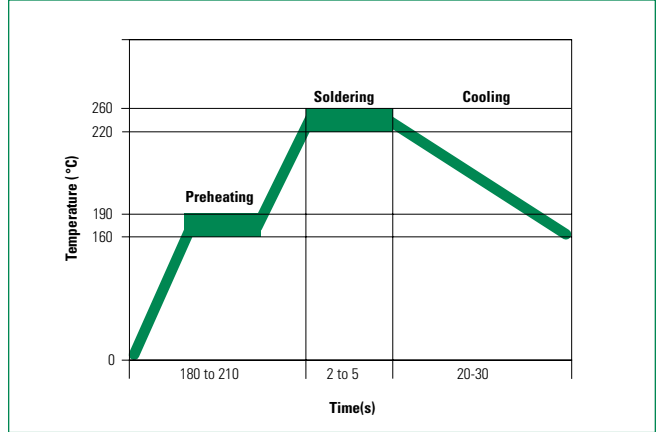

### Physical Specifications

<b>Lead Material</b>	Tin-plated Copper
<b>Soldering Characteristics</b>	Solderability per MIL-STD-202, Method 208
<b>Insulating Material</b>	Cured, flame retardant epoxy polymer meets UL94V-0 requirements.
<b>Device Labeling</b>	Marked with 'LF', voltage, current rating, and date code.

### Environmental Specifications

<b>Operating/Storage Temperature</b>	-40°C to +85°C
<b>Maximum Device Surface Temperature in Tripped State</b>	125°C
<b>Passive Aging</b>	85°C/85°C, 1000 hours
<b>Humidity Aging</b>	+85°C, 85% R.H., 1000 hours
<b>Thermal Shock</b>	MIL-STD-202, Method 107 +125°C to -55°C 10 times
<b>Solvent Resistance</b>	MIL-STD-202, Method 215

### Part Ordering Number System

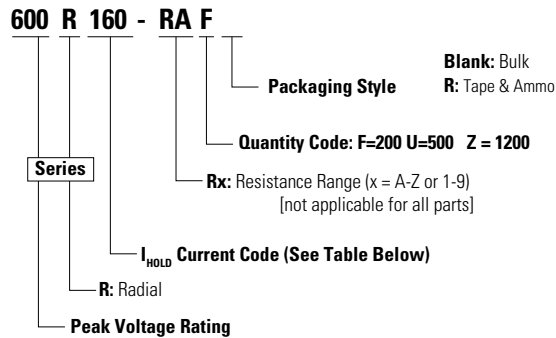

### Part Marking System

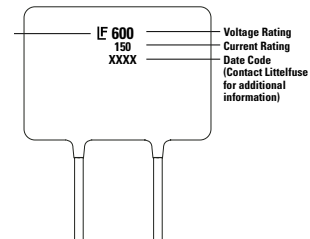

### Dimensions

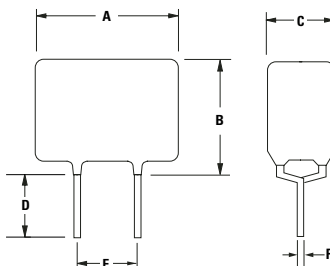

Part Number	A		B		C		D		E		Physical Characteristics		
	Inches	mm	Inches	mm	Inches	mm	Inches	mm	Inches	mm	Lead (dia)		Material
	Max.	Max.	Max.	Max.	Max.	Max.	Min.	Min.	Typ.	Typ.	Inches	mm	
600R150	0.35	9	0.49	12.5	0.18	4.6	0.19	4.7	0.20	5.1	0.026	0.65	Sn/Cu
600R150-RA	0.35	9	0.49	12.5	0.18	4.6	0.19	4.7	0.20	5.1	0.026	0.65	Sn/Cu
600R150-RB	0.35	9	0.49	12.5	0.18	4.6	0.19	4.7	0.20	5.1	0.026	0.65	Sn/Cu
600R160	0.63	16	0.50	12.6	0.24	6	0.19	4.7	0.20	5.1	0.026	0.65	Sn/Cu

# 600R Series

## Radial Leaded

### Packaging

Part Number	Ordering Number	$I_{hold}^{(A)}$	$I_{hold}$ Code	Packaging Option	Quantity	Quantity & Packaging Codes
600R150	600R150F	0.15	150	Bulk	200	F
	600R150ZR			Tape and Ammo	1200	ZR
600R150-RA	600R150-RAF	0.15	150	Bulk	200	F
600R150-RB	600R150-RBZR	0.15	150	Tape and Ammo	1200	ZR
600R160	600R160UR	0.16	160	Tape and Ammo	500	UR

### Tape and Ammo Specifications

Devices taped using EIA468-B/IE286-2 standards. See table below and Figure 1 for details.

Dimension	EIA Mark	IEC Mark	Dimensions	
			Dim. (mm)	Tol. (mm)
Carrier tape width	W	W	18	-0.5 / +1.0
Hold down tape width:	W <sub>4</sub>	W <sub>0</sub>	11	min.
Top distance between tape edges	W <sub>6</sub>	W <sub>2</sub>	3	max.
Sprocket hole position	W <sub>5</sub>	W <sub>1</sub>	9	-0.5 / +0.75
Sprocket hole diameter*	D <sub>0</sub>	D <sub>0</sub>	4	-0.32 / +0.2
Abscissa to plane(straight lead)	H	H	18.5	-/+ 3.0
Abscissa to plane(kinked lead)	H <sub>0</sub>	H <sub>0</sub>	16	-/+ 0.5
Abscissa to top	H <sub>1</sub>	H <sub>1</sub>	32.2	max.
Overall width w/o lead protrusion	C <sub>1</sub>	-	42.5	max.
Overall width w/ lead protrusion	C <sub>2</sub>	-	43.2	max.
Lead protrusion	L <sub>1</sub>	I <sub>1</sub>	1.0	max.
Protrusion of cut out	L	L	11	max.
Protrusion beyond hold-down tape	I <sub>2</sub>	I <sub>2</sub>	Not specified	-
Sprocket hole pitch: 600R150 & 600R160	P <sub>0</sub>	P <sub>0</sub>	25.4	-/+ 0.5
Device pitch: 600R150 & 600R160	-	-	25.4	-
Pitch tolerance	-	-	20 consecutive.	-/+ 1
Tape thickness	t	t	0.9	max.
Tape thickness with splice	t <sub>1</sub>	-	2.0	max.
Splice sprocket hole alignment	-	-	0	-/+ 0.3
Body lateral deviation	Δh	Δh	0	-/+ 1.0
Body tape plane deviation	Δp	Δp	0	-/+ 1.3
Ordinate to adjacent component lead*	P <sub>1</sub>	P <sub>1</sub>	3.81	-/+ 0.7
Lead spacing	F	F	5.08	-/+ 0.8

\*Differs from EIA Specification

### Tape and Ammo Diagram

Figure 1

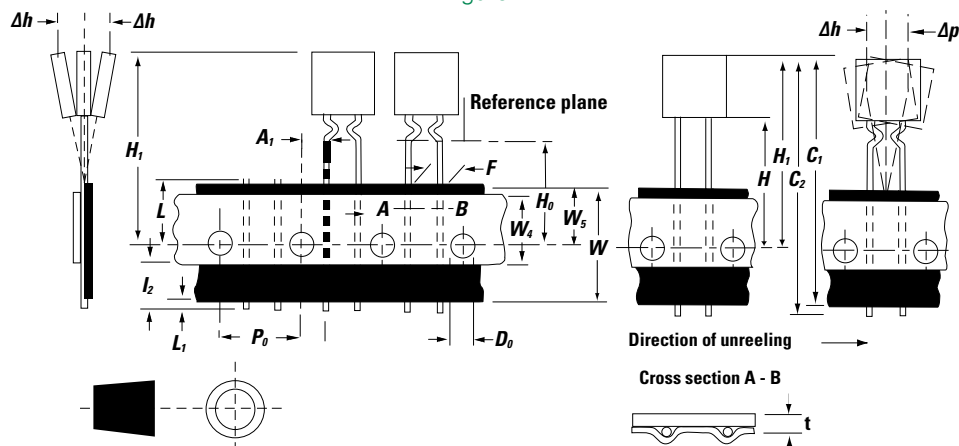

**Disclaimer Notice** - Information furnished is believed to be accurate and reliable. However, users should independently evaluate the suitability of and test each product selected for their own applications. Littelfuse products are not designed for, and may not be used in, all applications. Read complete Disclaimer Notice at [www.littelfuse.com/disclaimer-electronics](http://www.littelfuse.com/disclaimer-electronics).