

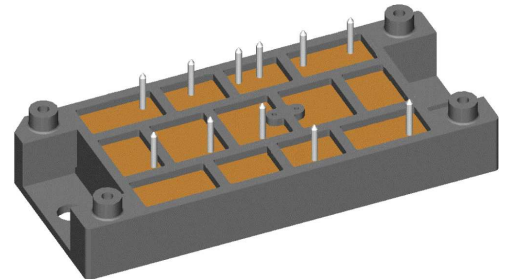
# Thyristor Module

3~ Rectifier	Brake Chopper
$V_{RRM} = 1600 \text{ V}$	$V_{CES} = 1200 \text{ V}$
$I_{DAV} = 180 \text{ A}$	$I_{C25} = 180 \text{ A}$
$I_{FSM} = 700 \text{ A}$	$V_{CE(sat)} = 1.7 \text{ V}$

3~ Rectifier Bridge, half-controlled (high-side) + Brake Unit

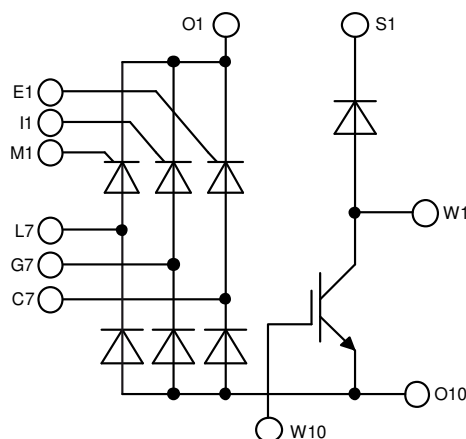
Part number

**VVZB120-16ioX**



Backside: isolated

 E72873



## Features / Advantages:

- Package with DCB ceramic base plate
- Improved temperature and power cycling
- Planar passivated chips
- Very low forward voltage drop
- Very low leakage current
- X2PT - 2nd generation Xtreme light Punch Through
- Rugged X2PT design results in:
  - short circuit rated for 10  $\mu\text{sec}$ .
  - very low gate charge
  - low EMI
  - square RBSOA @ 2x  $I_c$
- Thin wafer technology combined with X2PT design results in a competitive low  $V_{CE(sat)}$  and low thermal resistance

## Applications:

- 3~ Rectifier with brake unit for drive inverters

## Package: V2-Pack

- Isolation Voltage: 3600 V~
- Industry standard outline
- RoHS compliant
- Soldering pins for PCB mounting
- Height: 17 mm
- Base plate: DCB ceramic
- Reduced weight
- Advanced power cycling

## Disclaimer Notice

Information furnished is believed to be accurate and reliable. However, users should independently evaluate the suitability of and test each product selected for their own applications. Littelfuse products are not designed for, and may not be used in, all applications. Read complete Disclaimer Notice at [www.littelfuse.com/disclaimer-electronics](http://www.littelfuse.com/disclaimer-electronics).

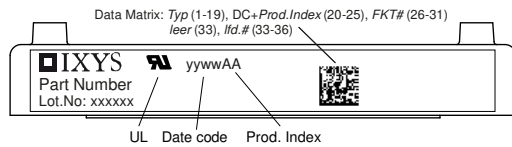
Rectifier			Ratings			
Symbol	Definition	Conditions	min.	typ.	max.	Unit
$V_{RSM/DSM}$	max. non-repetitive reverse/forward blocking voltage	$T_{VJ} = 25^{\circ}C$			1700	V
$V_{RRM/DRM}$	max. repetitive reverse/forward blocking voltage	$T_{VJ} = 25^{\circ}C$			1600	V
$I_{RD}$	reverse current, drain current	$V_{R/D} = 1600\text{ V}$	$T_{VJ} = 25^{\circ}C$		50	$\mu A$
		$V_{R/D} = 1600\text{ V}$	$T_{VJ} = 150^{\circ}C$		20	mA
$V_T$	forward voltage drop	$I_T = 60\text{ A}$	$T_{VJ} = 25^{\circ}C$		1.27	V
		$I_T = 180\text{ A}$			1.90	V
		$I_T = 60\text{ A}$	$T_{VJ} = 125^{\circ}C$		1.25	V
		$I_T = 180\text{ A}$			2.04	V
$I_{DAV}$	bridge output current	$T_C = 85^{\circ}C$	$T_{VJ} = 150^{\circ}C$		180	A
		rectangular $d = 1/3$				
$V_{T0}$	threshold voltage	} for power loss calculation only	$T_{VJ} = 150^{\circ}C$		0.83	V
$r_T$	slope resistance				6.9	m $\Omega$
$R_{thJC}$	thermal resistance junction to case				0.5	K/W
$R_{thCH}$	thermal resistance case to heatsink			0.1		K/W
$P_{tot}$	total power dissipation		$T_C = 25^{\circ}C$		250	W
$I_{TSM}$	max. forward surge current	$t = 10\text{ ms}; (50\text{ Hz}), \text{ sine}$	$T_{VJ} = 45^{\circ}C$		700	A
		$t = 8,3\text{ ms}; (60\text{ Hz}), \text{ sine}$	$V_R = 0\text{ V}$		755	A
		$t = 10\text{ ms}; (50\text{ Hz}), \text{ sine}$	$T_{VJ} = 150^{\circ}C$		595	A
		$t = 8,3\text{ ms}; (60\text{ Hz}), \text{ sine}$	$V_R = 0\text{ V}$		645	A
$I^2t$	value for fusing	$t = 10\text{ ms}; (50\text{ Hz}), \text{ sine}$	$T_{VJ} = 45^{\circ}C$		2.45	kA <sup>2</sup> s
		$t = 8,3\text{ ms}; (60\text{ Hz}), \text{ sine}$	$V_R = 0\text{ V}$		2.37	kA <sup>2</sup> s
		$t = 10\text{ ms}; (50\text{ Hz}), \text{ sine}$	$T_{VJ} = 150^{\circ}C$		1.77	kA <sup>2</sup> s
		$t = 8,3\text{ ms}; (60\text{ Hz}), \text{ sine}$	$V_R = 0\text{ V}$		1.73	kA <sup>2</sup> s
$C_J$	junction capacitance	$V_R = 400\text{ V}$ $f = 1\text{ MHz}$	$T_{VJ} = 25^{\circ}C$		54	pF
$P_{GM}$	max. gate power dissipation	$t_p = 30\text{ }\mu s$	$T_C = 150^{\circ}C$		10	W
		$t_p = 300\text{ }\mu s$			5	W
$P_{GAV}$	average gate power dissipation				0.5	W
$(di/dt)_{cr}$	critical rate of rise of current	$T_{VJ} = 150^{\circ}C; f = 50\text{ Hz}$ repetitive, $I_T = 180\text{ A}$			150	A/ $\mu s$
		$t_p = 200\text{ }\mu s; di_G/dt = 0.45\text{ A}/\mu s;$ $I_G = 0.45\text{ A}; V = 2/3 V_{DRM}$ non-repet., $I_T = 60\text{ A}$			500	A/ $\mu s$
$(dv/dt)_{cr}$	critical rate of rise of voltage	$V = 2/3 V_{DRM}$ $R_{GK} = \infty; \text{ method 1 (linear voltage rise)}$	$T_{VJ} = 150^{\circ}C$		1000	V/ $\mu s$
$V_{GT}$	gate trigger voltage	$V_D = 6\text{ V}$	$T_{VJ} = 25^{\circ}C$		1.5	V
			$T_{VJ} = -40^{\circ}C$		1.6	V
$I_{GT}$	gate trigger current	$V_D = 6\text{ V}$	$T_{VJ} = 25^{\circ}C$		95	mA
			$T_{VJ} = -40^{\circ}C$		200	mA
$V_{GD}$	gate non-trigger voltage	$V_D = 2/3 V_{DRM}$	$T_{VJ} = 150^{\circ}C$		0.2	V
$I_{GD}$	gate non-trigger current				10	mA
$I_L$	latching current	$t_p = 10\text{ }\mu s$	$T_{VJ} = 25^{\circ}C$		450	mA
		$I_G = 0.45\text{ A}; di_G/dt = 0.45\text{ A}/\mu s$				
$I_H$	holding current	$V_D = 6\text{ V}$ $R_{GK} = \infty$	$T_{VJ} = 25^{\circ}C$		200	mA
$t_{gd}$	gate controlled delay time	$V_D = 1/2 V_{DRM}$	$T_{VJ} = 25^{\circ}C$		2	$\mu s$
		$I_G = 0.45\text{ A}; di_G/dt = 0.45\text{ A}/\mu s$				
$t_q$	turn-off time	$V_R = 100\text{ V}; I_T = 60\text{ A}; V = 2/3 V_{DRM}$ $di/dt = 10\text{ A}/\mu s$ $dv/dt = 20\text{ V}/\mu s$ $t_p = 200\text{ }\mu s$	$T_{VJ} = 125^{\circ}C$		150	$\mu s$



Brake IGBT + Diode				Ratings			
Symbol	Definition	Conditions	min.	typ.	max.	Unit	
$V_{CES}$	collector emitter voltage	$T_{VJ} = 25^{\circ}C$			1200	V	
$V_{GES}$	max. DC gate voltage				$\pm 20$	V	
$V_{GEM}$	max. transient gate emitter voltage				$\pm 30$	V	
$I_{C25}$	collector current	$T_C = 25^{\circ}C$			180	A	
$I_{C80}$		$T_C = 80^{\circ}C$			140	A	
$P_{tot}$	total power dissipation	$T_C = 25^{\circ}C$			500	W	
$V_{CE(sat)}$	collector emitter saturation voltage	$I_C = 100\text{ A}; V_{GE} = 15\text{ V}$			1.7	V	
					1.9	V	
$V_{GE(th)}$	gate emitter threshold voltage	$I_C = 4\text{ mA}; V_{GE} = V_{CE}$	6	6.8	7.5	V	
$I_{CES}$	collector emitter leakage current	$V_{CE} = V_{CES}; V_{GE} = 0\text{ V}$			0.1	mA	
					0.1	mA	
$I_{GES}$	gate emitter leakage current	$V_{GE} = \pm 20\text{ V}$			500	nA	
$Q_{G(on)}$	total gate charge	$V_{CE} = 600\text{ V}; V_{GE} = 15\text{ V}; I_C = 100\text{ A}$		340		nC	
$t_{d(on)}$	turn-on delay time	inductive load $V_{CE} = 600\text{ V}; I_C = 100\text{ A}$ $V_{GE} = \pm 15\text{ V}; R_G = 6.8\ \Omega$	$T_{VJ} = 125^{\circ}C$		230	ns	
$t_r$	current rise time				70	ns	
$t_{d(off)}$	turn-off delay time				380	ns	
$t_f$	current fall time				230	ns	
$E_{on}$	turn-on energy per pulse				12.5	mJ	
$E_{off}$	turn-off energy per pulse				11.5	mJ	
<b>RBSOA</b>	reverse bias safe operating area	$V_{GE} = \pm 15\text{ V}; R_G = 6.8\ \Omega$					
$I_{CM}$		$V_{CEK} = 1200\text{ V}$			300	A	
<b>SCSOA</b>	short circuit safe operating area	$V_{CEK} = 1200\text{ V}$					
$t_{SC}$	short circuit duration	$V_{CE} = 720\text{ V}; V_{GE} = \pm 15$			10	$\mu s$	
$I_{SC}$	short circuit current	$R_G = 6.8\ \Omega$ ; non-repetitive		450		A	
$R_{thJC}$	thermal resistance junction to case				0.25	K/W	
$R_{thCH}$	thermal resistance case to heatsink			0.10		K/W	
<b>Brake Diode</b>							
$V_{RRM}$	max. repetitive reverse voltage	$T_{VJ} = 25^{\circ}C$			1200	V	
$I_{F25}$	forward current	$T_C = 25^{\circ}C$			48	A	
$I_{F80}$		$T_C = 80^{\circ}C$			32	A	
$V_F$	forward voltage	$I_F = 30\text{ A}$			2.75	V	
					1.60	V	
$I_R$	reverse current	$V_R = V_{RRM}$			0.25	mA	
					1	mA	
$Q_{rr}$	reverse recovery charge	$V_R = 600\text{ V}$ $-di_f/dt = 1000\text{ A}/\mu s$ $I_F = 30\text{ A}; V_{GE} = 0\text{ V}$	$T_{VJ} = 125^{\circ}C$		5.2	$\mu C$	
$I_{RM}$	max. reverse recovery current				50	A	
$t_{rr}$	reverse recovery time				300	ns	
$E_{rec}$	reverse recovery energy				1.9	mJ	
$R_{thJC}$	thermal resistance junction to case				0.9	K/W	
$R_{thCH}$	thermal resistance case to heatsink			0.3		K/W	



Package V2-Pack		Ratings				
Symbol	Definition	Conditions	min.	typ.	max.	Unit
$I_{RMS}$	RMS current	per terminal			100	A
$T_{VJ}$	virtual junction temperature		-40		150	°C
$T_{op}$	operation temperature		-40		125	°C
$T_{stg}$	storage temperature		-40		125	°C
<b>Weight</b>				76		g
$M_D$	mounting torque		2		2.5	Nm
$d_{Spp/App}$	creepage distance on surface / striking distance through air	terminal to terminal	6.0			mm
$d_{Spb/Apb}$		terminal to backside	12.0			mm
$V_{ISOL}$	isolation voltage	t = 1 second	3600			V
		t = 1 minute	3000			V



Ordering	Ordering Number	Marking on Product	Delivery Mode	Quantity	Code No.
Standard	VVZB120-16ioX	VVZB120-16ioX	Box	6	511152

Equivalent Circuits for Simulation		* on die level		$T_{VJ} = 150^{\circ}C$
		<b>Thyristor</b>	<b>Brake Diode</b>	
$V_{0\ max}$	threshold voltage	0.83	1.31	V
$R_{0\ max}$	slope resistance *	3.7	8	mΩ

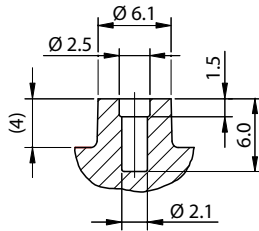


**Outlines V2-Pack**

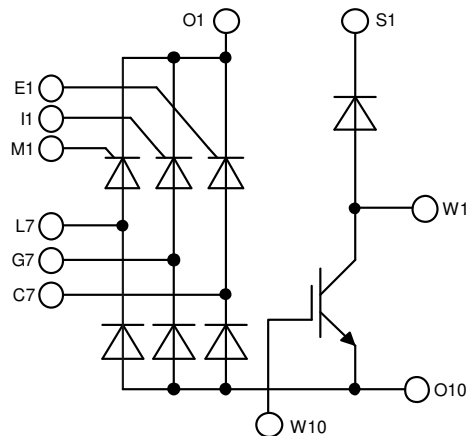
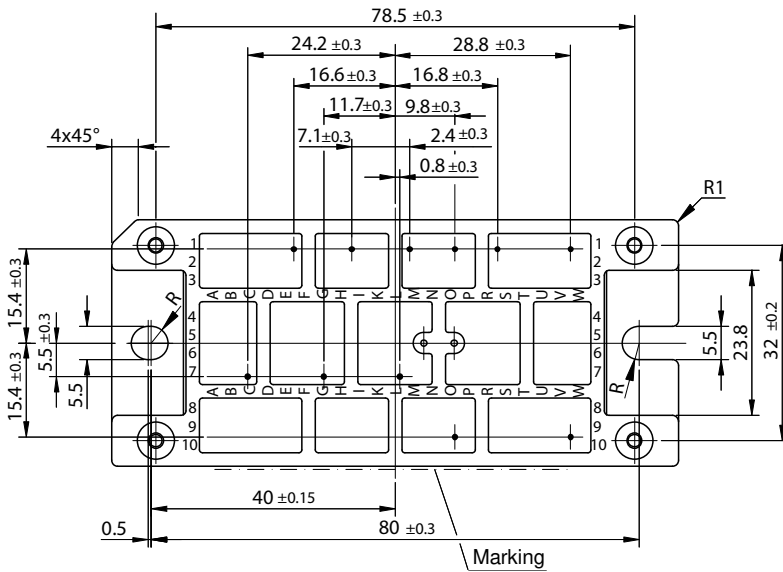
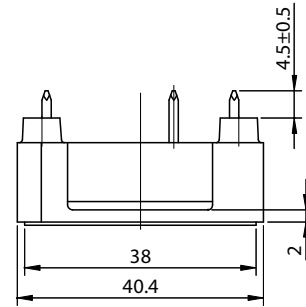
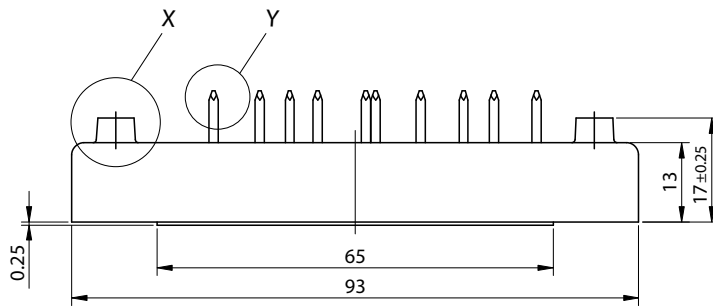
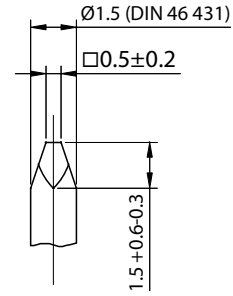
**Remarks:**

EJOT PT® self-tapping screws of the dimension K25 are recommended for the mechanical connection between module and PCB. Choose the right length according to your board thickness at a maximum depth of 6 mm of the module holes.<sup>1</sup> The recommended mounting torque is 1.5 Nm.

Detail X M 2:1



Detail Y M 5:1



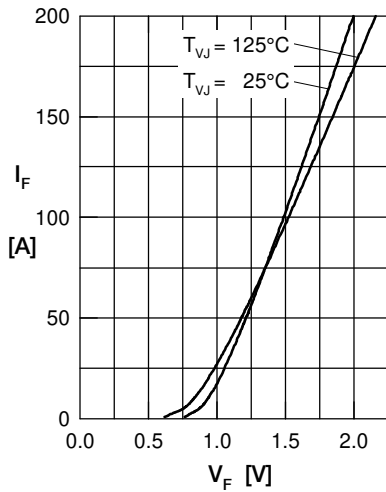
**Thyristor**


Fig. 1 Forward current vs. voltage drop per thyristor

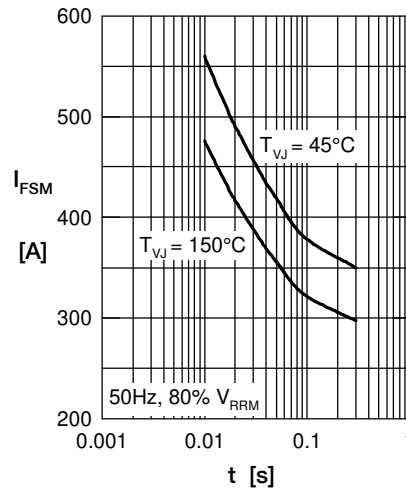


Fig. 2 Surge overload current vs. time per thyristor

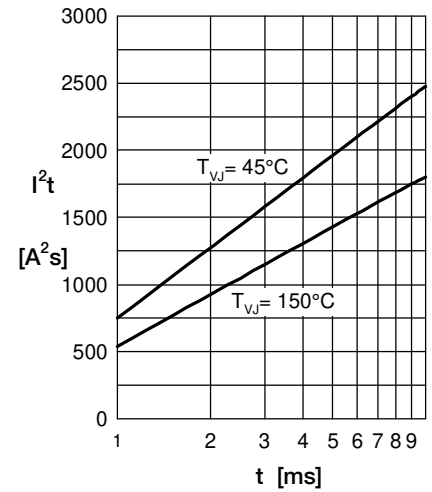
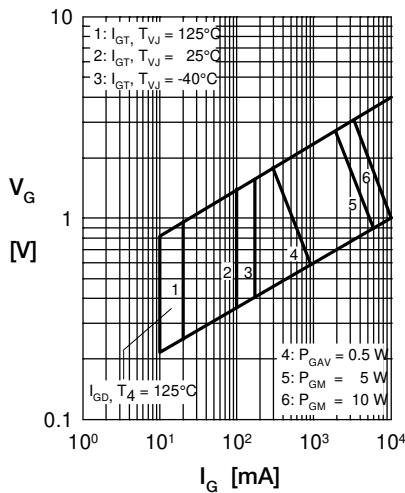

 Fig. 3  $I^2t$  vs. time per thyristor


Fig. 4 Gate trigger characteristics

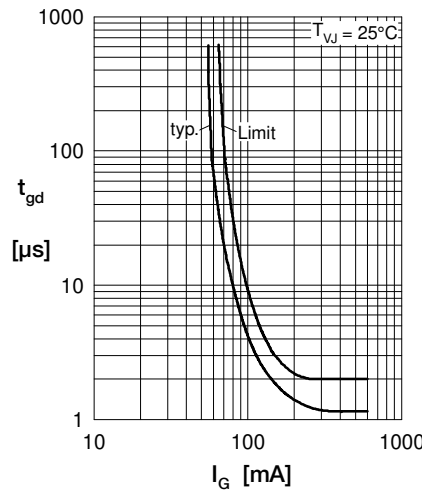


Fig. 5 Gate trigger delay time

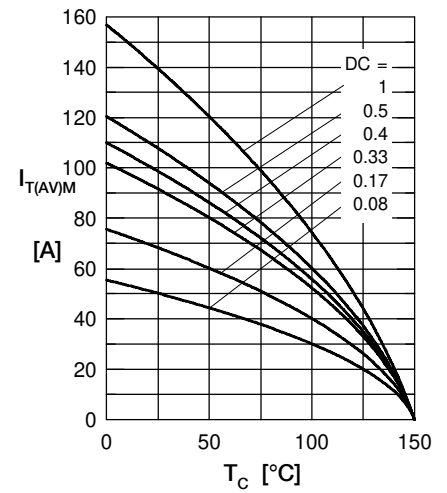


Fig. 5 Max. forward current vs. case temperature per thyristor

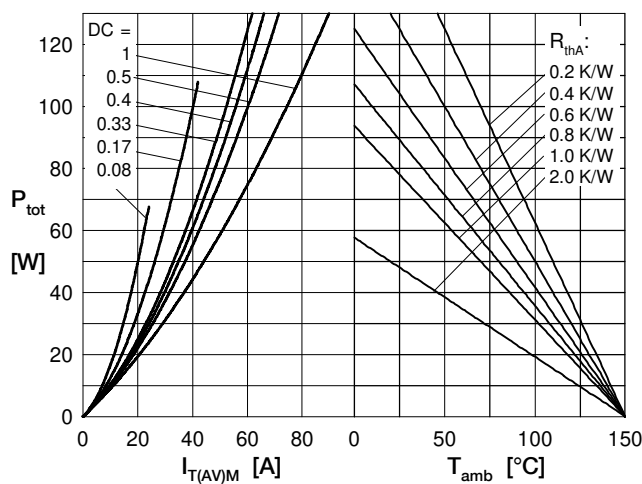


Fig. 4 Power dissipation vs. forward current and ambient temperature per thyristor

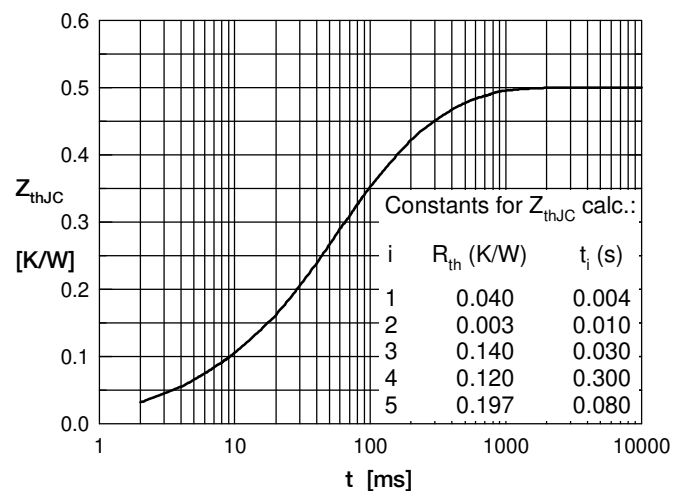


Fig. 6 Transient thermal impedance junction to case vs. time per thyristor

**Brake IGBT + Diode**


Fig.1 Output characteristics IGBT



Fig.2 Typ. output characteristics IGBT

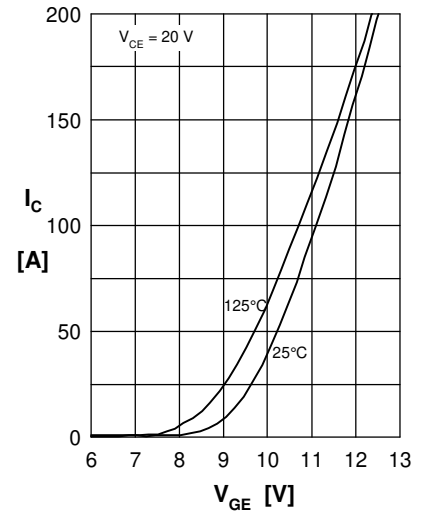


Fig.3 Typ. transfer charact. IGBT



Fig.4 Typ. turn-on energy &amp; switch. times vs. collector current



Fig.5 Typ. turn-off energy &amp; switch. times vs. collector current

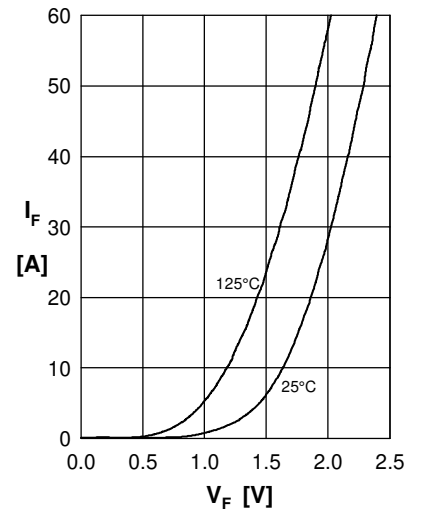


Fig.6 Typ. forward characteristics Diode

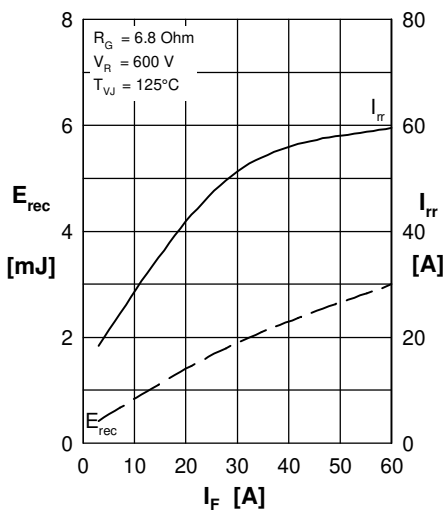


Fig.7 Typ. reverse recovery characteristics Diode

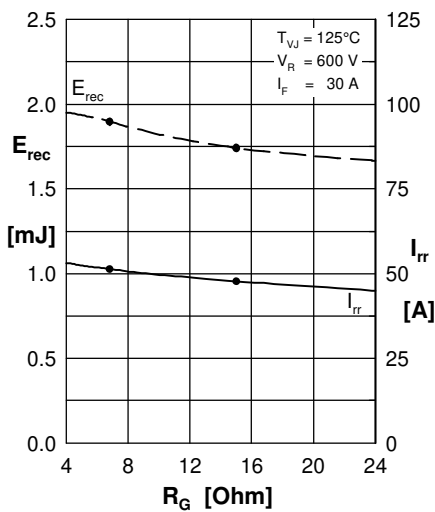


Fig.8 Typ. reverse recovery characteristics Diode

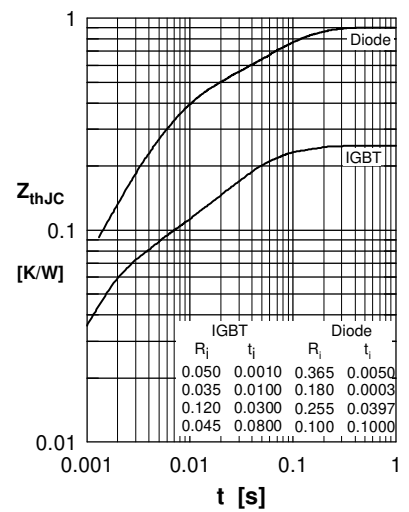


Fig.9 Transient thermal resistance junction to case