

Standard Rectifier Module

3~ Rectifier	Brake Chopper
$V_{RRM} = 1200\text{ V}$	$V_{CES} = 1200\text{ V}$
$I_{DAV} = 75\text{ A}$	$I_{C25} = 58\text{ A}$
$I_{FSM} = 600\text{ A}$	$V_{CE(sat)} = 1.85\text{ V}$

3~ Rectifier Bridge + Brake Unit + NTC

Part number

VUB72-12NOXT

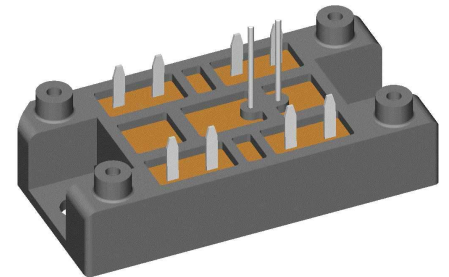

Backside: isolated

 E72873

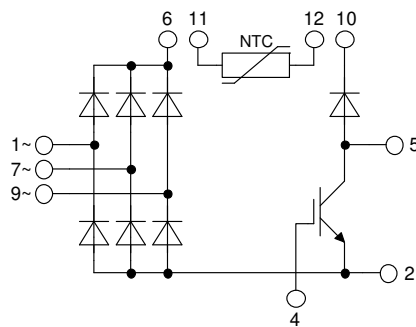

Features / Advantages:

- Package with DCB ceramic base plate
- Improved temperature and power cycling
- Planar passivated chips
- Very low forward voltage drop
- Very low leakage current
- NTC

Applications:

- 3~ Rectifier with brake unit for drive inverters

Package: V1-A-Pack

- Isolation Voltage: 3600 V~
- Industry standard outline
- RoHS compliant
- Soldering pins for PCB mounting
- Height: 17 mm
- Base plate: DCB ceramic
- Reduced weight
- Advanced power cycling

Disclaimer Notice

Information furnished is believed to be accurate and reliable. However, users should independently evaluate the suitability of and test each product selected for their own applications. Littelfuse products are not designed for, and may not be used in, all applications. Read complete Disclaimer Notice at www.littelfuse.com/disclaimer-electronics.

Rectifier				Ratings			
Symbol	Definition	Conditions		min.	typ.	max.	Unit
V_{RSM}	max. non-repetitive reverse blocking voltage					1300	V
V_{RRM}	max. repetitive reverse blocking voltage					1200	V
I_R	reverse current	$V_R = 1200$ V		$T_{VJ} = 25^\circ\text{C}$		40	μA
		$V_R = 1200$ V		$T_{VJ} = 150^\circ\text{C}$		1.5	mA
V_F	forward voltage drop	$I_F = 25$ A		$T_{VJ} = 25^\circ\text{C}$		1.10	V
		$I_F = 75$ A				1.38	V
		$I_F = 25$ A		$T_{VJ} = 125^\circ\text{C}$		1.01	V
		$I_F = 75$ A				1.37	V
I_{DAV}	bridge output current	$T_C = 110^\circ\text{C}$		$T_{VJ} = 150^\circ\text{C}$		75	A
		rectangular	$d = \frac{1}{3}$				
V_{FO}	threshold voltage			$T_{VJ} = 150^\circ\text{C}$		0.79	V
r_F	slope resistance					7.7	m Ω
R_{thJC}	thermal resistance junction to case					1.1	K/W
R_{thCH}	thermal resistance case to heatsink				0.3		K/W
P_{tot}	total power dissipation			$T_C = 25^\circ\text{C}$		110	W
I_{FSM}	max. forward surge current	$t = 10$ ms; (50 Hz), sine		$T_{VJ} = 45^\circ\text{C}$		600	A
		$t = 8,3$ ms; (60 Hz), sine		$V_R = 0$ V		650	A
		$t = 10$ ms; (50 Hz), sine		$T_{VJ} = 150^\circ\text{C}$		510	A
		$t = 8,3$ ms; (60 Hz), sine		$V_R = 0$ V		550	A
I^2t	value for fusing	$t = 10$ ms; (50 Hz), sine		$T_{VJ} = 45^\circ\text{C}$		1.80	kA ² s
		$t = 8,3$ ms; (60 Hz), sine		$V_R = 0$ V		1.76	kA ² s
		$t = 10$ ms; (50 Hz), sine		$T_{VJ} = 150^\circ\text{C}$		1.30	kA ² s
		$t = 8,3$ ms; (60 Hz), sine		$V_R = 0$ V		1.26	kA ² s
C_J	junction capacitance	$V_R = 400$ V; $f = 1$ MHz		$T_{VJ} = 25^\circ\text{C}$		19	pF



Brake IGBT				Ratings					
Symbol	Definition	Conditions	min.	typ.	max.	Unit			
V_{CES}	collector emitter voltage	$T_{VJ} = 25^{\circ}C$			1200	V			
V_{GES}	max. DC gate voltage				± 20	V			
V_{GEM}	max. transient gate emitter voltage				± 30	V			
I_{C25}	collector current	$T_C = 25^{\circ}C$			58	A			
I_{C80}		$T_C = 80^{\circ}C$			40	A			
P_{tot}	total power dissipation	$T_C = 25^{\circ}C$			195	W			
$V_{CE(sat)}$	collector emitter saturation voltage	$I_C = 35\text{ A}; V_{GE} = 15\text{ V}$			1.85	V			
					2.15	V			
$V_{GE(th)}$	gate emitter threshold voltage	$I_C = 2\text{ mA}; V_{GE} = V_{CE}$	5.4	5.9	6.5	V			
I_{CES}	collector emitter leakage current	$V_{CE} = V_{CES}; V_{GE} = 0\text{ V}$			0.1	mA			
					0.1	mA			
I_{GES}	gate emitter leakage current	$V_{GE} = \pm 20\text{ V}$			500	nA			
$Q_{G(on)}$	total gate charge	$V_{CE} = 600\text{ V}; V_{GE} = 15\text{ V}; I_C = 35\text{ A}$			110	nC			
$t_{d(on)}$	turn-on delay time	inductive load $V_{CE} = 600\text{ V}; I_C = 35\text{ A}$ $V_{GE} = \pm 15\text{ V}; R_G = 27\ \Omega$							
t_r	current rise time						$T_{VJ} = 125^{\circ}C$	70	ns
$t_{d(off)}$	turn-off delay time						40	ns	
t_f	current fall time						250	ns	
E_{on}	turn-on energy per pulse						100	ns	
E_{off}	turn-off energy per pulse						3.8	mJ	
E_{off}		4.1	mJ						
RBSOA	reverse bias safe operating area	$V_{GE} = \pm 15\text{ V}; R_G = 27\ \Omega$							
I_{CM}		$V_{CEK} = 1200\text{ V}$			105	A			
SCSOA	short circuit safe operating area	$V_{CEK} = 1200\text{ V}$							
t_{SC}	short circuit duration	$V_{CE} = 900\text{ V}; V_{GE} = \pm 15$			10	μs			
I_{SC}	short circuit current	$R_G = 27\ \Omega$; non-repetitive			140	A			
R_{thJC}	thermal resistance junction to case				0.65	K/W			
R_{thCH}	thermal resistance case to heatsink				0.25	K/W			
Brake Diode									
V_{RRM}	max. repetitive reverse voltage	$T_{VJ} = 25^{\circ}C$			1200	V			
I_{F25}	forward current	$T_C = 25^{\circ}C$			31	A			
I_{F80}		$T_C = 80^{\circ}C$			21	A			
V_F	forward voltage	$I_F = 25\text{ A}$			2.97	V			
					2.43	V			
I_R	reverse current	$V_R = V_{RRM}$			0.1	mA			
					0.5	mA			
Q_{rr}	reverse recovery charge	$V_R = 600\text{ V}$ $-di_f/dt = 400\text{ A}/\mu s$ $I_F = 25\text{ A}; V_{GE} = 0\text{ V}$							
I_{RM}	max. reverse recovery current						$T_{VJ} = 125^{\circ}C$	1.2	μC
t_{rr}	reverse recovery time						18	A	
R_{thJC}	thermal resistance junction to case				1.6	K/W			
R_{thCH}	thermal resistance case to heatsink				0.55	K/W			



Package V1-A-Pack				Ratings		
Symbol	Definition	Conditions	min.	typ.	max.	Unit
I_{RMS}	RMS current	per terminal			100	A
T_{VJ}	virtual junction temperature		-40		150	°C
T_{op}	operation temperature		-40		125	°C
T_{stg}	storage temperature		-40		125	°C
Weight				37		g
M_D	mounting torque		2		2.5	Nm
$d_{Spp/APP}$	creepage distance on surface / striking distance through air	terminal to terminal	6.0			mm
$d_{Spb/APb}$		terminal to backside	12.0			mm
V_{ISOL}	isolation voltage	t = 1 second 50/60 Hz, RMS; $I_{ISOL} \leq 1$ mA	3600			V
		t = 1 minute	3000			V

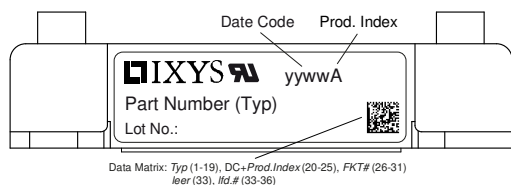

Ordering	Ordering Number	Marking on Product	Delivery Mode	Quantity	Code No.
Standard	VUB72-12NOXT	VUB72-12NOXT	Blister	24	515901

Similar Part	Package	Voltage class
VUB72-16NOXT	V1-A-Pack	1600

Temperature Sensor NTC

Symbol	Definition	Conditions	min.	typ.	max.	Unit
R_{25}	resistance	$T_{VJ} = 25^\circ$	2.13	2.2	2.27	kΩ
$B_{25/50}$	temperature coefficient			3560		K

Equivalent Circuits for Simulation

* on die level

$T_{VJ} = 150^\circ\text{C}$

		Rectifier	Brake IGBT	Brake Diode	
V_0	threshold voltage	0.79	1.1	1.16	V
R_0	slope resistance *	6.5	40	43	mΩ

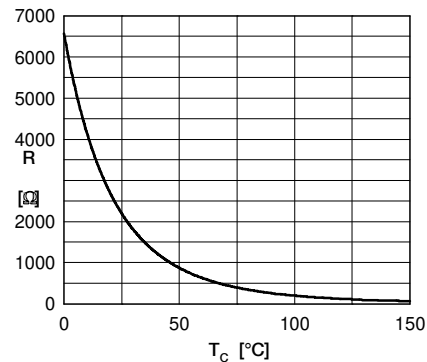



Outlines V1-A-Pack

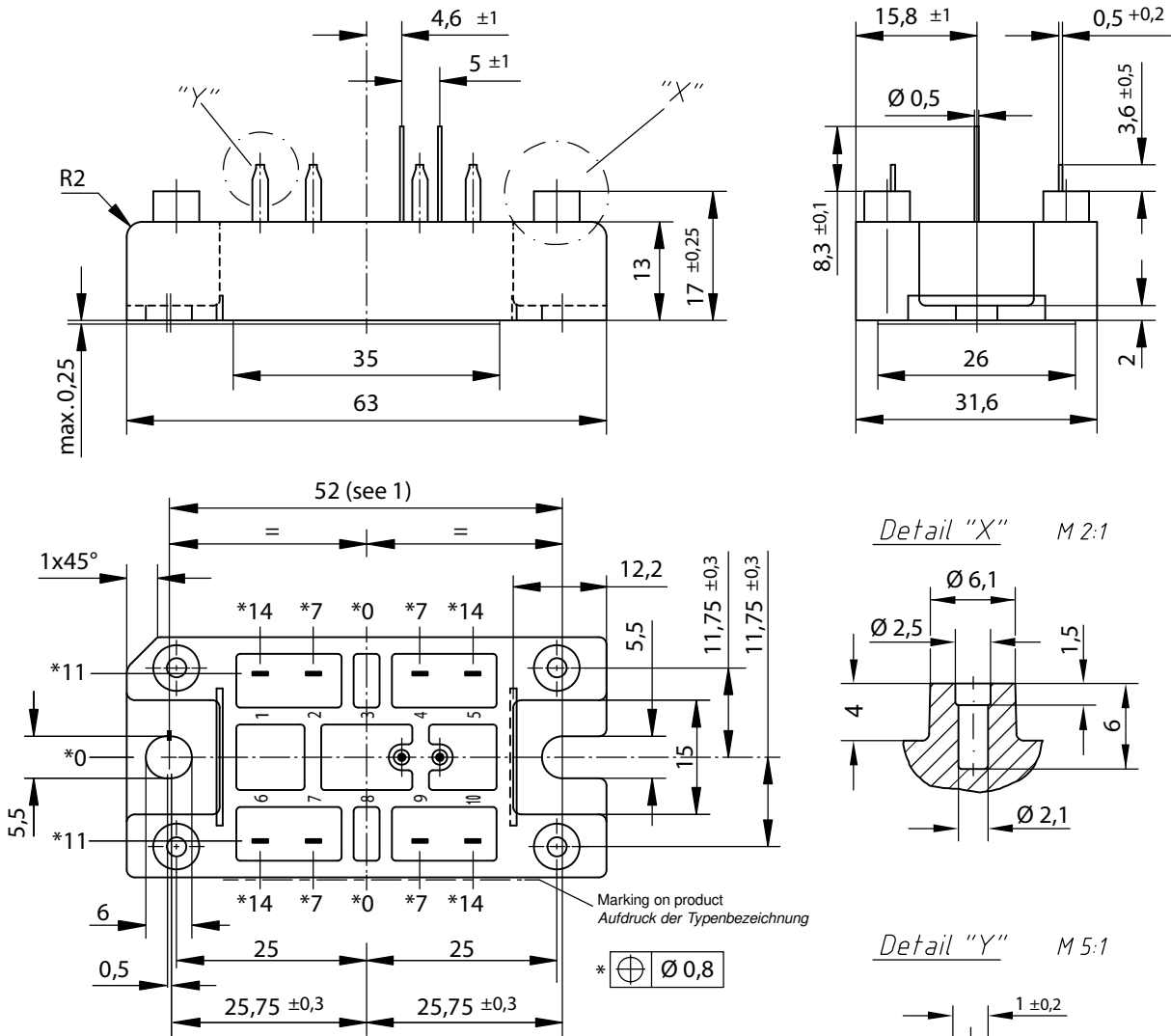

Remarks / Bemerkungen:

1. Nominal distance mounting screws on heat sink: 52 mm / Nennabstand Befestigungsschrauben auf Kühlkörper: 52 mm
2. General tolerance / Allgmeintoleranz: DIN ISO 2768 - T1-c
3. Surface treatment of pins: tin plated (Sn) in hot dip / Oberflächenbehandlung der Pins: verzinkt (Sn) im Tauchbad
4. **Detail X:**
EJOT PT® self-tapping screws (dimension K25) to be recommended for mounting on PCB
selbstschneidende Schraube (Größe K25) empfohlen für die PCB-Montage
Take care on the maximum screw length according to board thickness and the maximum hole depth of 6 mm⁻¹
Bei der Wahl der Schraubenlänge die PCB-Dicke und die maximale Lochtiefe von 6mm beachten
Recommended mounting torque: 1.5 Nm / Empfohlenes Drehmoment: 1.5 Nm

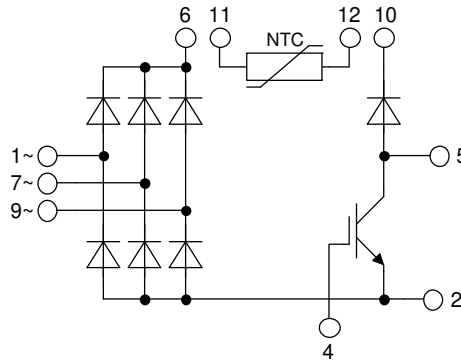



Rectifier

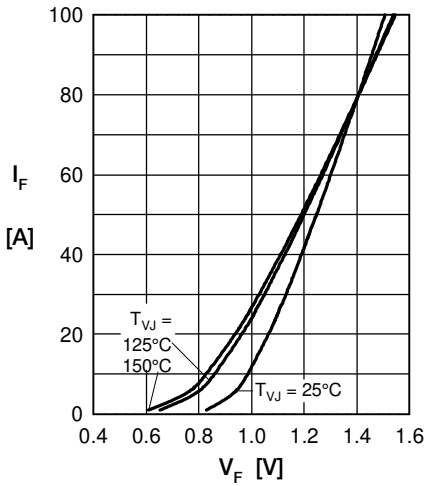

Fig. 1 Forward current vs. voltage drop per diode

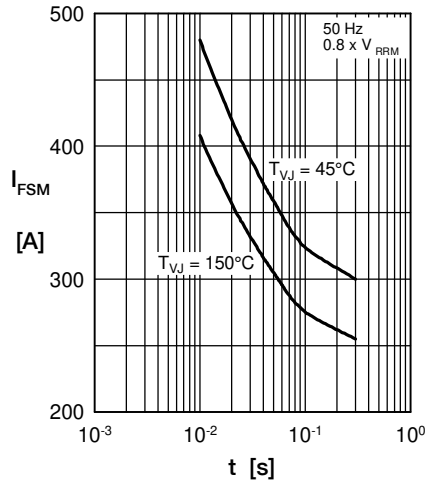

Fig. 2 Surge overload current vs. time per diode

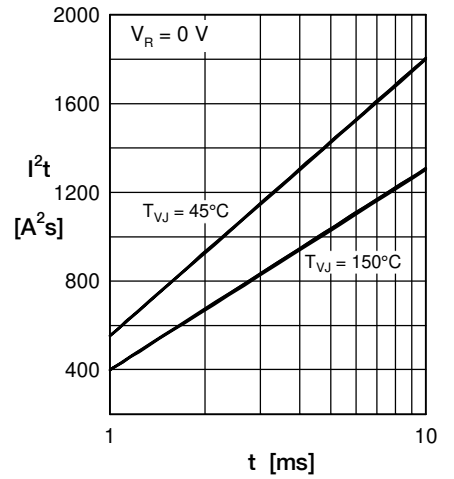

Fig. 3 I^2t vs. time per diode

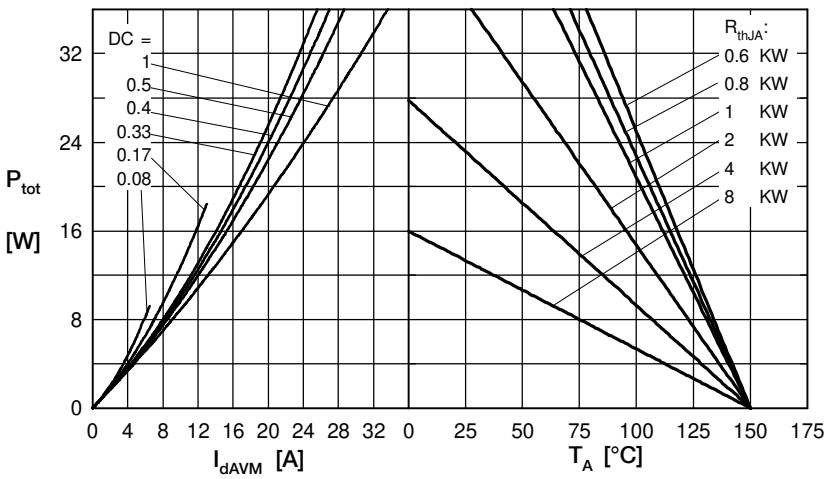

Fig. 4 Power dissipation vs. forward current and ambient temperature per diode

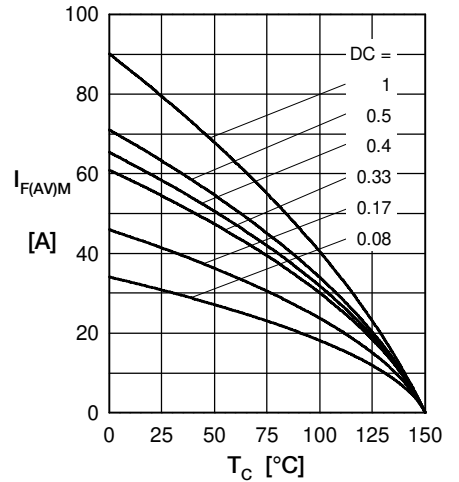

Fig. 5 Max. forward current vs. case temperature per diode

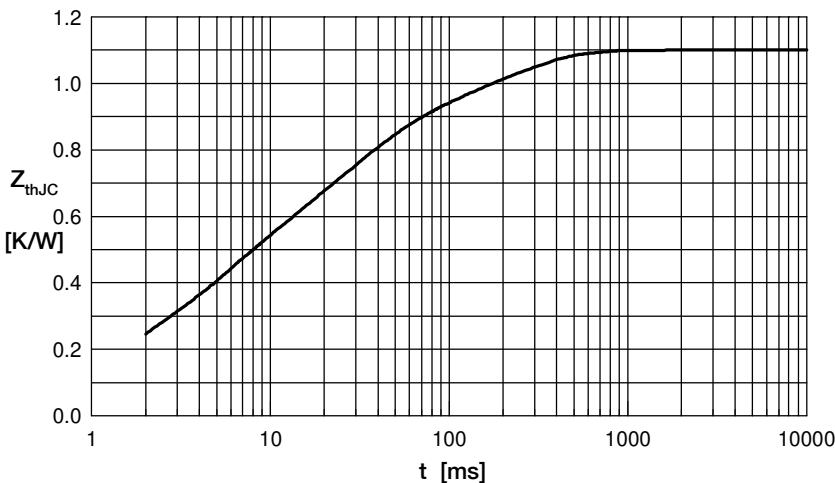
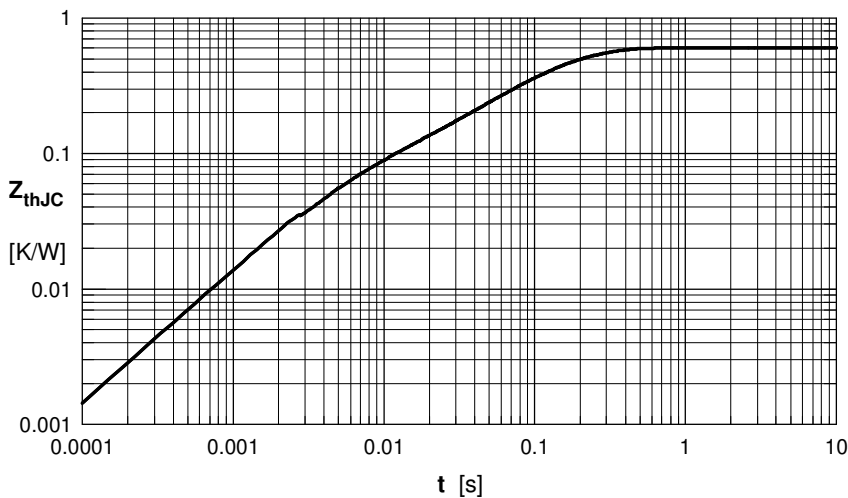
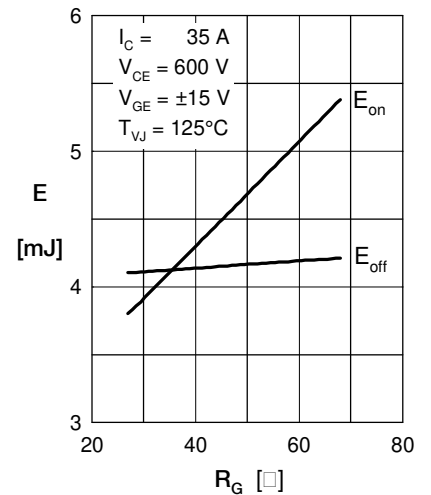
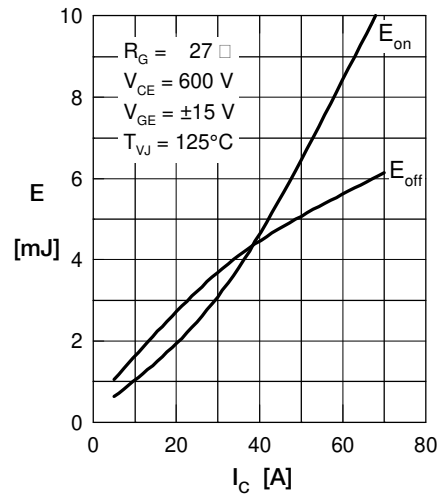
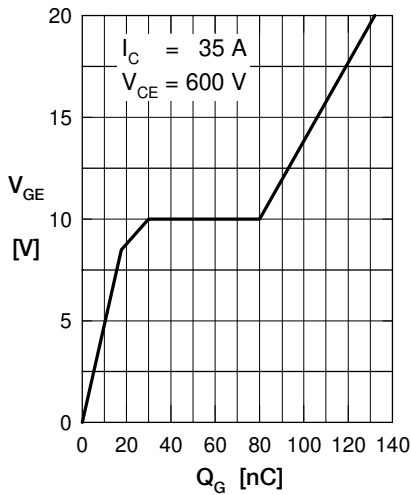
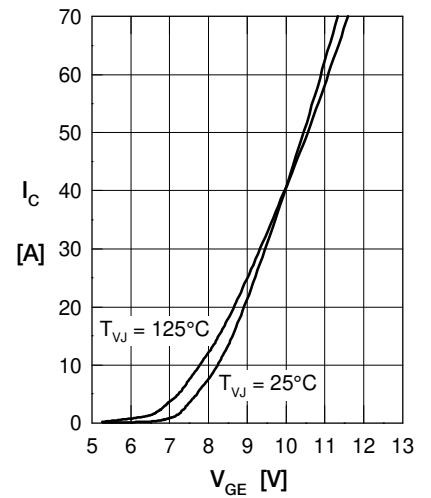
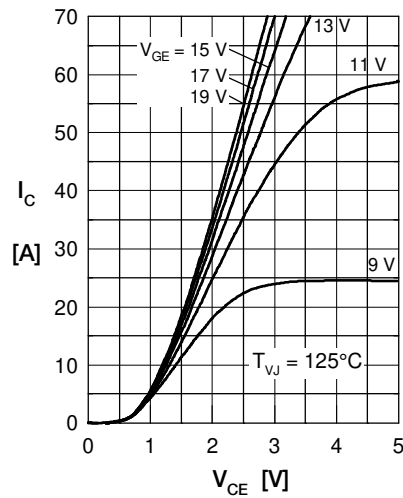
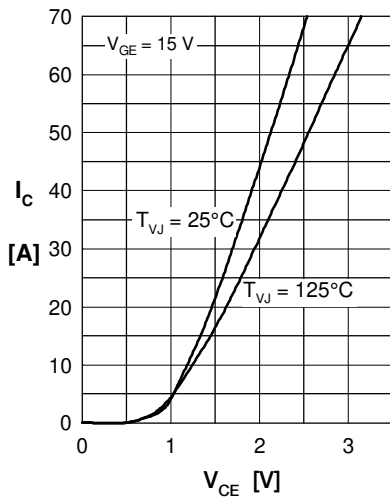

Fig. 6 Transient thermal impedance junction to case vs. time per diode

Constants for Z_{thJC} calculation:

i	R_{th} (K/W)	t_i (s)
1	0.0607	0.0004
2	0.1230	0.00256
3	0.2305	0.0045
4	0.4230	0.0242
5	0.2628	0.1800

Brake IGBT

Brake Diode

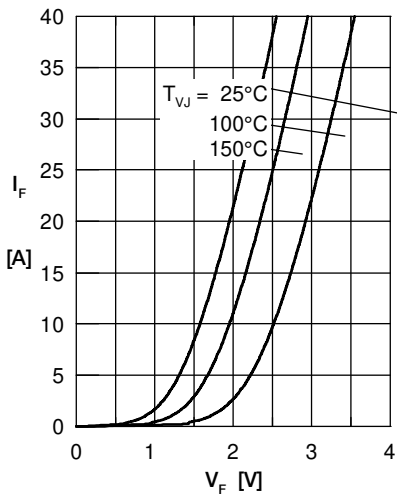

Fig. 1 Forward current I_F versus V_F

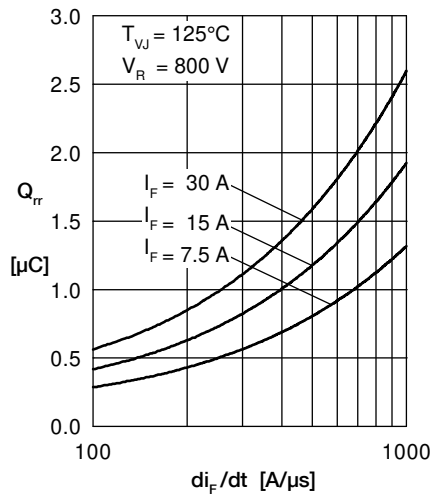

Fig. 2 Typ. reverse recov. charge Q_{rr} versus di_F/dt

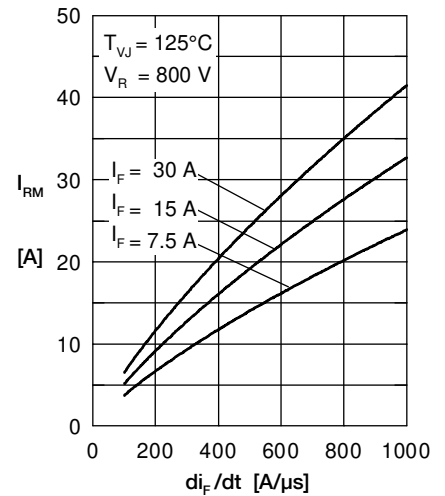

Fig. 3 Typ. peak reverse current I_{RM} versus di_F/dt

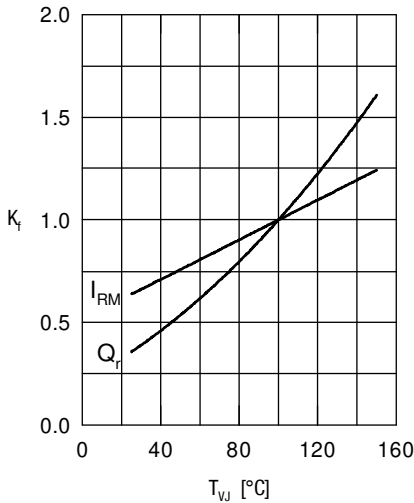

Fig. 4 Dynamic parameters Q_r , I_{RM} versus T_{VJ}

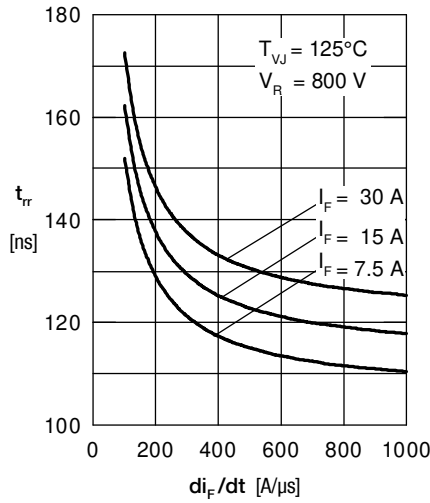

Fig. 5 Typ. recovery time t_{rr} versus di_F/dt

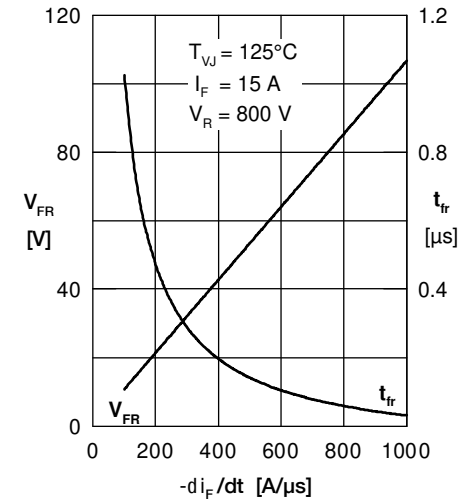

Fig. 6 Typ. peak forward voltage V_{FR} and t_{fr} versus di_F/dt

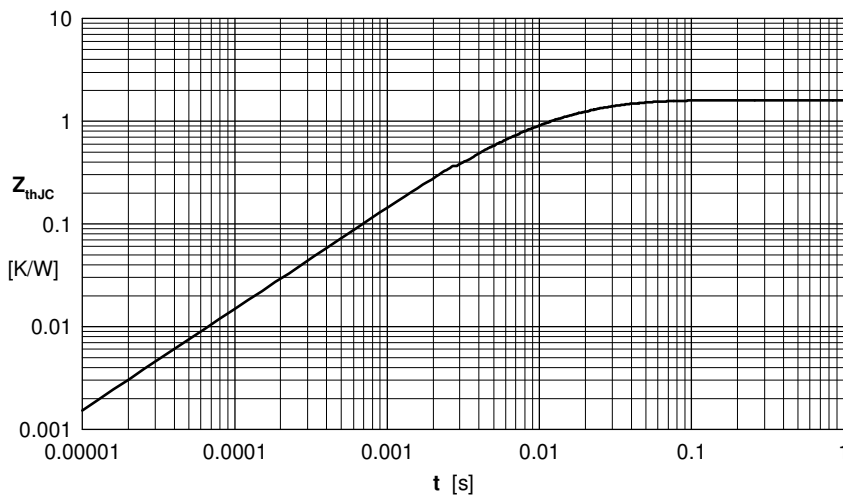

Fig. 7 Transient thermal impedance junction to case