

Standard Rectifier Module

| 1~ Rectifier | |
|-----------------|---------|
| V_{RRM} | = 800 V |
| I_{DAV} | = 20 A |
| I_{FSM} | = 120 A |

1~ Rectifier Bridge

Part number

VBO21-08NO7



 E72873



Features / Advantages:

- Package with DCB ceramic
- Improved temperature and power cycling
- Planar passivated chips
- Very low forward voltage drop
- Very low leakage current

Applications:

- Diode for main rectification
- For one phase bridge configurations
- Supplies for DC power equipment
- Input rectifiers for PWM inverter
- Battery DC power supplies
- Field supply for DC motors

Package: ECO-PAC1

- Isolation Voltage: 3000 V~
- Industry standard outline
- RoHS compliant
- Soldering pins for PCB mounting
- Height: 9 mm
- Base plate: DCB ceramic
- Reduced weight
- Advanced power cycling

Disclaimer Notice

Information furnished is believed to be accurate and reliable. However, users should independently evaluate the suitability of and test each product selected for their own applications. Littelfuse products are not designed for, and may not be used in, all applications. Read complete Disclaimer Notice at www.littelfuse.com/disclaimer-electronics.



| Rectifier | | | | Ratings | | | |
|------------|--|---|-----------|------------------------------|------|-----------------------------------|------------------|
| Symbol | Definition | Conditions | | min. | typ. | max. | Unit |
| V_{RSM} | max. non-repetitive reverse blocking voltage | | | | | 900 | V |
| V_{RRM} | max. repetitive reverse blocking voltage | | | | | 800 | V |
| I_R | reverse current | $V_R = 800\text{ V}$ | | $T_{VJ} = 25^\circ\text{C}$ | | 10 | μA |
| | | $V_R = 800\text{ V}$ | | $T_{VJ} = 150^\circ\text{C}$ | | 0.7 | mA |
| V_F | forward voltage drop | $I_F = 10\text{ A}$ | | $T_{VJ} = 25^\circ\text{C}$ | | 1.20 | V |
| | | $I_F = 20\text{ A}$ | | | | 1.41 | V |
| | | $I_F = 10\text{ A}$ | | $T_{VJ} = 125^\circ\text{C}$ | | 1.14 | V |
| | | $I_F = 20\text{ A}$ | | | | 1.42 | V |
| I_{DAV} | bridge output current | $T_C = 115^\circ\text{C}$ | | $T_{VJ} = 150^\circ\text{C}$ | | 20 | A |
| | | rectangular | $d = 0.5$ | | | | |
| V_{F0} | threshold voltage | | | $T_{VJ} = 150^\circ\text{C}$ | | 0.84 | V |
| r_F | slope resistance | | | | | 28.8 | m Ω |
| | | | | | | } for power loss calculation only | |
| R_{thJC} | thermal resistance junction to case | | | | | 2.5 | K/W |
| R_{thCH} | thermal resistance case to heatsink | | | | 0.4 | | K/W |
| P_{tot} | total power dissipation | | | $T_C = 25^\circ\text{C}$ | | 50 | W |
| I_{FSM} | max. forward surge current | $t = 10\text{ ms}; (50\text{ Hz}), \text{ sine}$ | | $T_{VJ} = 45^\circ\text{C}$ | | 120 | A |
| | | $t = 8,3\text{ ms}; (60\text{ Hz}), \text{ sine}$ | | $V_R = 0\text{ V}$ | | 130 | A |
| | | $t = 10\text{ ms}; (50\text{ Hz}), \text{ sine}$ | | $T_{VJ} = 150^\circ\text{C}$ | | 100 | A |
| | | $t = 8,3\text{ ms}; (60\text{ Hz}), \text{ sine}$ | | $V_R = 0\text{ V}$ | | 110 | A |
| I^2t | value for fusing | $t = 10\text{ ms}; (50\text{ Hz}), \text{ sine}$ | | $T_{VJ} = 45^\circ\text{C}$ | | 72 | A ² s |
| | | $t = 8,3\text{ ms}; (60\text{ Hz}), \text{ sine}$ | | $V_R = 0\text{ V}$ | | 70 | A ² s |
| | | $t = 10\text{ ms}; (50\text{ Hz}), \text{ sine}$ | | $T_{VJ} = 150^\circ\text{C}$ | | 50 | A ² s |
| | | $t = 8,3\text{ ms}; (60\text{ Hz}), \text{ sine}$ | | $V_R = 0\text{ V}$ | | 50 | A ² s |
| C_J | junction capacitance | $V_R = 400\text{ V}; f = 1\text{ MHz}$ | | $T_{VJ} = 25^\circ\text{C}$ | | 4 | pF |



| Package ECO-PAC1 | | Ratings | | | | |
|------------------|--|----------------------|------|------|------|------|
| Symbol | Definition | Conditions | min. | typ. | max. | Unit |
| I_{RMS} | RMS current | per terminal | | | 100 | A |
| T_{VJ} | virtual junction temperature | | -40 | | 150 | °C |
| T_{op} | operation temperature | | -40 | | 125 | °C |
| T_{stg} | storage temperature | | -40 | | 125 | °C |
| Weight | | | | 19 | | g |
| M_D | mounting torque | | 1.4 | | 2 | Nm |
| $d_{Spp/App}$ | creepage distance on surface / striking distance through air | terminal to terminal | 6.0 | | | mm |
| $d_{Spb/Apb}$ | | terminal to backside | 10.0 | | | mm |
| V_{ISOL} | isolation voltage | t = 1 second | 3000 | | | V |
| | | t = 1 minute | 2500 | | | V |



| Ordering | Ordering Number | Marking on Product | Delivery Mode | Quantity | Code No. |
|----------|-----------------|--------------------|---------------|----------|----------|
| Standard | VBO21-08NO7 | VBO21-08NO7 | Box | 25 | 491411 |

Equivalent Circuits for Simulation

* on die level

$T_{VJ} = 150^{\circ}C$



Rectifier

| | | | |
|--------------|--------------------|------|----|
| $V_{0\ max}$ | threshold voltage | 0.84 | V |
| $R_{0\ max}$ | slope resistance * | 27.6 | mΩ |



Outlines ECO-PAC1

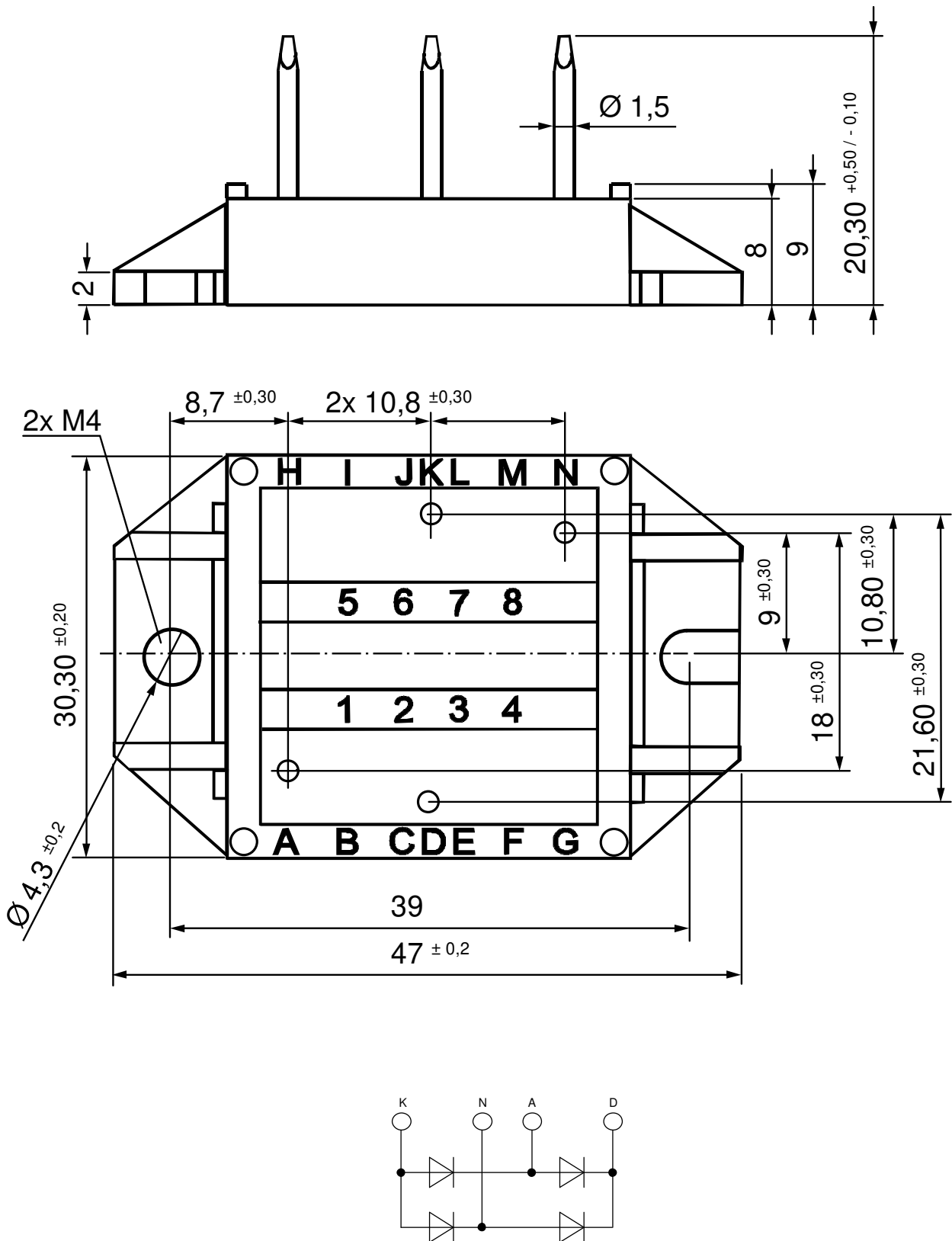



Rectifier

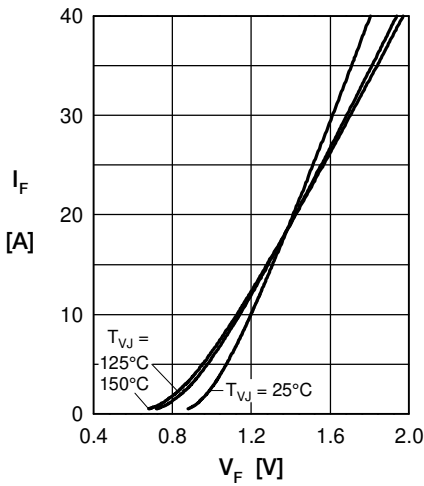

Fig. 1 Forward current vs. voltage drop per diode

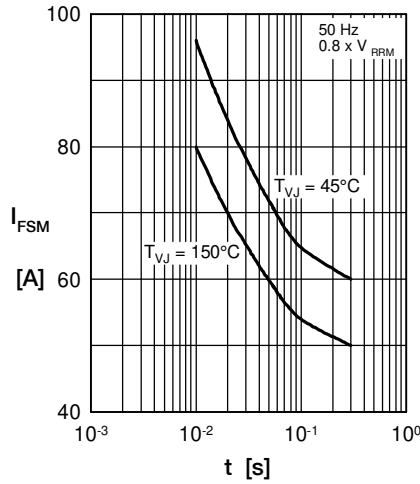

Fig. 2 Surge overload current vs. time per diode

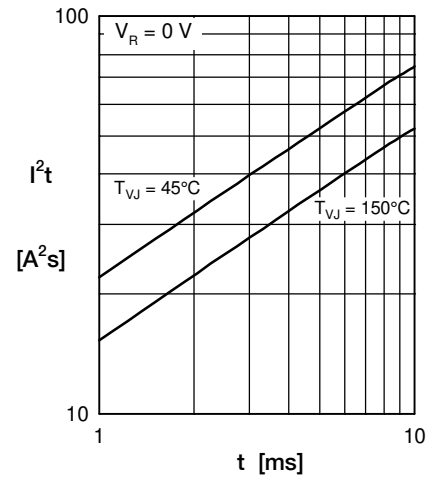

Fig. 3 I^2t vs. time per diode

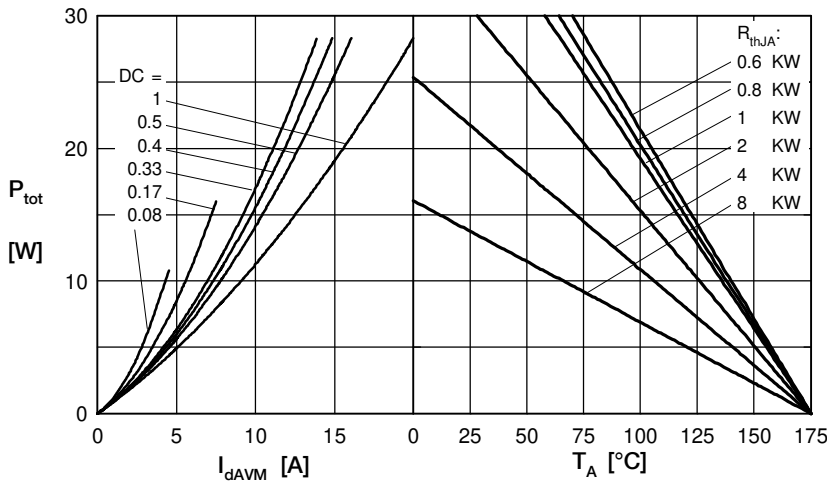

Fig. 4 Power dissipation vs. forward current and ambient temperature per diode

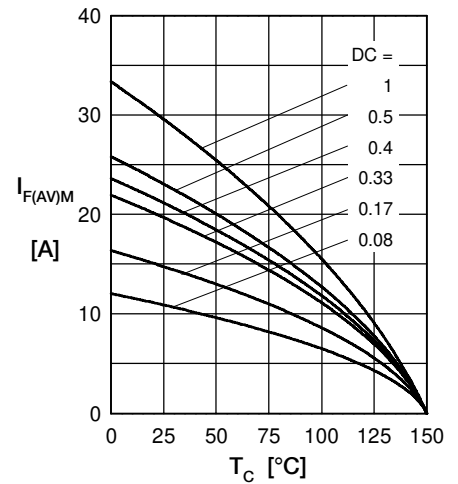

Fig. 5 Max. forward current vs. case temperature per diode

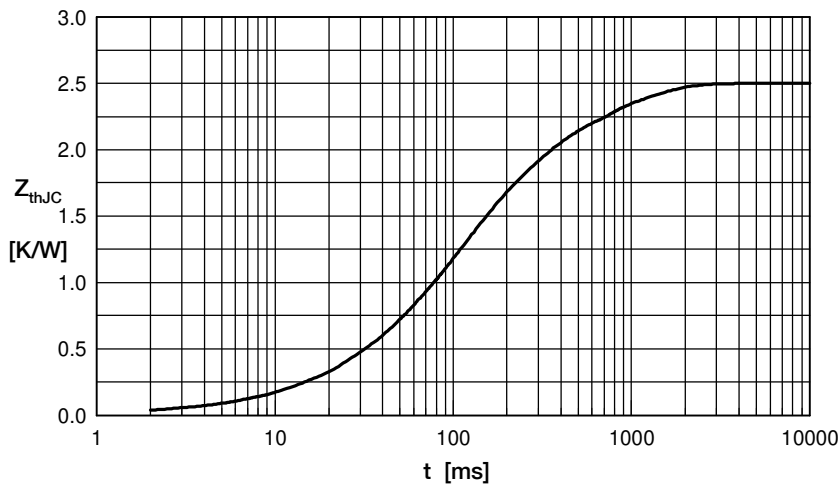

Fig. 6 Transient thermal impedance junction to case vs. time per diode

Constants for Z_{thJC} calculation:

| i | R_{th} (K/W) | t_i (s) |
|---|----------------|-----------|
| 1 | 1.359 | 0.1015 |
| 2 | 0.3286 | 0.1026 |
| 3 | 0.1651 | 0.4919 |
| 4 | 0.6473 | 0.62 |