

Converter - Brake - Inverter Module (CBI3) with Trench IGBT technology

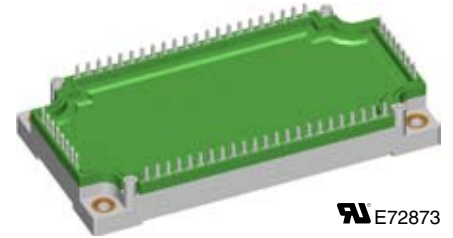
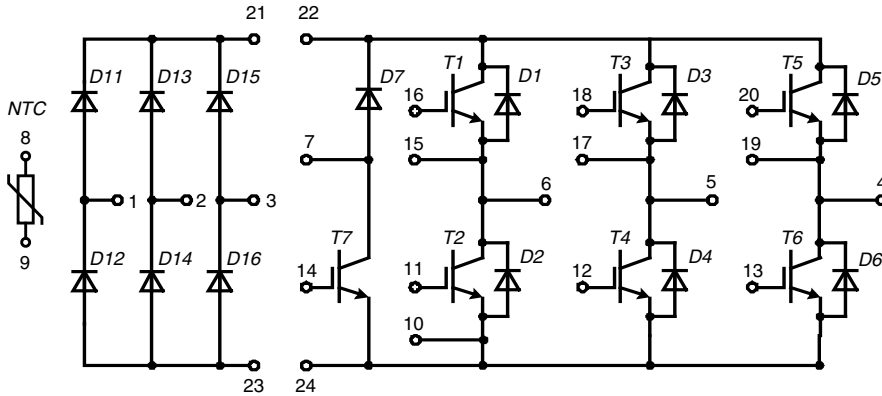

E72873

Three Phase Rectifier	Brake Chopper	Three Phase Inverter
$V_{RRM} = 2200 \text{ V}$	$V_{CES} = 1700 \text{ V}$	$V_{CES} = 1700 \text{ V}$
$I_{FAVM} = 70 \text{ A}$	$I_{C25} = 48 \text{ A}$	$I_{C25} = 113 \text{ A}$
$I_{FSM} = 700 \text{ A}$	$V_{CE(sat)} = 1.8 \text{ V}$	$V_{CE(sat)} = 2.0 \text{ V}$

Input Rectifier Bridge D11 - D16		
Symbol	Conditions	Maximum Ratings
V_{RRM}		2200 V
I_{FAV}	$T_C = 80^\circ\text{C}$; sine 180°	50 A
I_{DAVM}	$T_C = 80^\circ\text{C}$; rectangular; $d = 1/3$; bridge	155 A
I_{FSM}	$T_C = 25^\circ\text{C}$; $t = 10 \text{ ms}$; sine 50 Hz	700 A
P_{tot}	$T_C = 25^\circ\text{C}$	130 W

Symbol	Conditions	Characteristic Values			
		(T _{VJ} = 25°C, unless otherwise specified)			
		min.	typ.	max.	
V_F	$I_F = 75 \text{ A}$; $T_{VJ} = 25^\circ\text{C}$		1.4	1.5	V
		$T_{VJ} = 125^\circ\text{C}$		1.3	
I_R	$V_R = V_{RRM}$; $T_{VJ} = 25^\circ\text{C}$		1.5	0.05	mA
	$T_{VJ} = 125^\circ\text{C}$				mA
R_{thJC}	(per diode)			0.95	K/W

Application: AC motor drives with

- Input from single or three phase grid
- Three phase synchronous or asynchronous motor
- Electric braking operation

Features

- High level of integration - only one power semiconductor module required for the whole drive
- IGBT technology with low saturation voltage, low switching losses and tail current, high RBSOA and short circuit ruggedness
- Epitaxial free wheeling diodes with Hiperfast and soft reverse recovery
- Industry standard package with insulated copper base plate and soldering pins for PCB mounting
- Temperature sense included

Output Inverter T1 - T6

Symbol	Conditions	Maximum Ratings	
V_{CES}	$T_{VJ} = 25^{\circ}\text{C}$ to 150°C	1700	V
V_{GES}	Continuous	± 20	V
I_{C25}	$T_C = 25^{\circ}\text{C}$	113	A
I_{C80}	$T_C = 80^{\circ}\text{C}$	80	A
I_{CM}	$T_C = 80^{\circ}\text{C}$; $t_p = 1$ ms	150	A
P_{tot}	$T_C = 25^{\circ}\text{C}$	450	W

Symbol	Conditions	Characteristic Values				
		(T _{VJ} = 25°C, unless otherwise specified)				
		min.	typ.	max.		
$V_{CE(sat)}$	$I_C = 75$ A; $V_{GE} = 15$ V	$T_{VJ} = 25^{\circ}\text{C}$		2.0	2.4	V
		$T_{VJ} = 125^{\circ}\text{C}$		2.4		V
$V_{GE(th)}$	$I_C = 3$ mA; $V_{GE} = V_{CE}$	5		6.5	V	
I_{CES}	$V_{CE} = V_{CES}$; $V_{GE} = 0$ V		2.0	0.8	mA	
					mA	
I_{GES}	$V_{CE} = 0$ V; $V_{GE} = \pm 20$ V			400	nA	
C_{iss}	$V_{CE} = 25$ V; $V_{GE} = 0$ V; $f = 1$ MHz		6.6		nF	
Q_{Gon}	$V_{CE} = 900$ V; $V_{GE} = 15$ V; $I_C = 75$ A		850		nC	
$t_{d(on)}$ t_r $t_{d(off)}$ t_f E_{on} E_{off}	Inductive load, $T_{VJ} = 125^{\circ}\text{C}$ $V_{CE} = 900$ V; $I_C = 75$ A $V_{GE} = \pm 15$ V; $R_G = 18$ Ω		300		ns	
			60		ns	
			850		ns	
			500		ns	
			30		mJ	
			25		mJ	
RBSOA	$I_C = I_{CM}$; $V_{GE} = 15$ V $R_G = 18$ Ω ; $T_{VJ} = 125^{\circ}\text{C}$	$V_{CEK} \leq V_{CES} - L_S di/dt$			V	
t_{SC} (SCSOA)	$V_{CE} = 1000$ V; $V_{GE} = \pm 15$ V; $R_G = 18$ Ω $t_p \leq 10$ μs ; non-repetitive; $T_{VJ} = 125^{\circ}\text{C}$		10		μs	
R_{thJC}				0.28	K/W	

Output Inverter D1 - D6

Symbol	Conditions	Maximum Ratings	
I_{F25}	$T_C = 25^{\circ}\text{C}$	92	A
I_{F80}	$T_C = 80^{\circ}\text{C}$	63	A

Symbol	Conditions	Characteristic Values				
		min.	typ.	max.		
V_F	$I_F = 75$ A;	$T_{VJ} = 25^{\circ}\text{C}$		2.2	2.9	V
		$T_{VJ} = 125^{\circ}\text{C}$		2.3		V
I_{RM}	$I_F = 75$ A; $di_F/dt = -1400$ A/ μs ; $T_{VJ} = 125^{\circ}\text{C}$; $V_R = 900$ V; $V_{GE} = 0$ V		95		A	
Q_{rr}		20		μC		
t_{rr}		800		ns		
E_{rec}		10		mJ		
R_{thJC}	(per diode)			0.4	K/W	

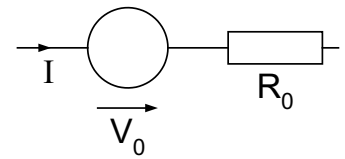
Equivalent Circuits for Simulation
Conduction

IGBT (typ. at $V_{GE} = 15$ V; $T_J = 125^{\circ}\text{C}$)
T1-T6

$$V_0 = 1.0 \text{ V}; R_0 = 17 \text{ m}\Omega$$

T7

$$V_0 = 1.0 \text{ V}; R_0 = 28 \text{ m}\Omega$$

Diode (typ. at $T_J = 125^{\circ}\text{C}$)
D1-D6

$$V_0 = 1.4 \text{ V}; R_0 = 11 \text{ m}\Omega$$

D7

$$V_0 = 1.65 \text{ V}; R_0 = 37 \text{ m}\Omega$$

D11-D16

$$V_0 = 0.85 \text{ V}; R_0 = 2.8 \text{ m}\Omega$$

Brake Chopper T7			
Symbol	Conditions	Maximum Ratings	
V_{CES}	$T_{VJ} = 25^{\circ}\text{C}$ to 150°C	1700	V
V_{GES}	Continuous	± 20	V
I_{C25}	$T_C = 25^{\circ}\text{C}$	48	A
I_{C80}	$T_C = 80^{\circ}\text{C}$	34	A
I_{CM}	$T_C = 80^{\circ}\text{C}$; $t_p = 1$ ms	60	A
P_{tot}	$T_C = 25^{\circ}\text{C}$	200	W

Symbol	Conditions	Characteristic Values			
		min.	typ.	max.	
($T_{VJ} = 25^{\circ}\text{C}$, unless otherwise specified)					
$V_{CE(sat)}$	$I_C = 30$ A; $V_{GE} = 15$ V	$T_{VJ} = 25^{\circ}\text{C}$	1.9	2.2	V
		$T_{VJ} = 125^{\circ}\text{C}$	2.1		V
$V_{GE(th)}$	$I_C = 2$ mA; $V_{GE} = V_{CE}$	5		6.5	V
I_{CES}	$V_{CE} = V_{CES}$; $V_{GE} = 0$ V	$T_{VJ} = 25^{\circ}\text{C}$		0.3	mA
		$T_{VJ} = 125^{\circ}\text{C}$	0.6		mA
I_{GES}	$V_{CE} = 0$ V; $V_{GE} = \pm 20$ V			400	nA
C_{ies}	$V_{CE} = 25$ V; $V_{GE} = 0$ V; $f = 1$ MHz		4.4		nF
Q_{Gon}	$V_{CE} = 900$ V; $V_{GE} = 15$ V; $I_C = 30$ A		600		nC
$t_{d(on)}$ t_r $t_{d(off)}$ t_f E_{off} E_{on}	Inductive load, $T_{VJ} = 125^{\circ}\text{C}$ $V_{CE} = 900$ V; $I_C = 30$ A $V_{GE} = \pm 15$ V; $R_G = 45$ Ω		190		ns
			45		ns
			970		ns
			340		ns
			7.5		mJ
			8.5		mJ
RBSOA	$I_C = I_{CM}$; $V_{GE} = 15$ V $R_G = 27$ Ω ; $T_{VJ} = 125^{\circ}\text{C}$	$V_{CEK} \leq V_{CES} - L_S di/dt$			V
t_{SC} (SCSOA)	$V_{CE} = 900$ V; $V_{GE} = \pm 15$ V; $R_G = 45$ Ω $t_p \leq 10$ μs ; non-repetitive; $T_{VJ} = 125^{\circ}\text{C}$		10		μs
R_{thJC}				0.62	K/W

Brake Chopper D7			
Symbol	Conditions	Maximum Ratings	
V_{RRM}	$T_{VJ} = 25^{\circ}\text{C}$ to 150°C	1700	V
I_{F25}	$T_C = 25^{\circ}\text{C}$	30	A
I_{F80}	$T_C = 80^{\circ}\text{C}$	21	A

Symbol	Conditions	Characteristic Values			
		min.	typ.	max.	
V_F	$I_F = 30$ A;	$T_{VJ} = 25^{\circ}\text{C}$	2.5	3.3	V
		$T_{VJ} = 125^{\circ}\text{C}$	2.6		V
I_R	$V_R = V_{RRM}$;	$T_{VJ} = 25^{\circ}\text{C}$		0.05	mA
		$T_{VJ} = 125^{\circ}\text{C}$	0.2		mA
I_{RM} t_{rr}	$I_F = 30$ A; $di_F/dt = -700$ A/ μs ; $T_{VJ} = 125^{\circ}\text{C}$ $V_R = 900$ V		38		A
			670		ns
R_{thJC}	(per diode)			0.9	K/W

Temperature Sensor NTC

Symbol	Conditions	Characteristic Values			
		min.	typ.	max.	
R_{25}	$T = 25^{\circ}\text{C}$	4.75	5.0	5.25	k Ω
$B_{25/50}$			3375		K

Module

Symbol	Conditions	Maximum Ratings		
T_{VJ}	operating	-40...+125		$^{\circ}\text{C}$
T_{JM}		+150		$^{\circ}\text{C}$
T_{stg}		-40...+125		$^{\circ}\text{C}$
V_{ISO}	$I_{ISOL} \leq 1 \text{ mA}; 50/60 \text{ Hz}; 1 \text{ min.}$		3400	V~
M_d	Mounting torque (M5)		3 - 6	Nm

Symbol	Conditions	Characteristic Values			
		min.	typ.	max.	
$R_{\text{therm-chip}}$	Resistance terminal to chip		7		m Ω
d_s	Creepage distance on surface	12.7			mm
d_A	Strike distance in air	9.6			mm
R_{thCH}	with heatsink compound		0.01		K/W
Weight			300		g

Dimensions in mm (1 mm = 0.0394")

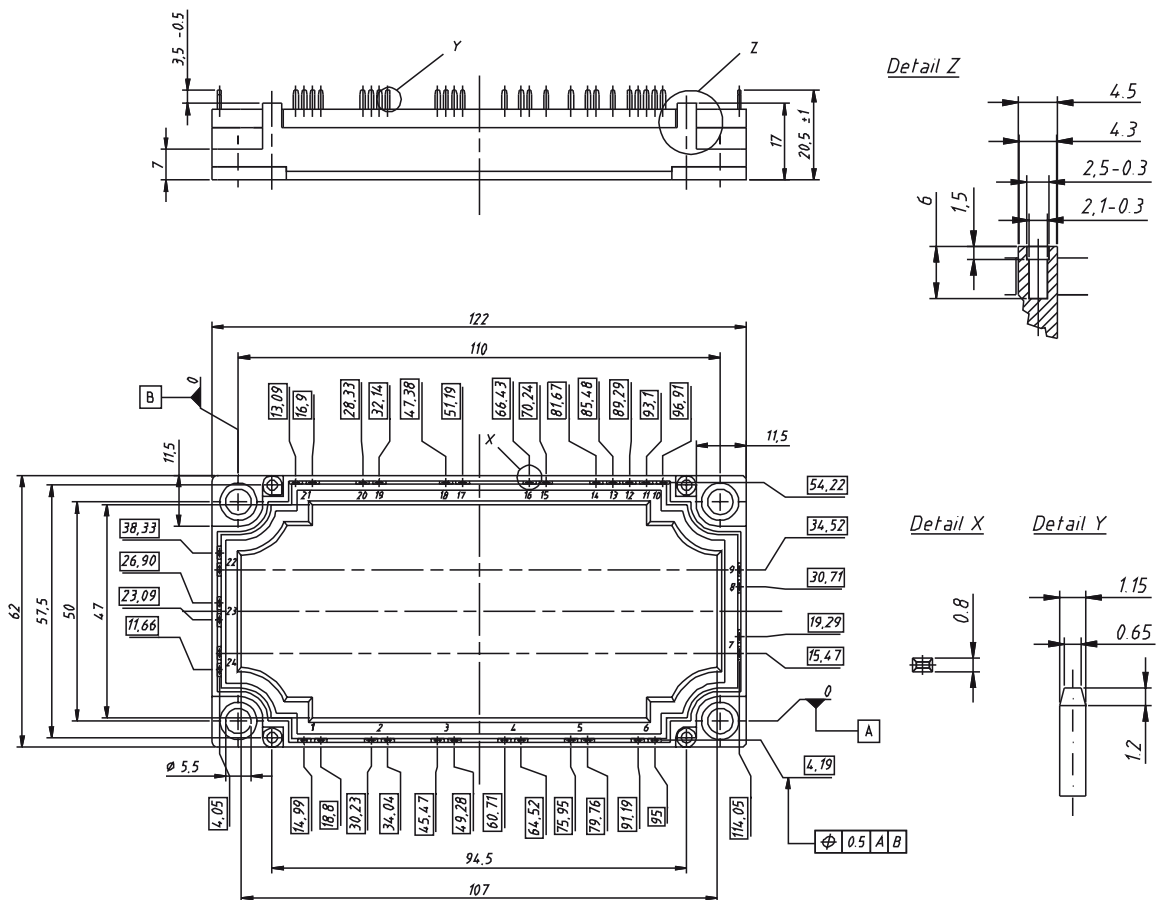

IXYS reserves the right to change limits, test conditions and dimensions.

20090826a

© 2009 IXYS All rights reserved

Input Rectifier Bridge D11 - D16

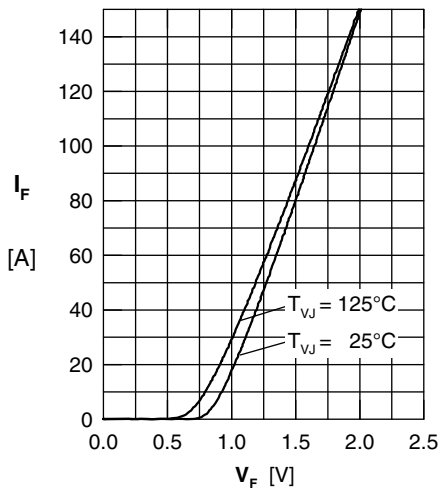

Fig. 1 Typ. forward current vs. voltage drop per diode

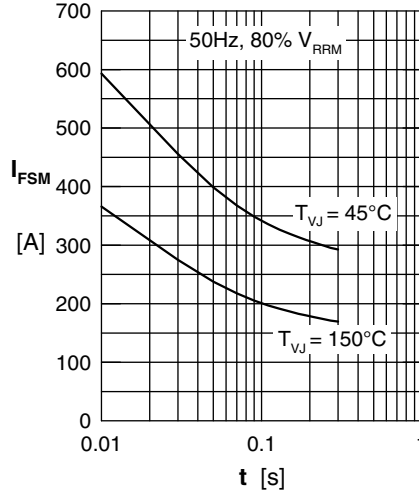

Fig. 2 Surge overload current

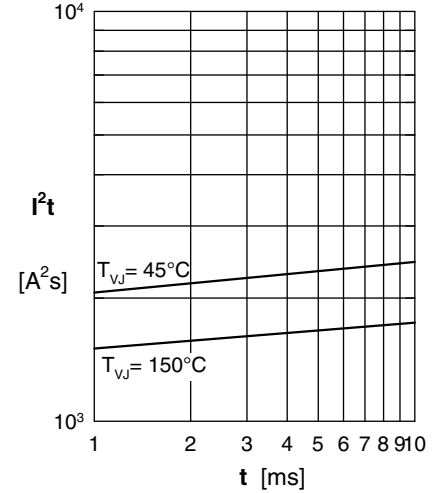

Fig. 3 I²t versus time per diode

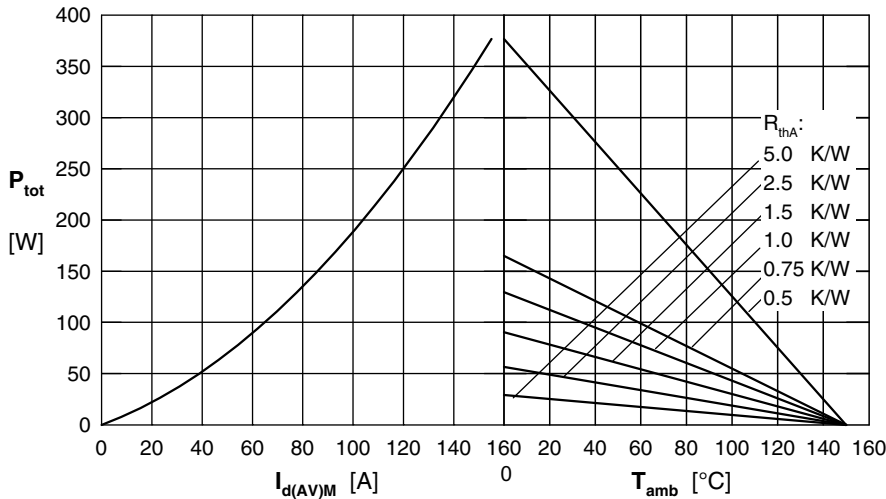

Fig. 4 Power dissipation vs. direct output current & amb. temperature, sin 180°

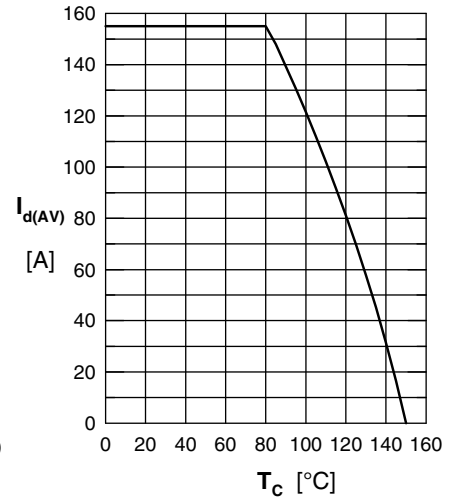

Fig. 5 Max. forward current vs. case temperature

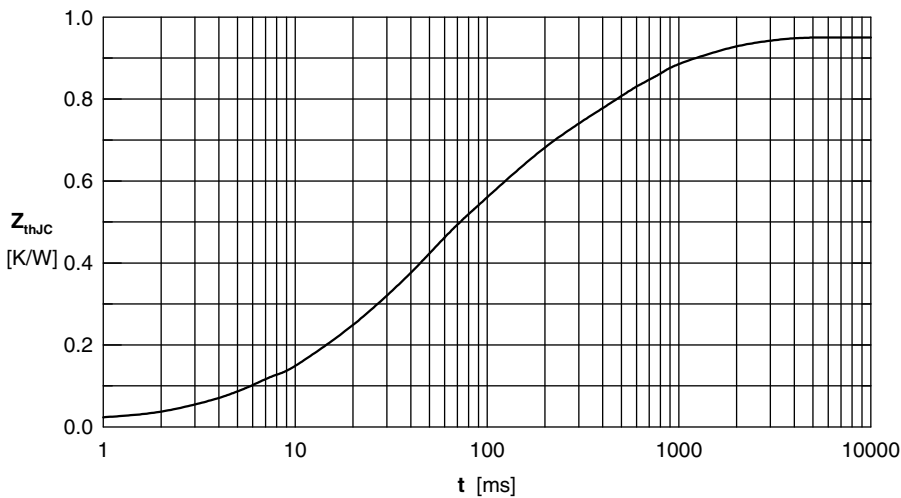
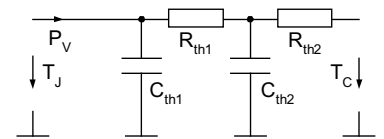

Fig. 6 Transient thermal impedance junction to case



	R _i	τ _i
1	0.049	0.0085
2	0.012	0.0017
3	0.465	0.045
4	0.105	0.85
5	0.32	0.33

Output Inverter T1 - T6 / D1 - D6

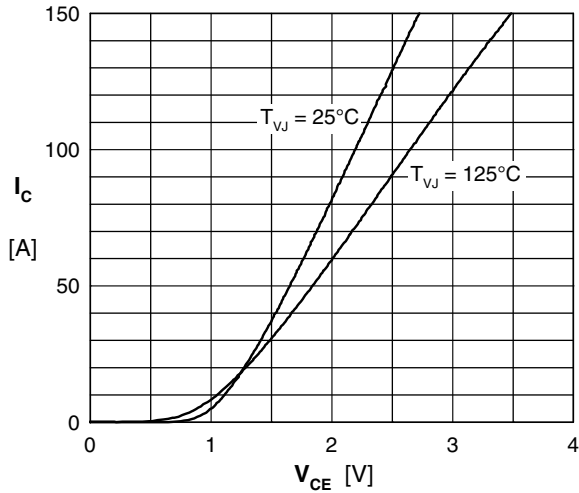

Fig. 7 Typical output characteristic

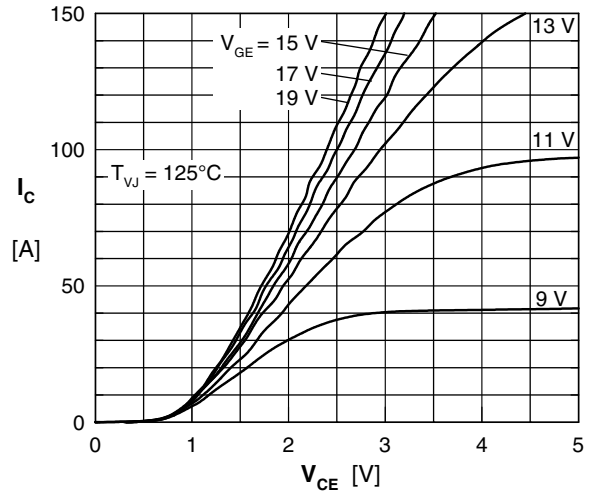

Fig. 8 Typical output characteristic

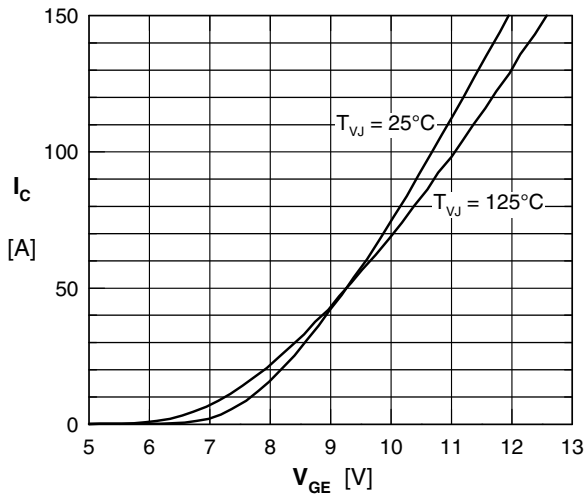

Fig. 9 Typical transfer characteristic

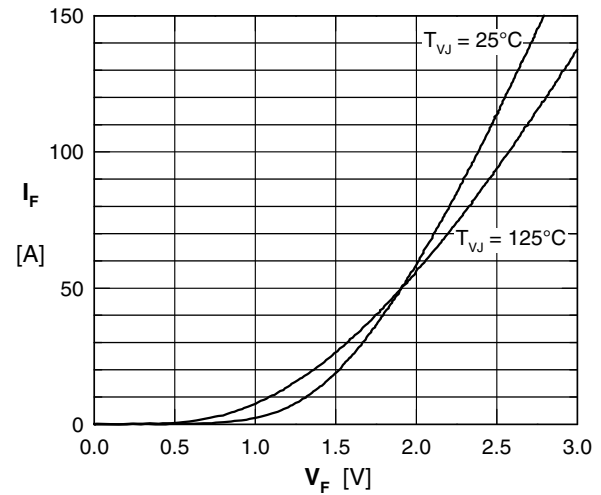

Fig. 10 Typical forward characteristic of free wheeling diode

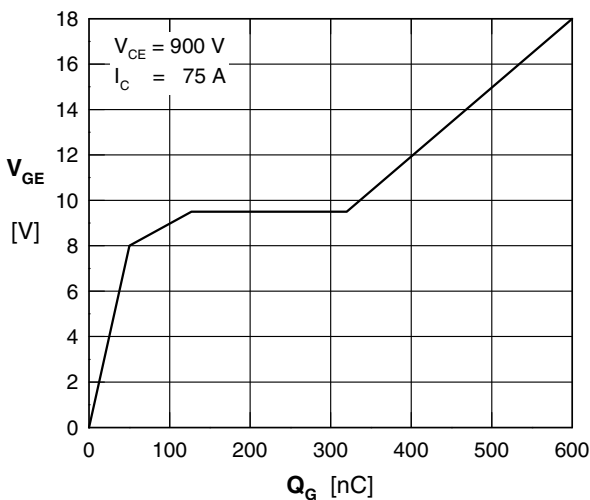

Fig. 11 Typical turn on gate charge

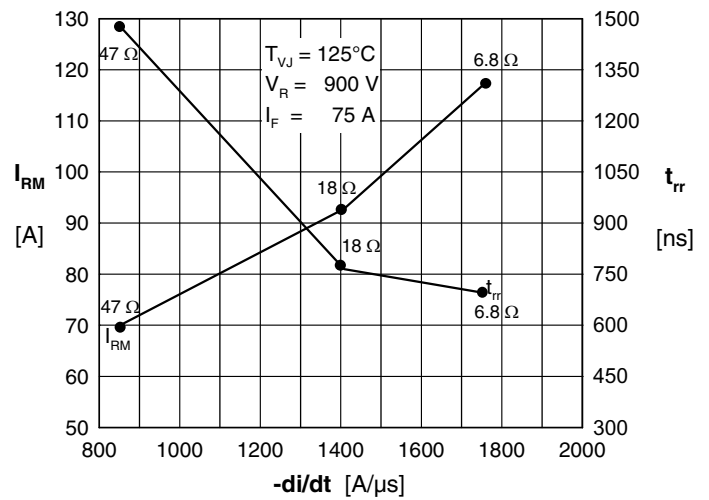

Fig. 12 Typ. turn-off characteristics of free wheeling diode

Output Inverter T1 - T6 / D1 - D6

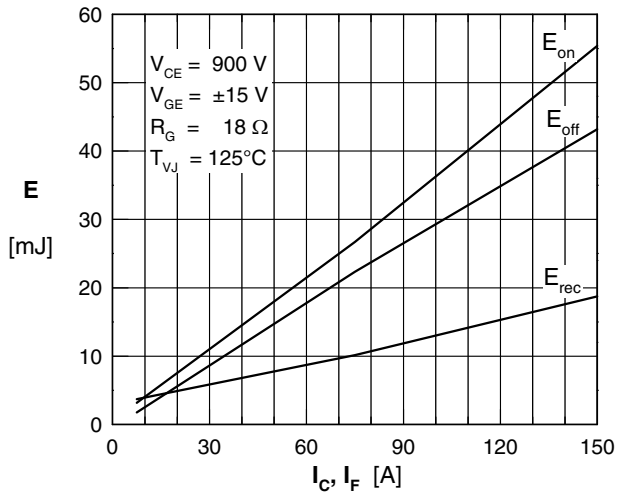

Fig. 13 Typ. turn on energy & switching times versus collector current

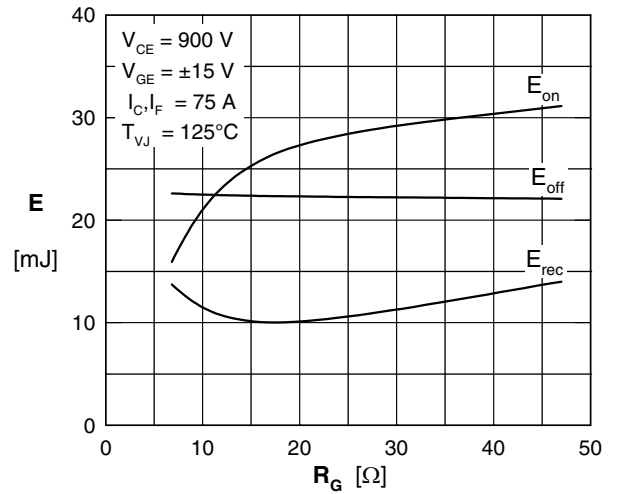

Fig. 14 Typ. turn off energy and switching times versus collector current

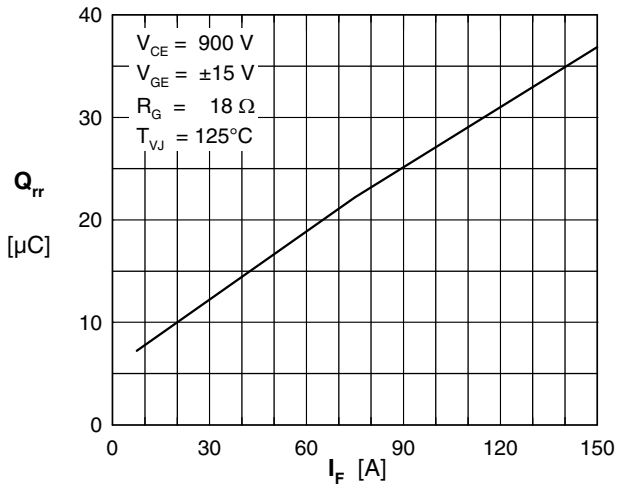

Fig. 15 Typical turn-off characteristics of free wheeling diode

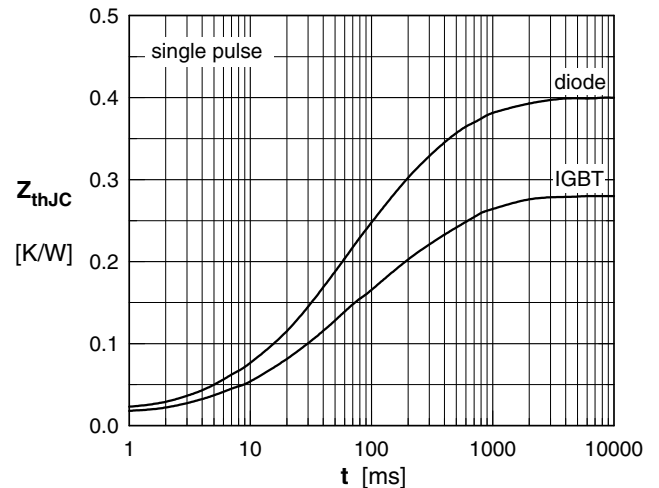

Fig. 16 Transient thermal impedance junction to case

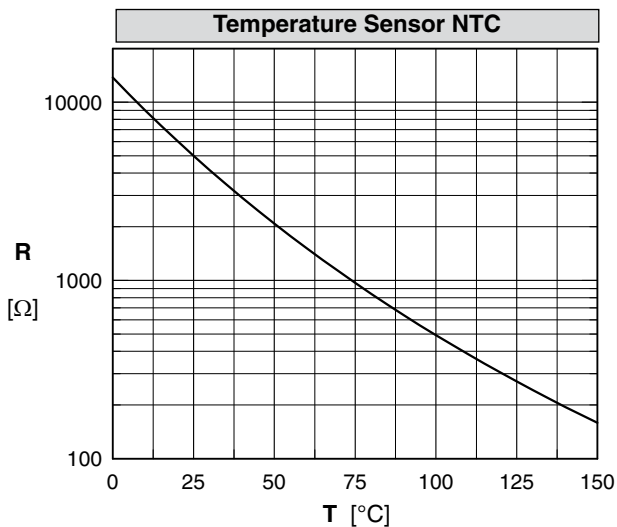
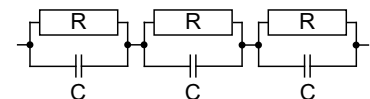

Fig. 17 Typ. transient thermal impedance

	IGBT		Diode	
	R _i	τ _i	R _i	τ _i
1	0.0175	0.0015	0.0265	0.0020
2	0.0860	0.0276	0.1443	0.0318
3	0.0920	0.1311	0.1655	0.1618
4	0.0832	0.6329	0.0636	0.8218



Brake Chopper T7 / D7

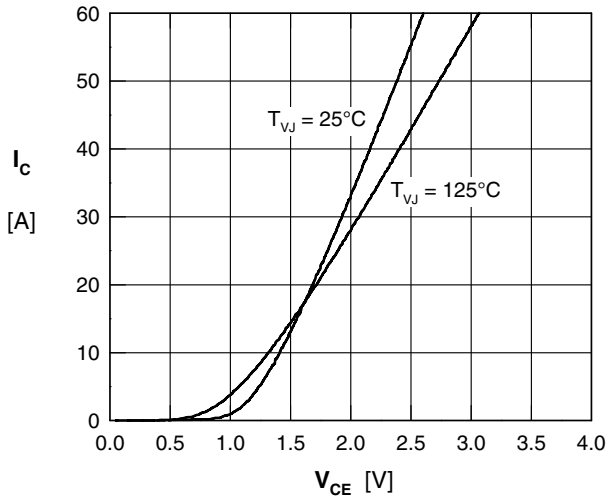

Fig. 18 Typical output characteristic

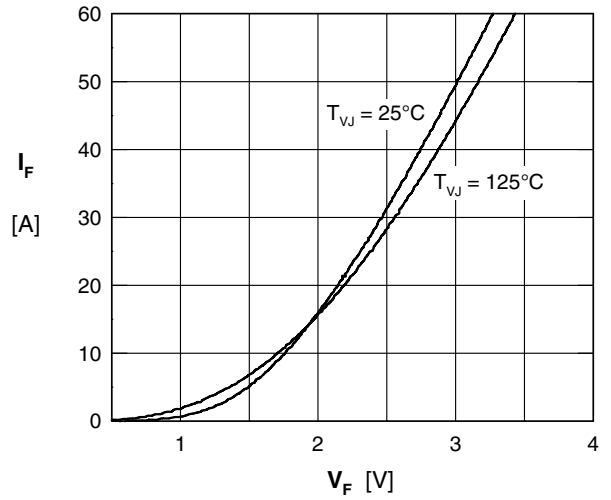

Fig. 19 Typ. forward characteristics of brake diode

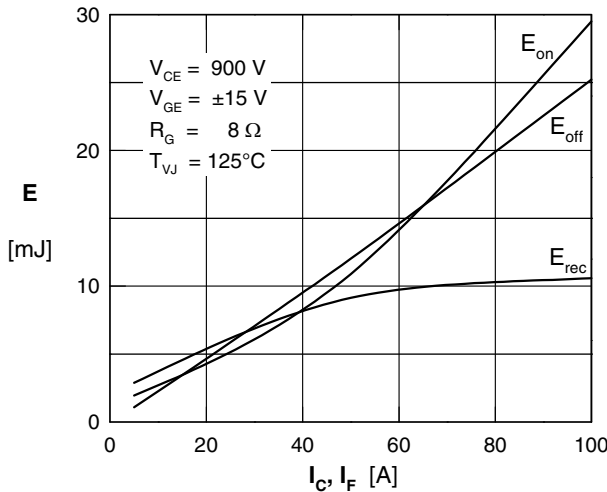

Fig. 20 Typ. turn on energy & switching times versus collector current

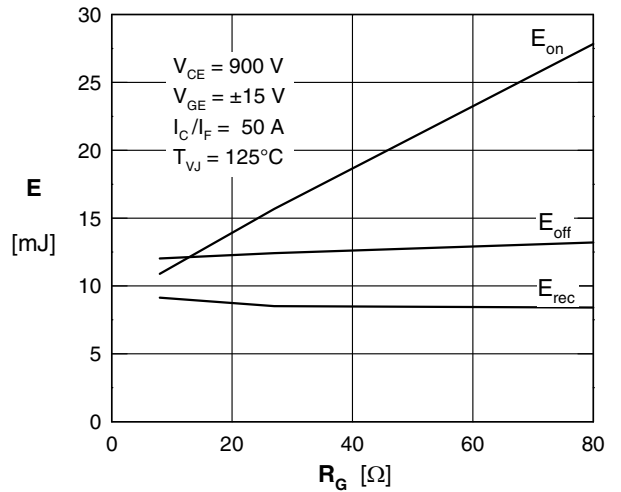

Fig. 21 Typ. turn off energy and switching times versus collector current

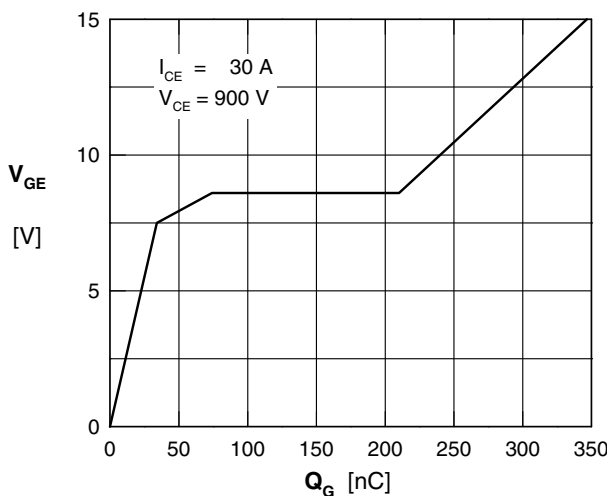

Fig. 22 Typ. turn on gate charge

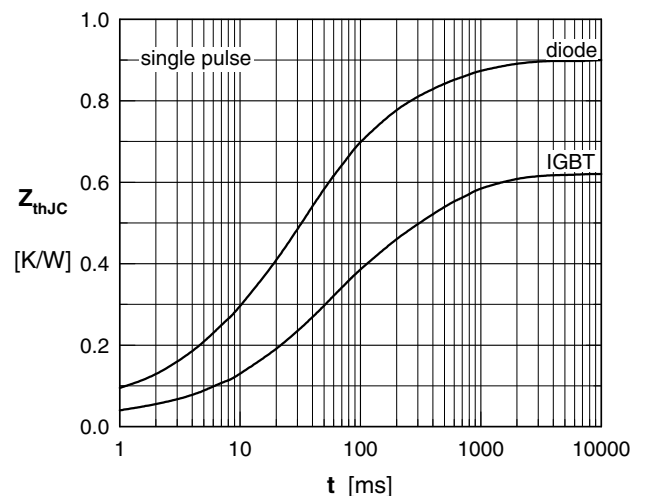

Fig. 23 Typ. NTC resistance versus temperature