

Converter - Brake - Inverter Module (CBI3) with Trench IGBT technology

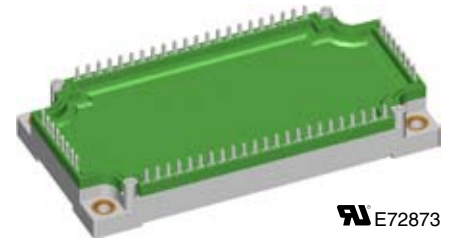
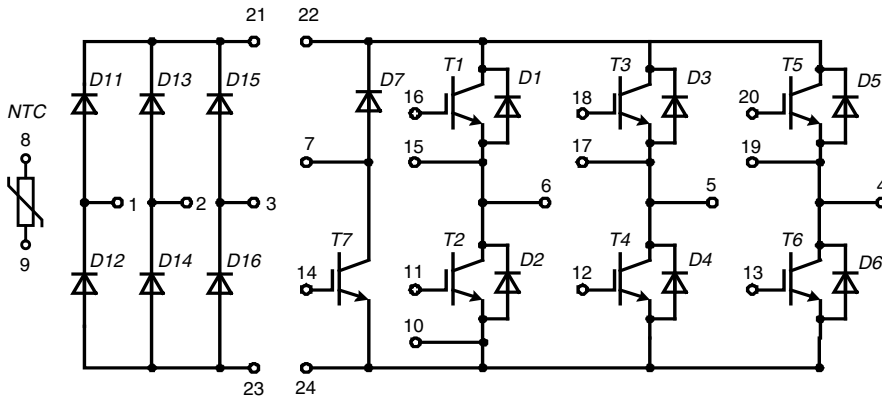

E72873

Three Phase Rectifier	Brake Chopper	Three Phase Inverter
$V_{RRM} = 2200 \text{ V}$	$V_{CES} = 1700 \text{ V}$	$V_{CES} = 1700 \text{ V}$
$I_{FAVM} = 60 \text{ A}$	$I_{C25} = 48 \text{ A}$	$I_{C25} = 74 \text{ A}$
$I_{FSM} = 550 \text{ A}$	$V_{CE(sat)} = 2.1 \text{ V}$	$V_{CE(sat)} = 2.0 \text{ V}$

Input Rectifier Bridge D11 - D16			
Symbol	Conditions	Maximum Ratings	
V_{RRM}		2200	V
I_{FAV}	$T_C = 80^\circ\text{C}$; sine 180°	40	A
I_{DAVM}	$T_C = 80^\circ\text{C}$; rectangular; $d = 1/3$; bridge	130	A
I_{FSM}	$T_C = 25^\circ\text{C}$; $t = 10 \text{ ms}$; sine 50 Hz	550	A
P_{tot}	$T_C = 25^\circ\text{C}$	110	W

Symbol	Conditions	Characteristic Values				
		min.	typ.	max.		
$(T_{VJ} = 25^\circ\text{C}, \text{ unless otherwise specified})$						
V_F	$I_F = 50 \text{ A}$;	$T_{VJ} = 25^\circ\text{C}$		1.25	1.5	V
		$T_{VJ} = 125^\circ\text{C}$		1.25		V
I_R	$V_R = V_{RRM}$;	$T_{VJ} = 25^\circ\text{C}$		0.8	0.05	mA
		$T_{VJ} = 125^\circ\text{C}$				mA
R_{thJC}	(per diode)				1.1	K/W

Application: AC motor drives with

- Input from single or three phase grid
- Three phase synchronous or asynchronous motor
- Electric braking operation

Features

- High level of integration - only one power semiconductor module required for the whole drive
- IGBT technology with low saturation voltage, low switching losses and tail current, high RBSOA and short circuit ruggedness
- Epitaxial free wheeling diodes with Hiperfast and soft reverse recovery
- Industry standard package with insulated copper base plate and soldering pins for PCB mounting
- Temperature sense included

Output Inverter T1 - T6			
Symbol	Conditions	Maximum Ratings	
V_{CES}	$T_{VJ} = 25^{\circ}\text{C}$ to 150°C	1700	V
V_{GES}	Continuous	± 20	V
I_{C25}	$T_C = 25^{\circ}\text{C}$	74	A
I_{C80}	$T_C = 80^{\circ}\text{C}$	53	A
I_{CM}	$T_C = 80^{\circ}\text{C}$; $t_p = 1$ ms	100	A
P_{tot}	$T_C = 25^{\circ}\text{C}$	290	W

Symbol	Conditions	Characteristic Values				
		(T _{VJ} = 25°C, unless otherwise specified)				
		min.	typ.	max.		
$V_{CE(sat)}$	$I_C = 50$ A; $V_{GE} = 15$ V	$T_{VJ} = 25^{\circ}\text{C}$		2.0	2.4	V
		$T_{VJ} = 125^{\circ}\text{C}$		2.4		V
$V_{GE(th)}$	$I_C = 2$ mA; $V_{GE} = V_{CE}$	5		6.5	V	
I_{CES}	$V_{CE} = V_{CES}$; $V_{GE} = 0$ V			0.4	mA	
			1.0		mA	
I_{GES}	$V_{CE} = 0$ V; $V_{GE} = \pm 20$ V			400	nA	
C_{ies}	$V_{CE} = 25$ V; $V_{GE} = 0$ V; $f = 1$ MHz		4.4		nF	
Q_{Gon}	$V_{CE} = 900$ V; $V_{GE} = 15$ V; $I_C = 75$ A		600		nC	
$t_{d(on)}$ t_r $t_{d(off)}$ t_f E_{on} E_{off}	Inductive load, $T_{VJ} = 125^{\circ}\text{C}$ $V_{CE} = 900$ V; $I_C = 50$ A $V_{GE} = \pm 15$ V; $R_G = 8$ Ω		250		ns	
			50		ns	
			500		ns	
			480		ns	
			11		mJ	
			12		mJ	
RBSOA	$I_C = I_{CM}$; $V_{GE} = 15$ V $R_G = 27$ Ω ; $T_{VJ} = 125^{\circ}\text{C}$	$V_{CEK} \leq V_{CES} - L_S di/dt$			V	
t_{SC} (SCSOA)	$V_{CE} = 1000$ V; $V_{GE} = \pm 15$ V; $R_G = 27$ Ω $t_p \leq 10$ μs ; non-repetitive; $T_{VJ} = 125^{\circ}\text{C}$		10		μs	
R_{thJC}			0.43		K/W	

Output Inverter D1 - D6			
Symbol	Conditions	Maximum Ratings	
I_{F25}	$T_C = 25^{\circ}\text{C}$	56	A
I_{F80}	$T_C = 80^{\circ}\text{C}$	39	A

Symbol	Conditions	Characteristic Values				
		min.	typ.	max.		
V_F	$I_F = 50$ A;	$T_{VJ} = 25^{\circ}\text{C}$		2.0	2.4	V
		$T_{VJ} = 125^{\circ}\text{C}$		2.0		V
I_{RM}	$I_F = 50$ A; $di_F/dt = -1200$ A/ μs ; $T_{VJ} = 125^{\circ}\text{C}$; $V_R = 900$ V; $V_{GE} = 0$ V		80		A	
Q_{rr}		20		μC		
t_{rr}		650		ns		
E_{rec}		9		mJ		
R_{thJC}	(per diode)			0.65	K/W	

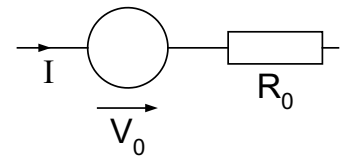
Equivalent Circuits for Simulation
Conduction

IGBT (typ. at $V_{GE} = 15$ V; $T_J = 125^{\circ}\text{C}$)
T1-T6

$V_0 = 1.0$ V; $R_0 = 25$ m Ω

T7

$V_0 = 1.0$ V; $R_0 = 28$ m Ω

Diode (typ. at $T_J = 125^{\circ}\text{C}$)
D1-D6

$V_0 = 1.35$ V; $R_0 = 15$ m Ω

D7

$V_0 = 1.65$ V; $R_0 = 37$ m Ω

D11-D16

$V_0 = 0.83$ V; $R_0 = 4.1$ m Ω

Brake Chopper T7							
Symbol	Conditions	Maximum Ratings					
V_{CES}	$T_{VJ} = 25^{\circ}\text{C}$ to 150°C	1700	V				
V_{GES}	Continuous	± 20	V				
I_{C25}	$T_C = 25^{\circ}\text{C}$	48	A				
I_{C80}	$T_C = 80^{\circ}\text{C}$	34	A				
I_{CM}	$T_C = 80^{\circ}\text{C}; t_p = 1 \text{ ms}$	60	A				
P_{tot}	$T_C = 25^{\circ}\text{C}$	200	W				
Symbol	Conditions	Characteristic Values					
($T_{VJ} = 25^{\circ}\text{C}$, unless otherwise specified)							
		min.	typ.	max.			
$V_{CE(sat)}$	$I_C = 30 \text{ A}; V_{GE} = 15 \text{ V}$		1.9	2.2	V		
			2.1		V		
$V_{GE(th)}$	$I_C = 2 \text{ mA}; V_{GE} = V_{CE}$	5		6.5	V		
I_{CES}	$V_{CE} = V_{CES}; V_{GE} = 0 \text{ V}$		0.6	0.3	mA		
					mA		
I_{GES}	$V_{CE} = 0 \text{ V}; V_{GE} = \pm 20 \text{ V}$			400	nA		
C_{iss}	$V_{CE} = 25 \text{ V}; V_{GE} = 0 \text{ V}; f = 1 \text{ MHz}$		4.4		nF		
Q_{Gon}	$V_{CE} = 900 \text{ V}; V_{GE} = 15 \text{ V}; I_C = 30 \text{ A}$		600		nC		
$t_{d(on)}$	Inductive load, $T_{VJ} = 125^{\circ}\text{C}$ $V_{CE} = 900 \text{ V}; I_C = 30 \text{ A}$ $V_{GE} = \pm 15 \text{ V}; R_G = 27 \Omega$		165		ns		
t_r			40		ns		
$t_{d(off)}$			700		ns		
t_f			400		ns		
E_{off}				7		mJ	
E_{on}				6		mJ	
RBSOA	$I_C = I_{CM}; V_{GE} = 15 \text{ V}$ $R_G = 27 \Omega; T_{VJ} = 125^{\circ}\text{C}$	$V_{CEK} \leq V_{CES} - L_S di/dt$			V		
t_{SC}	$V_{CE} = 900 \text{ V}; V_{GE} = \pm 15 \text{ V}; R_G = 45 \Omega$		10		μs		
(SCSOA)	$t_p \leq 10 \mu\text{s};$ non-repetitive; $T_{VJ} = 125^{\circ}\text{C}$						
R_{thJC}				0.62	K/W		

Brake Chopper D7						
Symbol	Conditions	Maximum Ratings				
V_{RRM}	$T_{VJ} = 25^{\circ}\text{C}$ to 150°C	1700	V			
I_{F25}	$T_C = 25^{\circ}\text{C}$	30	A			
I_{F80}	$T_C = 80^{\circ}\text{C}$	21	A			
Symbol	Conditions	Characteristic Values				
		min.	typ.	max.		
V_F	$I_F = 30 \text{ A};$		2.5	3.3	V	
	$T_{VJ} = 25^{\circ}\text{C}$		2.6		V	
I_R	$V_R = V_{RRM};$		0.2	0.05	mA	
	$T_{VJ} = 125^{\circ}\text{C}$				mA	
I_{RM}	$I_F = 30 \text{ A}; di_F/dt = -800 \text{ A}/\mu\text{s}; T_{VJ} = 125^{\circ}\text{C}$		35		A	
t_{rr}		$V_R = 900 \text{ V}$		700		ns
R_{thJC}	(per diode)			0.9	K/W	

Temperature Sensor NTC

Symbol	Conditions	Characteristic Values			
		min.	typ.	max.	
R_{25}	$T = 25^{\circ}\text{C}$	4.75	5.0	5.25	k Ω
$B_{25/50}$			3375		K

Module

Symbol	Conditions	Maximum Ratings	
T_{VJ}	operating	-40...+125	$^{\circ}\text{C}$
T_{JM}		+150	$^{\circ}\text{C}$
T_{stg}		-40...+125	$^{\circ}\text{C}$
V_{ISO}	$I_{ISOL} \leq 1 \text{ mA}; 50/60 \text{ Hz}; 1 \text{ min.}$	3400	V~
M_d	Mounting torque (M5)	3 - 6	Nm

Symbol	Conditions	Characteristic Values		
		min.	typ.	max.
$R_{therm-chip}$	Resistance terminal to chip		7	m Ω
d_s	Creepage distance on surface	12.7		mm
d_A	Strike distance in air	9.6		mm
R_{thCH}	with heatsink compound		0.02	K/W
Weight			300	g

Dimensions in mm (1 mm = 0.0394")

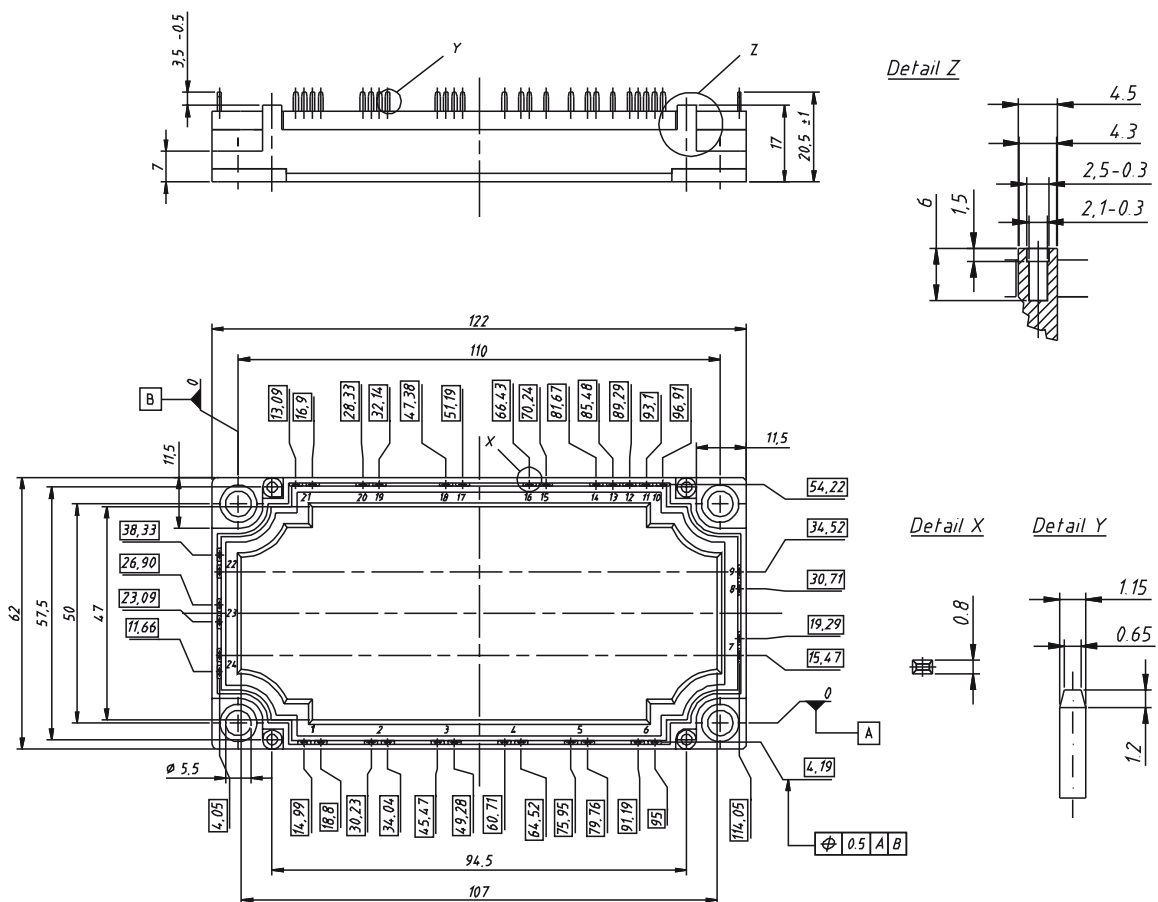

IXYS reserves the right to change limits, test conditions and dimensions.

20090826a

© 2009 IXYS All rights reserved

Input Rectifier Bridge D11 - D16

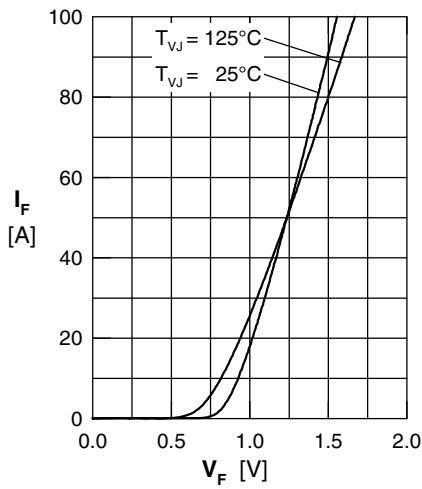

Fig. 1 Typ. forward current vs. voltage drop per diode

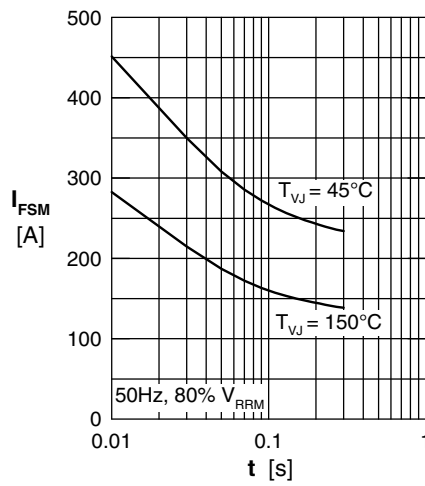

Fig. 2 Surge overload current

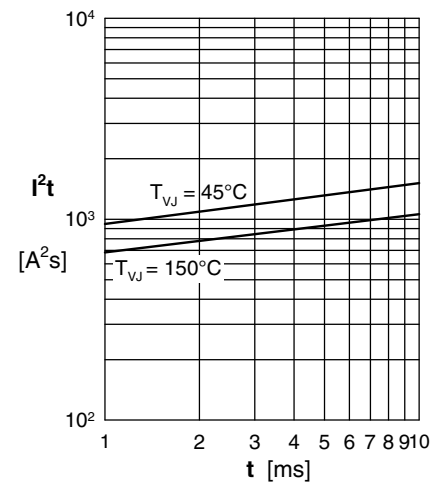

Fig. 3 I^2t versus time per diode

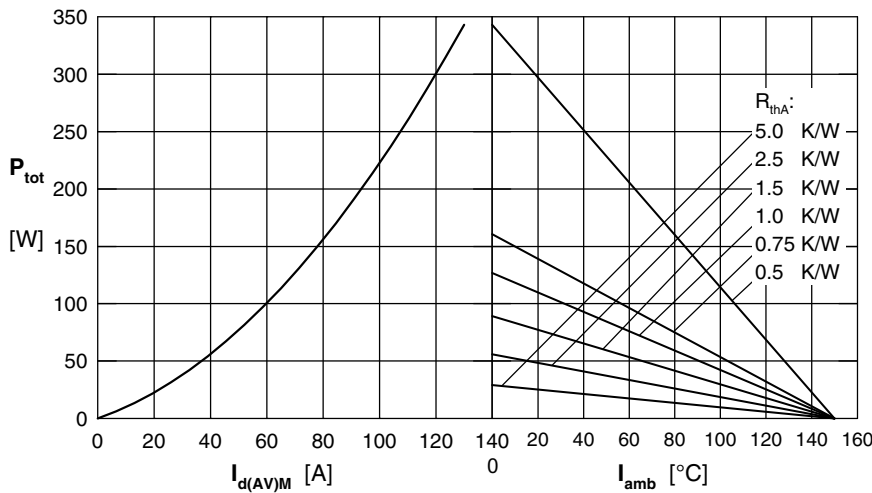

Fig. 4 Power dissipation versus direct output current & ambient temperature, sin 180°

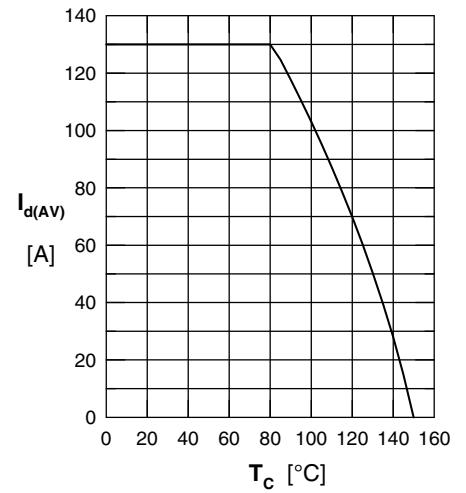

Fig. 5 Max. forward current vs. case temperature

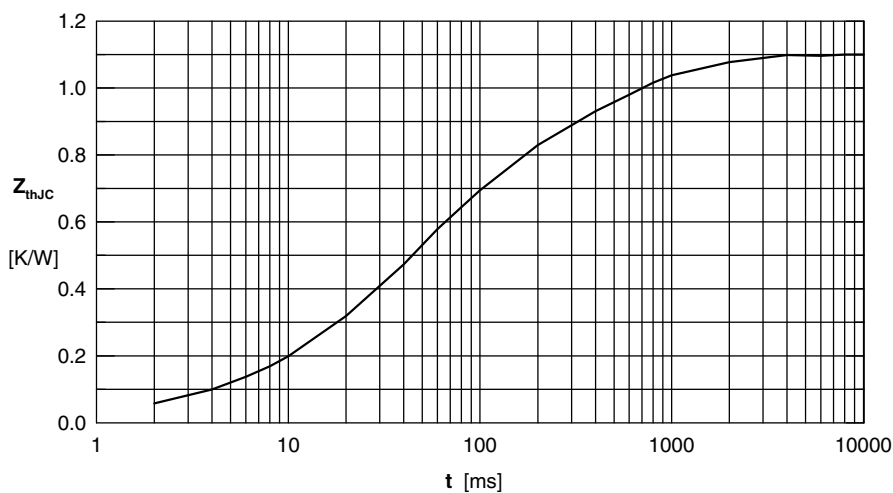
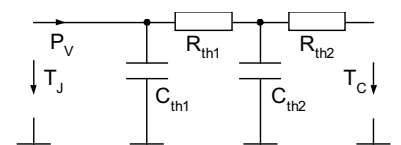

Fig. 6 Transient thermal impedance junction to case



	R_i	τ_i
1	0.06	0.0085
2	0.024	0.001
3	0.586	0.045
4	0.114	0.85
5	0.317	0.35

Output Inverter T1 - T6 / D1 - D6

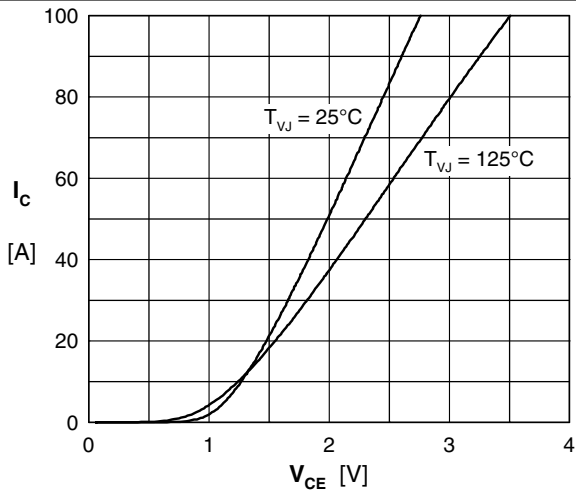

Fig. 7 Typical output characteristic

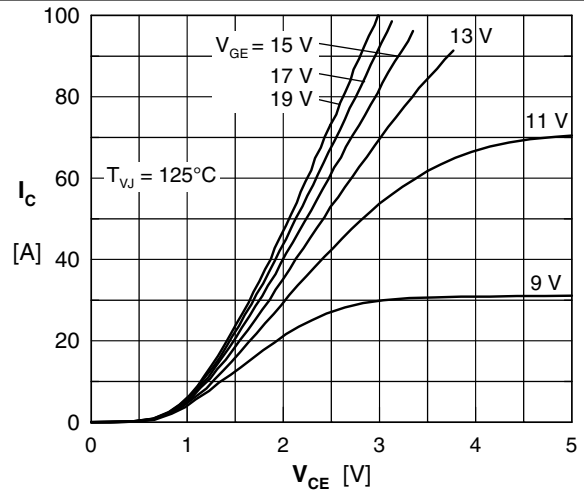

Fig. 8 Typical output characteristic

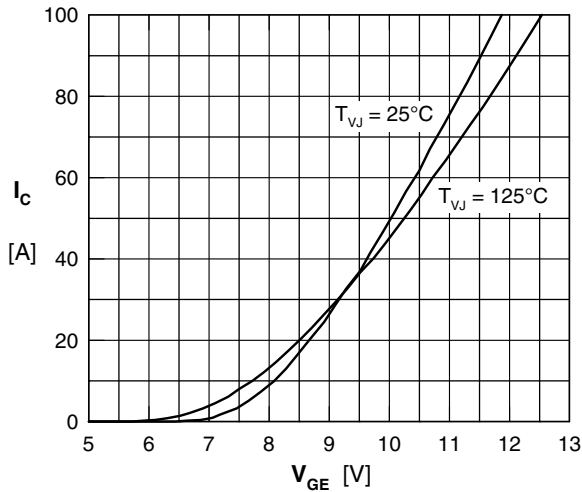

Fig. 9 Typical transfer characteristic

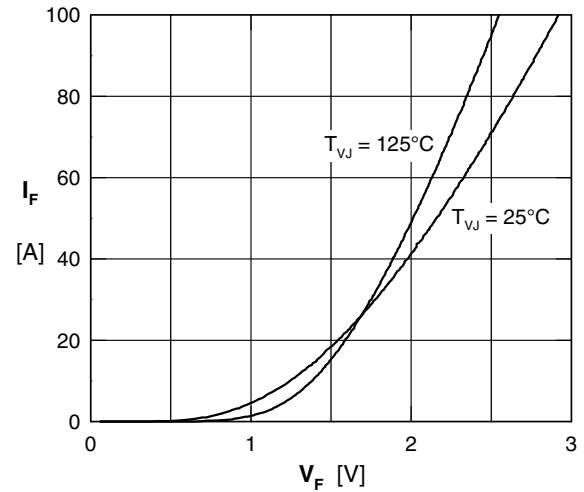

Fig. 10 Typical forward characteristic of free wheeling diode

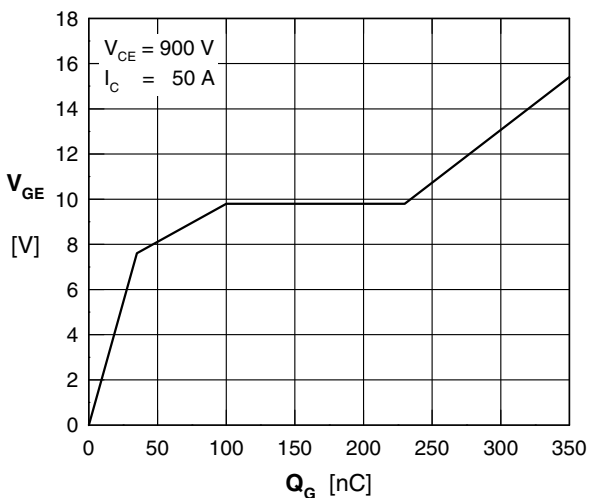

Fig. 11 Typical turn on gate charge

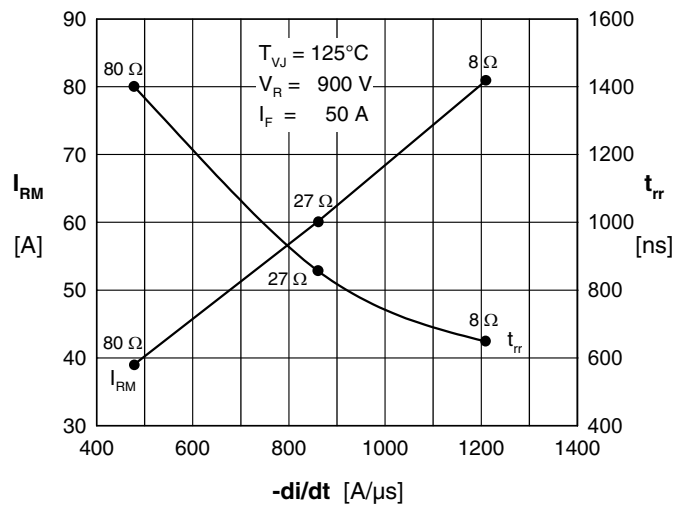

Fig. 12 Typ. turn-off characteristics of free wheeling diode

IXYS reserves the right to change limits, test conditions and dimensions.

20090826a

Output Inverter T1 - T6 / D1 - D6

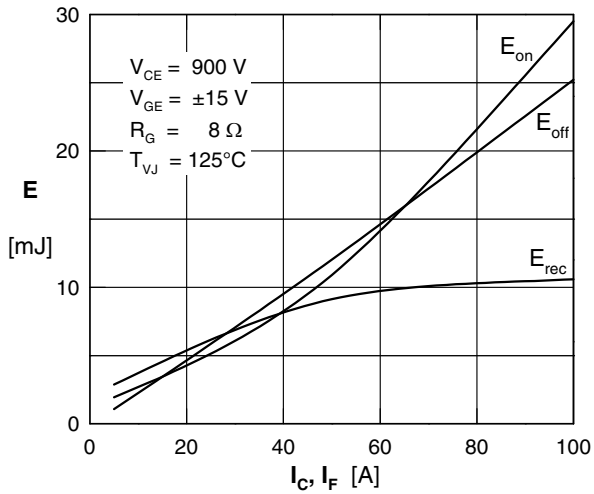

Fig. 13 Typ. turn on energy & switching times versus collector current

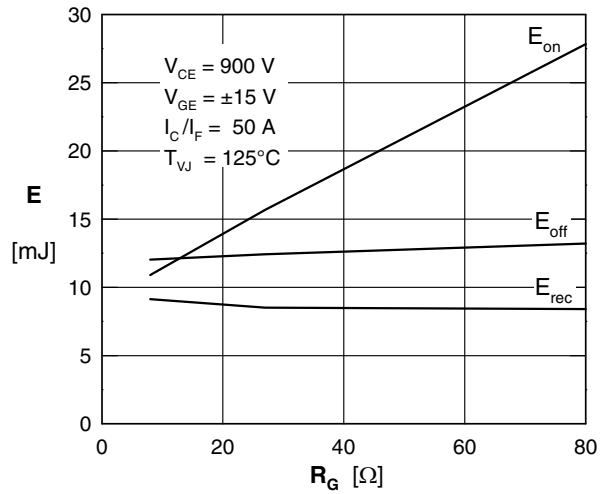

Fig. 14 Typ. turn off energy and switching times versus collector current

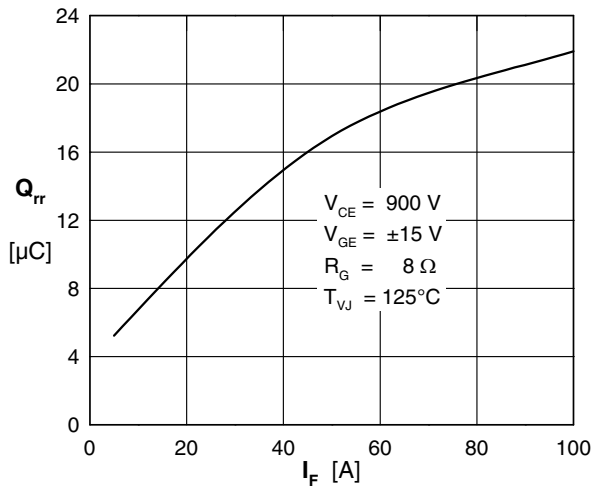

Fig. 15 Typical turn-off characteristics of free wheeling diode

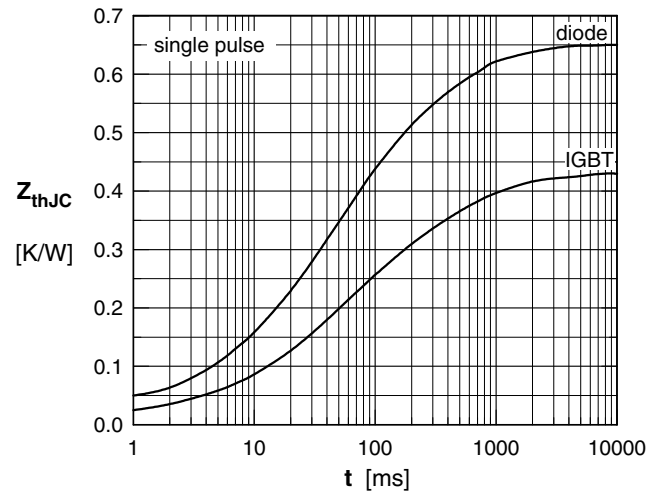

Fig. 16 Transient thermal impedance junction to case

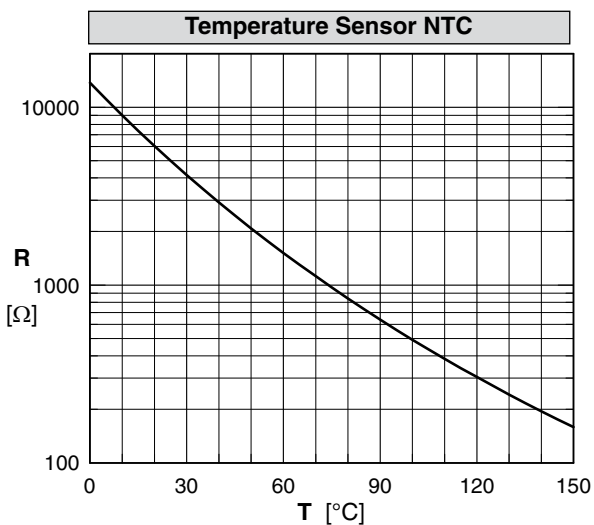
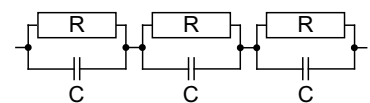

Fig. 17 Typ. NTC resistance vs. temperature

	IGBT		Diode	
	R_i	τ_i	R_i	τ_i
1	0.0326	0.0014	0.1941	0.0206
2	0.1311	0.0258	0.0542	0.0016
3	0.1492	0.1099	0.2549	0.0930
4	0.1169	0.6361	0.1461	0.5958



Brake Chopper T7 / D7

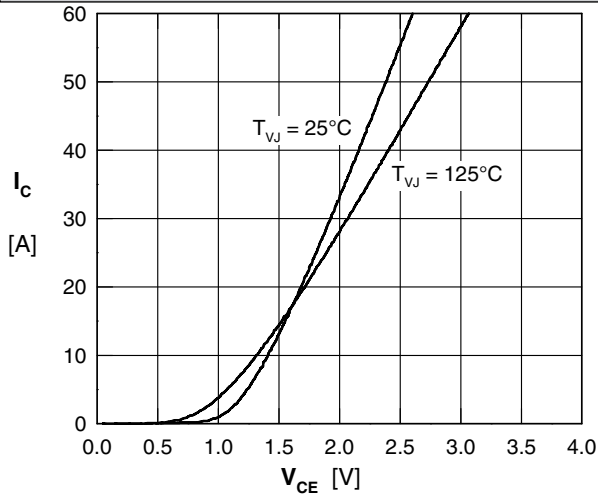

Fig. 18 Typical output characteristic

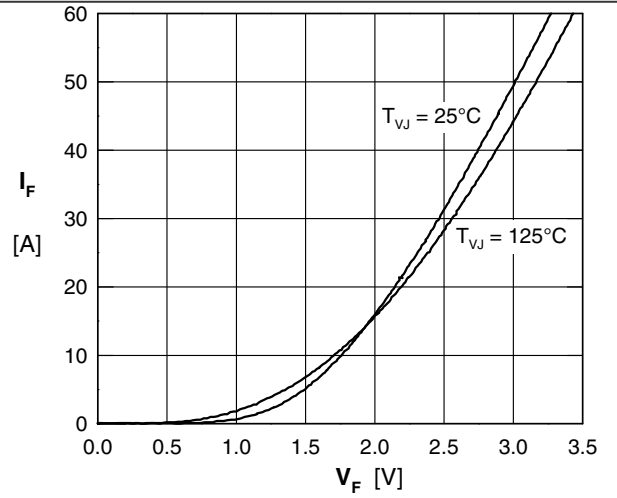

Fig. 19 Typ. forward characteristics of brake diode

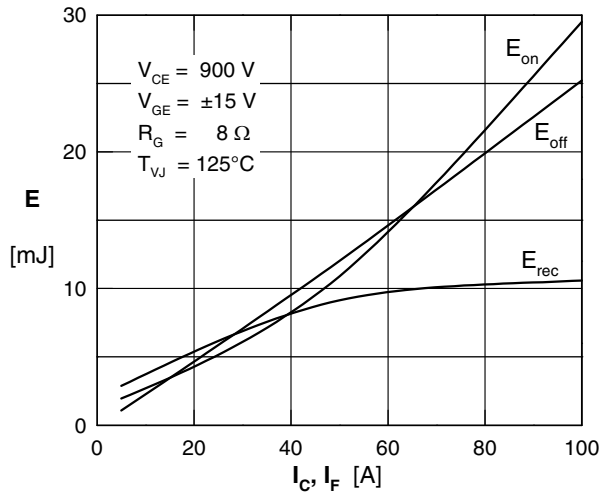

Fig. 20 Typ. turn on energy & switching times versus collector current

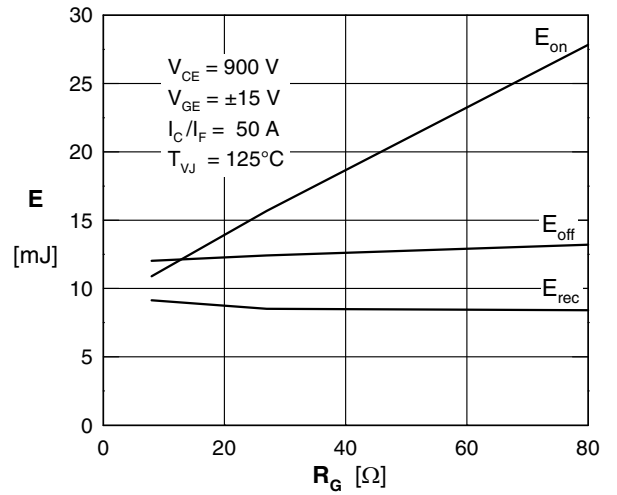

Fig. 21 Typ. turn off energy and switching times versus collector current

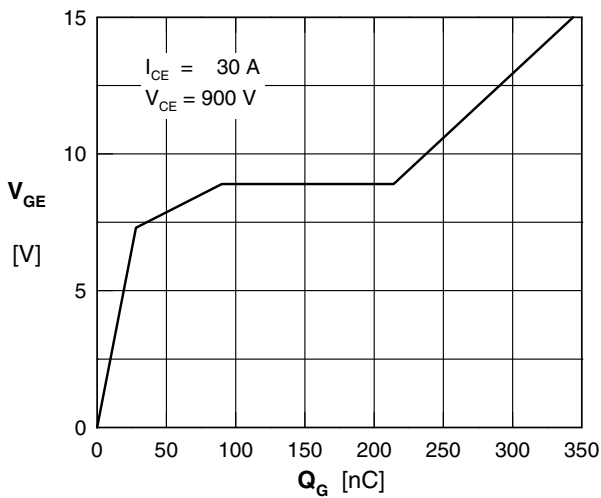

Fig. 22 Typ. turn on gate charge

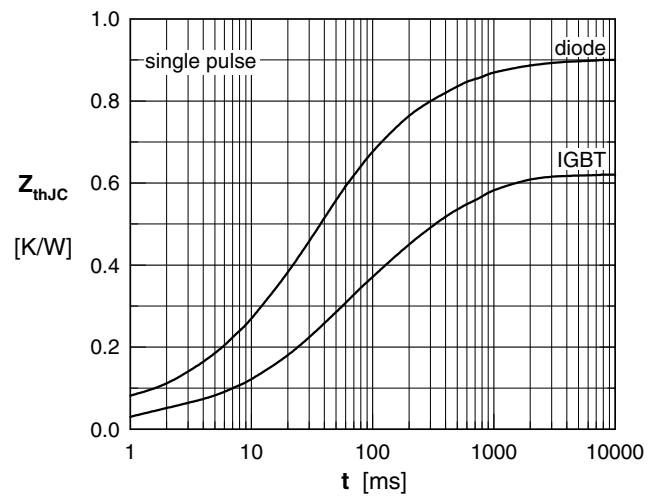

Fig. 23 Transient thermal impedance junction to case

IXYS reserves the right to change limits, test conditions and dimensions.

20090826a