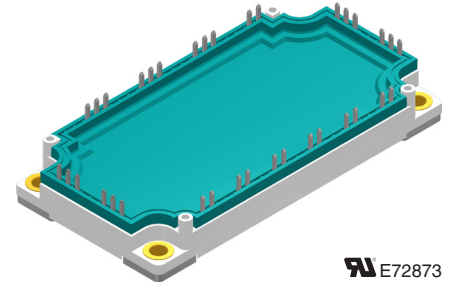


X2PT IGBT Module

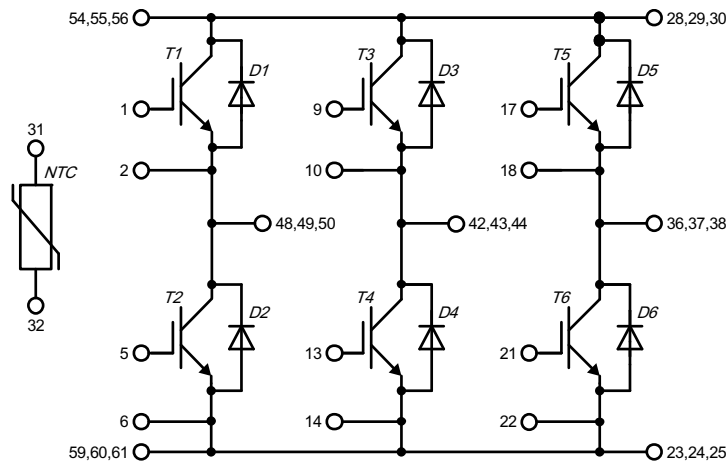
$V_{CES} = 1200\text{ V}$
 $I_{C25} = 260\text{ A}$
 $V_{CE(sat)} = 1.7\text{ V}$

6-Pack + NTC

Part number
 MIXG180W1200TEH



 E72873



Features / Advantages:

- X2PT - 2nd generation Xtreme light Punch Through
- $T_{VJM} = 175^{\circ}\text{C}$
- Easy paralleling due to the positive temperature coefficient of the on-state voltage
- Rugged X2PT design results in:
 - short circuit rated for 10 μsec .
 - very low gate charge
 - low EMI
 - square RBSOA @ 2x I_c
- Low $V_{CE(sat)}$ and low thermal resistance
- SONIC™ diode
 - fast and soft reverse recovery
 - low operating forward voltage

Applications:

- AC motor drives
- Solar inverter
- Medical equipment
- Uninterruptible power supply
- Air-conditioning systems
- Welding equipment
- Switched-mode and resonant-mode power supplies
- Inductive heating, cookers
- Pumps, Fans

Package: E3-Pack

- Isolation Voltage: 4300 V~
- Industry standard outline
- RoHS compliant
- Base plate: Copper internally DCB isolated
- Advanced power cycling
- Solder pins

Option:

- Phase Change Material printed on base plate

Disclaimer Notice

Information furnished is believed to be accurate and reliable. However, users should independently evaluate the suitability of and test each product selected for their own applications. Littelfuse products are not designed for, and may not be used in, all applications. Read complete Disclaimer Notice Disclaimer Notice at www.littelfuse.com/disclaimer-electronics.



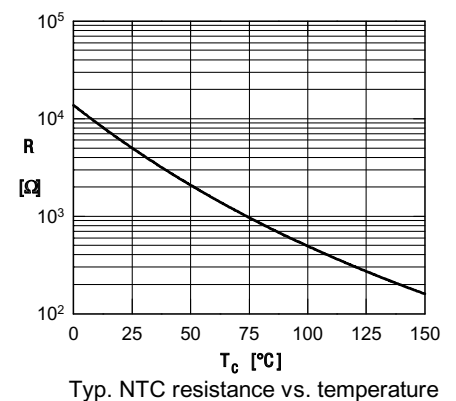
Inverter IGBT T1 - T6				Ratings			
Symbol	Definitions	Conditions	min.	typ.	max.		
V_{CES}	collector emitter voltage	$T_{VJ} = 25^{\circ}\text{C}$			1200	V	
V_{GES}	max. DC gate voltage		-20		+20	V	
V_{GEM}	max. transient gate emitter voltage		-30		+30	V	
I_{C25}	collector current	$T_C = 25^{\circ}\text{C}$			260	A	
I_{C80}		$T_C = 80^{\circ}\text{C}$			195	A	
I_{C100}		$T_C = 100^{\circ}\text{C}$			165	A	
P_{tot}	total power dissipation	$T_C = 25^{\circ}\text{C}$			830	W	
$V_{CE(sat)}$	collector emitter saturation voltage	$I_C = 150\text{ A}; V_{GE} = 15\text{ V}$		1.7 2	2	V V	
$V_{GE(th)}$	gate emitter threshold voltage	$I_C = 6\text{ mA}; V_{GE} = V_{GE}$	5.5		7	V	
I_{CES}	collector emitter leakage current	$V_{CE} = V_{CES}; V_{GE} = 0\text{ V}$		3	0.4	mA mA	
I_{GES}	gate emitter leakage current	$V_{GE} = \pm 20\text{ V}$			500	nA	
R_G	internal gate resistance			2.5		Ω	
C_{iss}	input capacitance	$V_{CE} = 100\text{ V}; V_{GS} = 0\text{ V}; f = 1\text{ MHz}$		8.5		nF	
C_{oss}	output capacitance					pF	
C_{rss}	reverse transfer (Miller) capacitance					pF	
Q_g	total gate charge	$V_{CE} = 600\text{ V}; V_{GE} = 0\text{ V}/15\text{ V}; I_C = 150\text{ A}$		520		nC	
Q_{gs}	gate source charge					nC	
Q_{gd}	gate drain (Miller) charge					nC	
$t_{d(on)}$	turn-on delay time	Inductive switching $V_{CE} = 600\text{ V}; I_C = 150\text{ A}$ $V_{GE} = \pm 15\text{ V}; R_G = 4.7\ \Omega$ (external)	$T_{VJ} = 25^{\circ}\text{C}$		172	ns	
t_r	current rise time				62	ns	
$t_{d(off)}$	turn-off delay time				296	ns	
t_f	current fall time				162	ns	
E_{on}	turn-on energy per pulse				14.2	mJ	
E_{off}	turn-off energy per pulse				12.8	mJ	
$E_{rec(off)}$	reverse recovery losses at turn-off				4.1	mJ	
$t_{d(on)}$	turn-on delay time	Inductive switching $V_{CE} = 600\text{ V}; I_C = 150\text{ A}$ $V_{GE} = \pm 15\text{ V}; R_G = 4.7\ \Omega$ (external)	$T_{VJ} = 100^{\circ}\text{C}$		180	ns	
t_r	current rise time				70	ns	
$t_{d(off)}$	turn-off delay time				336	ns	
t_f	current fall time				216	ns	
E_{on}	turn-on energy per pulse				17.7	mJ	
E_{off}	turn-off energy per pulse				15.7	mJ	
$E_{rec(off)}$	reverse recovery losses at turn-off				6.8	mJ	
$t_{d(on)}$	turn-on delay time	Inductive switching $V_{CE} = 600\text{ V}; I_C = 150\text{ A}$ $V_{GE} = \pm 15\text{ V}; R_G = 4.7\ \Omega$ (external)	$T_{VJ} = 150^{\circ}\text{C}$		108	ns	
t_r	current rise time				76	ns	
$t_{d(off)}$	turn-off delay time				360	ns	
t_f	current fall time				256	ns	
E_{on}	turn-on energy per pulse				20.9	mJ	
E_{off}	turn-off energy per pulse				17.4	mJ	
$E_{rec(off)}$	reverse recovery losses at turn-off				9.3	mJ	
RBSOA	reverse bias safe operating area	$V_{GE} = \pm 15\text{ V}; R_G = 4.7\ \Omega$ $V_{CEmax} = 1200\text{ V}$	$T_{VJ} = 150^{\circ}\text{C}$			A	
I_{CM}						400	A
SCSOA	short circuit safe operating area	$V_{CEmax} = 1200\text{ V}$ $V_{CE} = 900\text{ V}; V_{GE} = \pm 15\text{ V}$ non-repetitive	$T_{VJ} = 150^{\circ}\text{C}$			μs	
t_{SC}	short circuit duration					10	μs
I_{SC}	short circuit current				600		A
R_{thJC}	thermal resistance junction to case	with heatsink compound; IXYS test setup		0.22	0.18	K/W	
R_{thJH}	thermal resistance junction to heatsink					K/W	



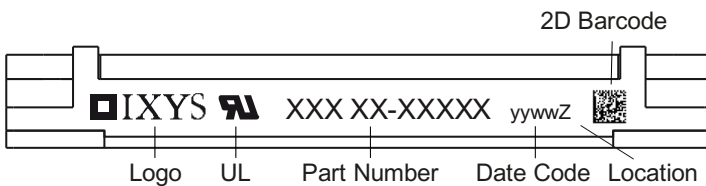
Inverter Diode D1 - D6				Ratings			
Symbol	Definitions	Conditions	min.	typ.	max.		
V_{RRM}	max. repetitive reverse voltage				1200	V	
I_{F25}	forward current				225	A	
I_{F80}					162	A	
I_{F100}					136	A	
V_F	forward voltage	$I_F = 150$ A		1.7	2.0	V	
				1.7		V	
I_R	reverse current * not applicable, see Ices at IGBT	$V_R = V_{RRM}$		*	*	mA mA	
di/dt	rate of change of current	$V_{CE} = 600$ V; $I_C = 150$ A $V_{GE} = \pm 15$ V; $R_G = 4.7$ Ω (external)		2550		A/ μ s	
Q_{RM}	reverse recovery charge					12	μ C
I_{RM}	max. reverse recovery current					103	A
t_{rr}	reverse recovery time					346	ns
E_{rec}	reverse recovery energy					4.1	mJ
di/dt	rate of change of current	$V_{CE} = 600$ V; $I_C = 150$ A $V_{GE} = \pm 15$ V; $R_G = 4.7$ Ω (external)		2210		A/ μ s	
Q_{RM}	reverse recovery charge					19	μ C
I_{RM}	max. reverse recovery current					114	A
t_{rr}	reverse recovery time					458	ns
E_{rec}	reverse recovery energy					6.8	mJ
di/dt	rate of change of current	$V_{CE} = 600$ V; $I_C = 150$ A $V_{GE} = \pm 15$ V; $R_G = 4.7$ Ω (external)		2040		A/ μ s	
Q_{RM}	reverse recovery charge					25	μ C
I_{RM}	max. reverse recovery current					125	A
t_{rr}	reverse recovery time					540	ns
E_{rec}	reverse recovery energy					9.3	mJ
R_{thJC}	thermal resistance junction to case	with heatsink compound; IXYS test setup			0.30	K/W	
R_{thJH}	thermal resistance junction to heatsink				0.38	K/W	

Temperature Sensor NTC						
Symbol	Definitions	Conditions	min.	typ.	max.	Unit
R_{25}	resistance	$T_{VJ} = 25^\circ\text{C}$	4.75	5.0	5.25	k Ω
$B_{25/50}$	temperature coefficient			3375		K

Equivalent Circuits for Simulation <small>*on die level</small>						
			IGBT	Inverter Diode		
$V_{0\max}$	threshold voltage	$T_{VJ} = 175^\circ\text{C}$	1.2	1.2		V
$R_{0\max}$	slope resistance *		7.7	4.7		m Ω



Package E3-Pack			Ratings			
Symbol	Definitions	Conditions	min.	typ.	max.	Unit
I_{RMS}	RMS current	per terminal		50		A
T_{stg}	storage temperature		-40		125	°C
T_{op}	operation temperature		-40		150	°C
T_{vJ}	virtual junction temperature		-40		175	°C
Weight				270		g
M_D	mounting torque		3		6	Nm
d_{Spp}	creepage distance on surface	terminal to terminal	6			mm
d_{Spb}		terminal to backside	12			mm
d_{App}	striking distance through air	terminal to terminal	6			mm
d_{Appb}		terminal to backside	12			mm
V_{ISOL}	isolation voltage	50/60 Hz, RMS; $I_{ISOL} \leq 1$ mA	$t = 1$ second 4300 $t = 1$ minute 3600			V V
$R_{pin-chip}$	resistance pin to chip	$V = V_{CEsat} + 2 \cdot R \cdot I_C$ resp. $V = V_F + 2 \cdot R \cdot I_F$		2.3		mΩ
C_p	coupling capacity per switch	between shorted pins of switch and back side metallization				pF


Part number

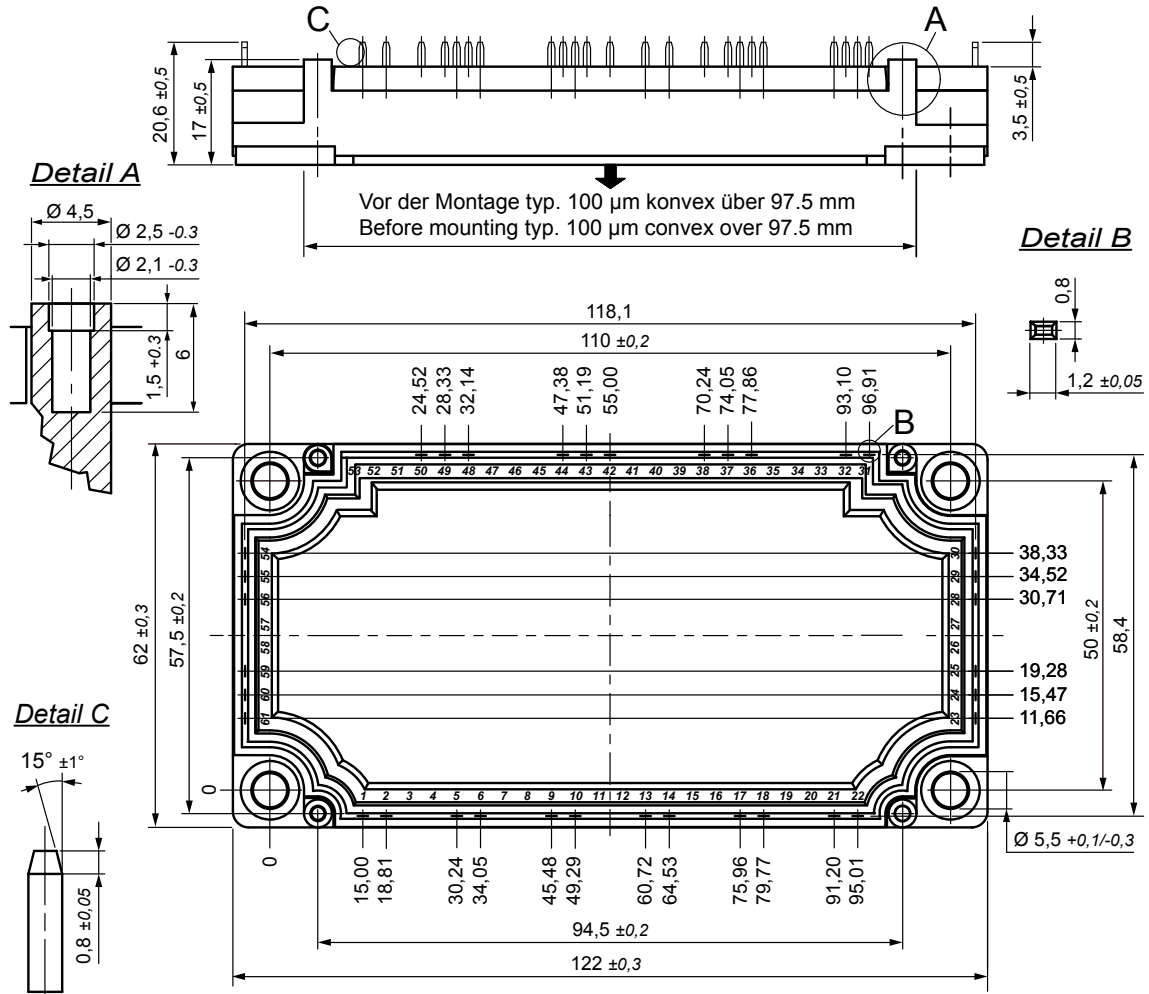
M = Module
 I = IGBT
 X = XPT IGBT
 G = Gen 2 / std
 180 = Current Rating [A]
 W = 6-pack
 1200 = Reverse Voltage [V]
 T = Thermistor
 EH = E3-Pack

Ordering	Part Name	Marking on Product	Delivering Mode	Base Qty	Ordering Code
Standard	MIXG180W1200TEH	MIXG180W1200TEH	Box	5	MIXG180W1200TEH
with Phase Change Material	MIXG180W1200TEH-PC	MIXG180W1200TEH	Blister	24	

Similar Part	Package	Voltage class
MIXG180W1200PTEH	E3- Pack, press fit pin	1200
MIXG180W1200STEH	E3- Pack, shunt	1200
MIXG180W1200PSTEH	E3- Pack, shunt and press fit pin	1200

Option: phase change material; please contact IXYS sales office for availability

Outlines E3-Pack

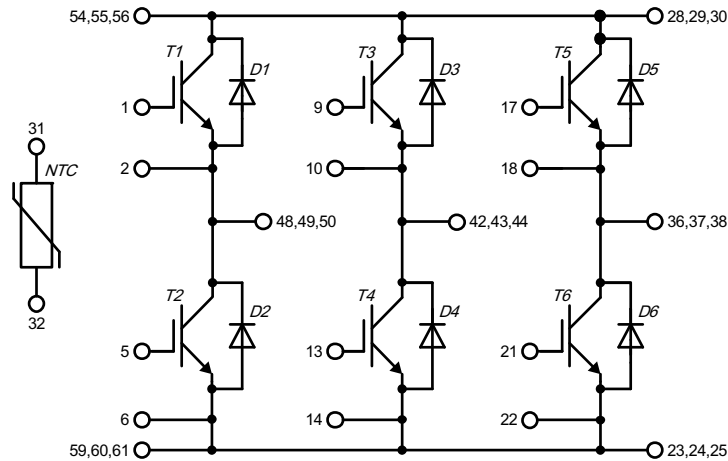


Bemerkung / Note:

- Nichttolerierte Maße nach / Measure without tolerances according DIN ISO 2768-T1-m
- PCB-Lochmuster / PCB hole pattern: **see pin position**
- Toleranz Pin-Position und PCB-Lochmuster / Tolerance of pin position and PCB hole pattern: $\oplus 0.1$
- Montageanleitung / Mounting instruction: www.ixys.com **Application note IXAN0024**

Detail A: PCB-Montage / Mounting on PCB

- Empfohlene, selbstschneidende Schraube / Recommended, self-tapping screw: **EJOT PT®** (Größe / size: **K25**)
- Max. Schraubenlänge / Max. screw length: **PCB-Dicke / thickness + 6 mm** (max. Lochtiefe / hole depth)
- Empfohlenes Drehmoment / Recommended mounting torque: **1.5 Nm**



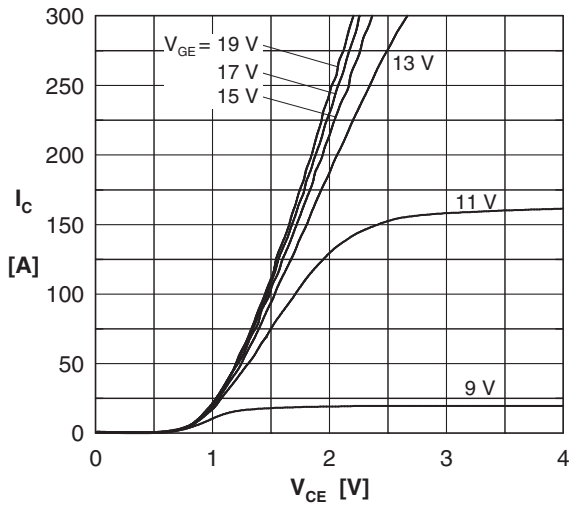
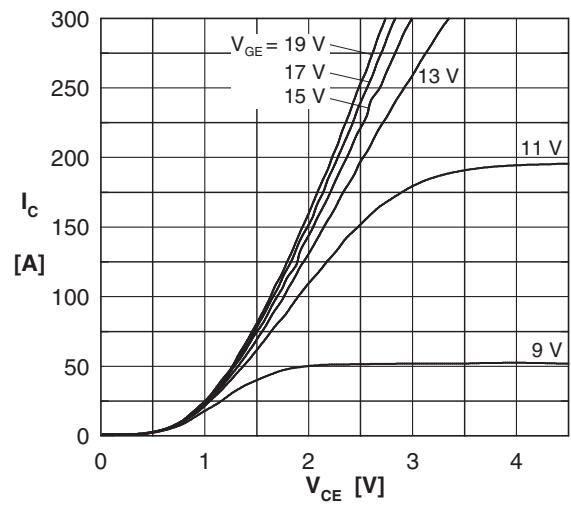
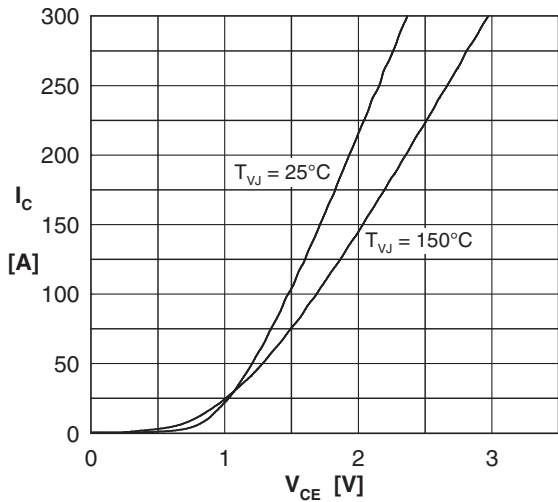
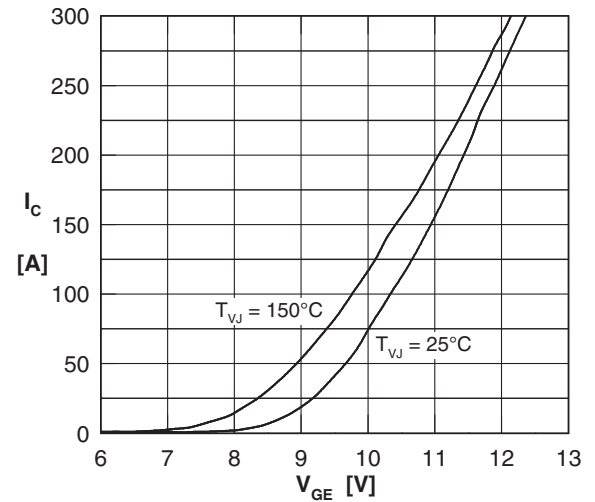
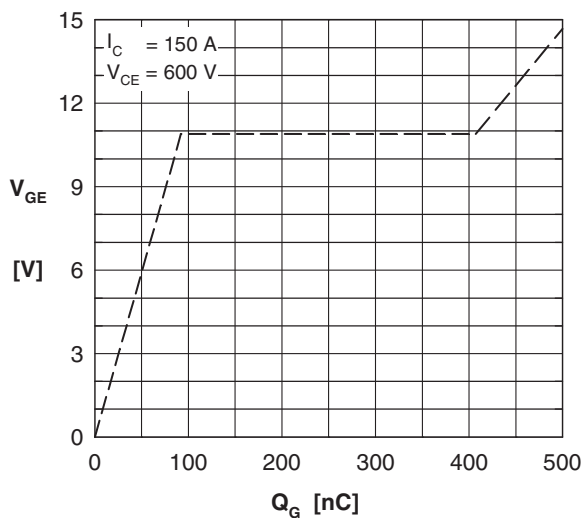
IGBT T1 - T6

 Fig. 1 Typ. output characteristics ($T_{VJ} = 25^\circ\text{C}$)

 Fig. 2 Typ. output characteristics ($T_{VJ} = 150^\circ\text{C}$)

 Fig. 3 Typ. output characteristics ($V_{GE} = 15\text{ V}$)

 Fig. 4 Typ. transfer characteristics ($V_{CE} = 20\text{ V}$)


Fig. 5 Typ. turn-on gate charge 0/15V

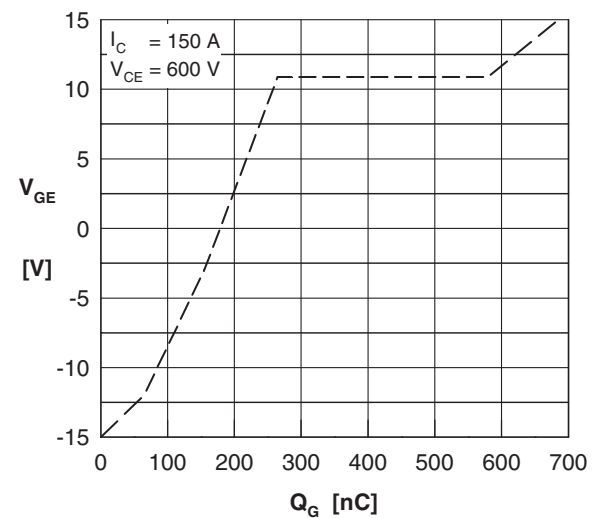


Fig. 6 Typ. turn-on gate charge -15/+15V

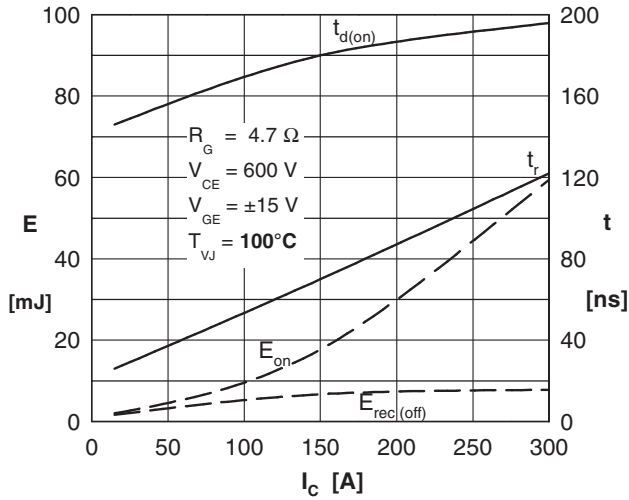
IGBT T1 - T6


Fig. 7 Typ. switching energy versus collector current (turn on)

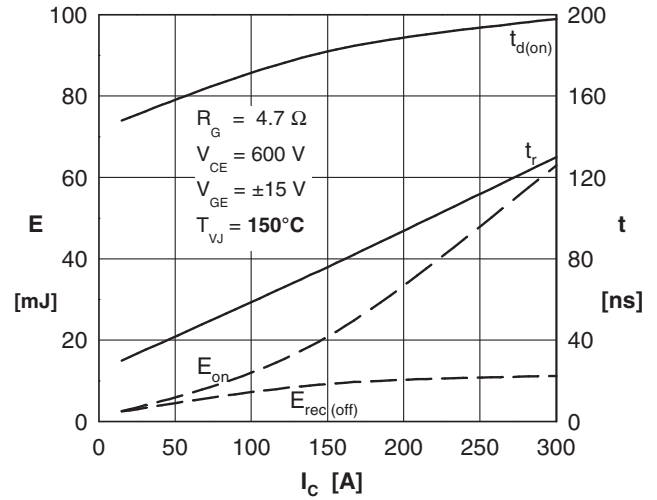


Fig. 8 Typ. switching energy versus collector current (turn on)

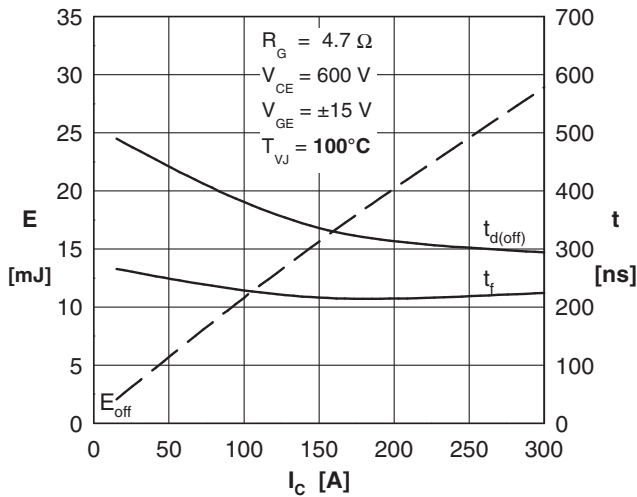


Fig. 9 Typ. switching energy versus collector current (turn off)

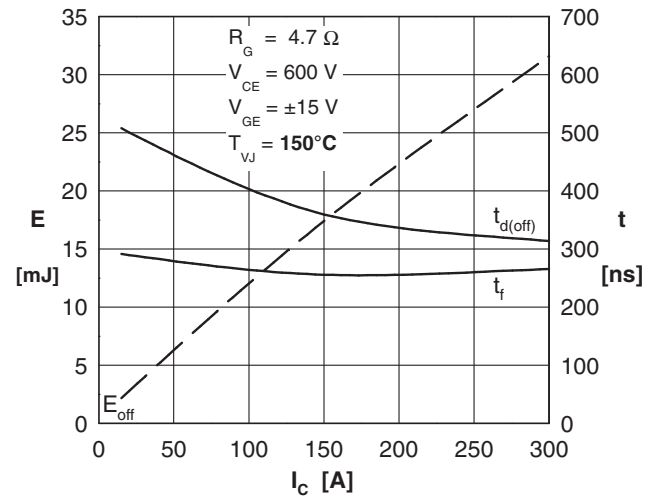


Fig. 10 Typ. switching energy versus collector current (turn off)

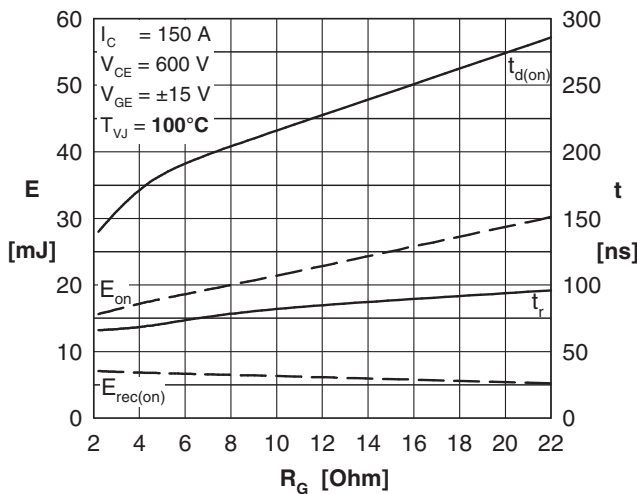


Fig. 11 Typ. switching energy versus gate resistor (turn on)

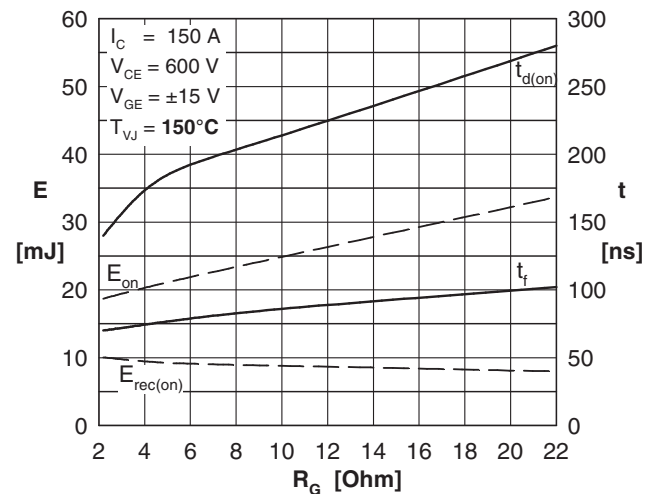


Fig. 12 Typ. switching energy versus gate resistor (turn on)

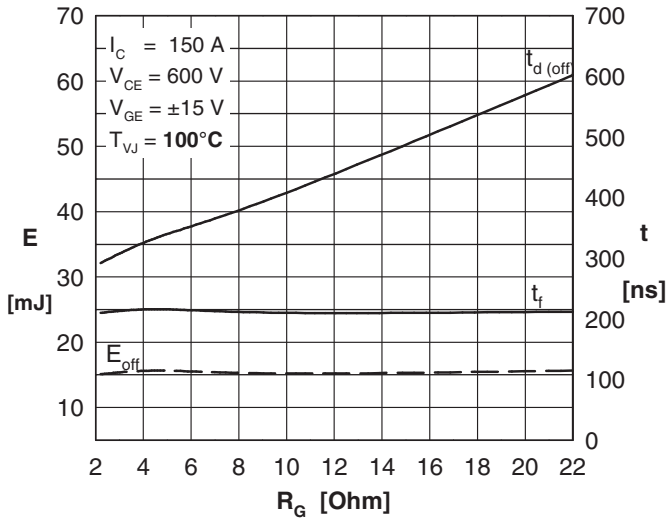
IGBT T1 - T6


Fig. 13 Typ. switching energy versus gate resistor (turn off)

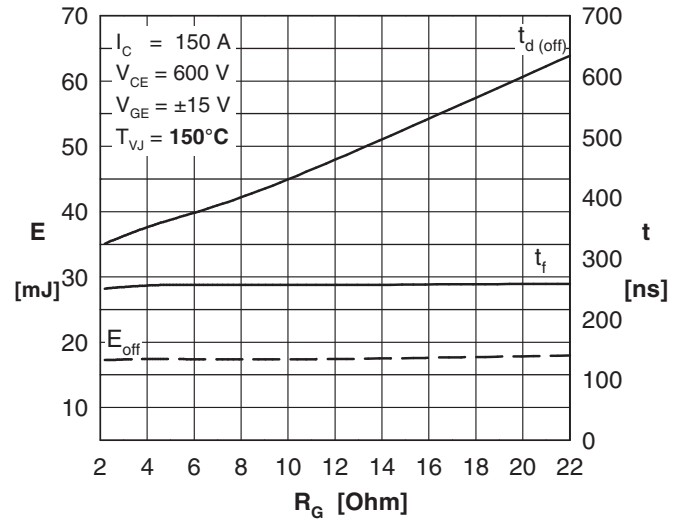


Fig. 14 Typ. switching energy versus gate resistor (turn off)

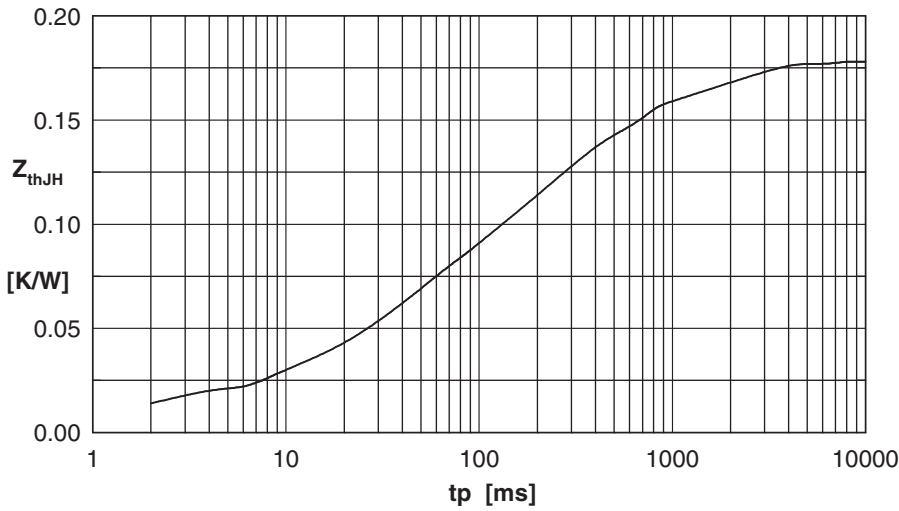


Fig. 15 IGBT: typ. transient thermal impedance to heat sink

DIODE D1 - D6

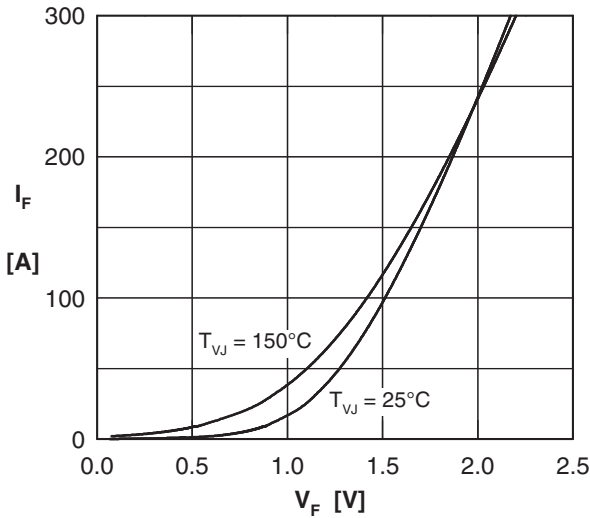


Fig. 16 FWD: typ. forward characteristics

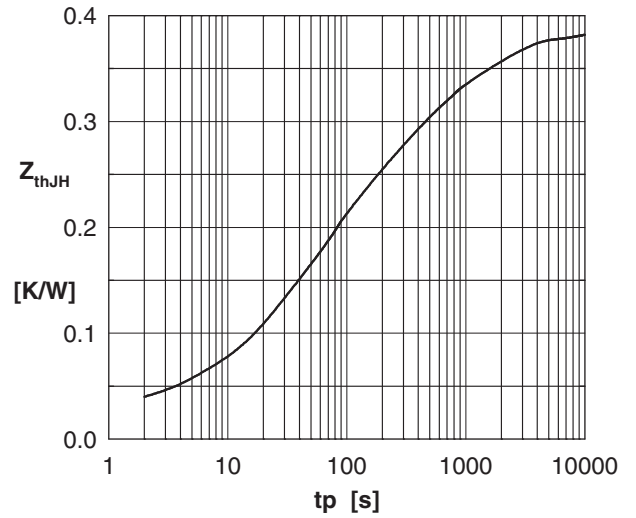


Fig. 17 Diode: typical transient thermal impedance junction to heat sink

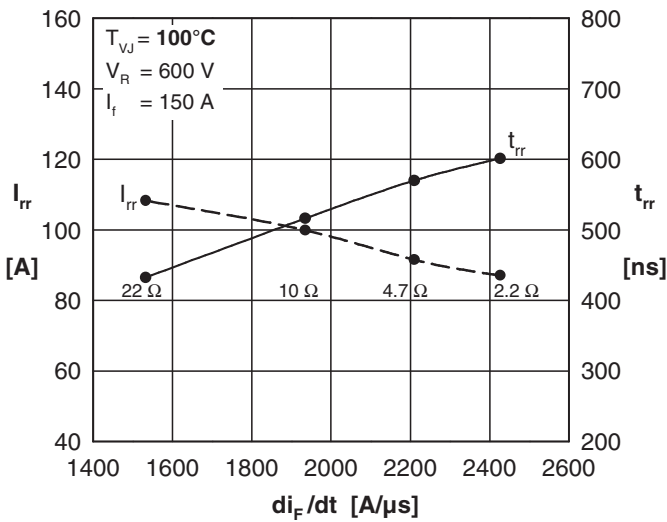


Fig. 18 Typ. recovery energy $E_{rec(off)}$ versus $-di/dt$

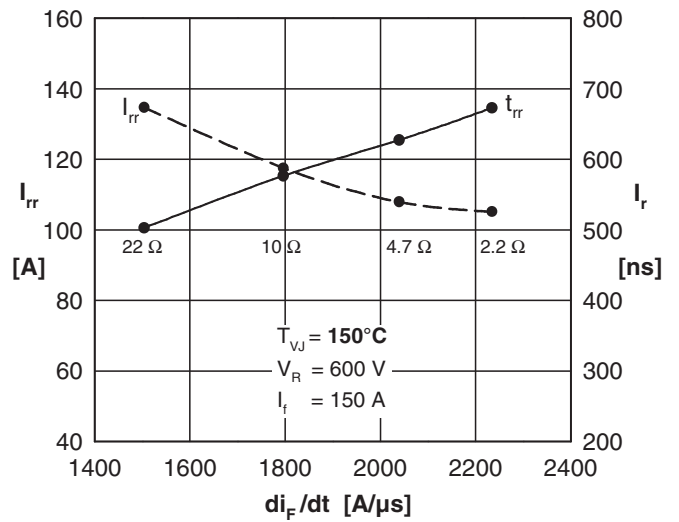


Fig. 19 Typ. recovery energy $E_{rec(off)}$ versus $-di/dt$