

# XPT IGBT Module

3~ Rectifier	Brake Chopper	3~ Inverter
$V_{RRM} = 1600 \text{ V}$	$V_{CES} = 1200 \text{ V}$	$V_{CES} = 1200 \text{ V}$
$I_{DAV} = 135 \text{ A}$	$I_{C25} = 60 \text{ A}$	$I_{C25} = 85 \text{ A}$
$I_{TSM} = 700 \text{ A}$	$V_{CE(sat)} = 1.8 \text{ V}$	$V_{CE(sat)} = 1.8 \text{ V}$

6-Pack + 3~ Rectifier Bridge, half-controlled (high-side) & Brake Unit + NTC

Part number

**MIXA60WH1200TEH**

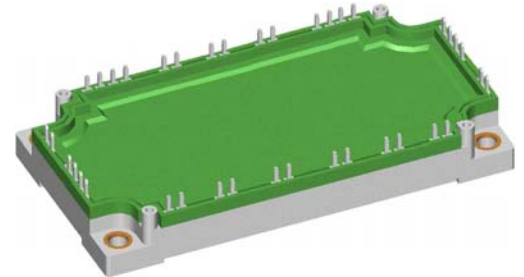

Backside: isolated

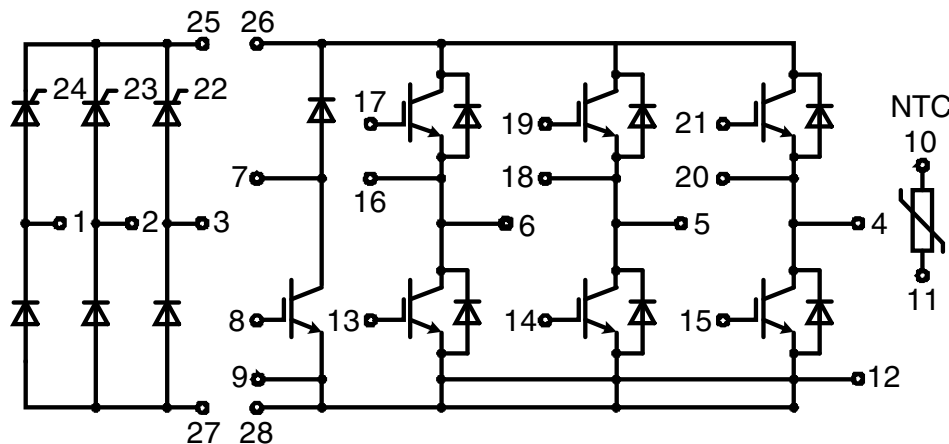

### Features / Advantages:

- Thyristor/Standard Rectifier for line frequency
- Easy paralleling due to the positive temperature coefficient of the on-state voltage
- Rugged XPT design (Xtreme light Punch Through) results in:
  - short circuit rated for 10  $\mu\text{sec}$ .
  - very low gate charge
  - low EMI
  - square RBSOA @ 3x  $I_c$
- Thin wafer technology combined with the XPT design results in a competitive low  $V_{CE(sat)}$
- SONIC™ diode
  - fast and soft reverse recovery
  - low operating forward voltage

### Applications:

- AC motor drives
- Solar inverter
- Medical equipment
- Uninterruptible power supply
- Air-conditioning systems
- Welding equipment
- Switched-mode and resonant-mode power supplies
- Inductive heating, cookers
- Pumps, Fans

### Package:

- Housing: E3-Pack
- International standard package
- RoHS compliant
- Isolation voltage: 3600 V~
- Advanced power cycling

Rectifier			Ratings			
Symbol	Definition	Conditions	min.	typ.	max.	Unit
$V_{RSM/DSM}$	max. non-repetitive reverse/forward blocking voltage	$T_{VJ} = 25^{\circ}\text{C}$			1700	V
$V_{RRM/DRM}$	max. repetitive reverse/forward blocking voltage	$T_{VJ} = 25^{\circ}\text{C}$			1600	V
$I_{RD}$	reverse current, drain current	$V_{R/D} = 1600\text{ V}$	$T_{VJ} = 25^{\circ}\text{C}$		100	$\mu\text{A}$
		$V_{R/D} = 1600\text{ V}$	$T_{VJ} = 150^{\circ}\text{C}$		20	mA
$V_T$	forward voltage drop	$I_T = 80\text{ A}$	$T_{VJ} = 25^{\circ}\text{C}$		1.43	V
		$I_T = 160\text{ A}$			1.86	V
		$I_T = 80\text{ A}$	$T_{VJ} = 125^{\circ}\text{C}$		1.42	V
		$I_T = 160\text{ A}$			1.97	V
$I_{DAV}$	bridge output current	$T_C = 80^{\circ}\text{C}$	$T_{VJ} = 150^{\circ}\text{C}$		135	A
		180° sine $d = 1/3$				
$V_{T0}$	threshold voltage	} for power loss calculation only	$T_{VJ} = 150^{\circ}\text{C}$		0.85	V
$r_T$	slope resistance				7.1	m $\Omega$
$R_{thJC}$	thermal resistance junction to case				0.65	K/W
$R_{thCH}$	thermal resistance case to heatsink			0.10		K/W
$P_{tot}$	total power dissipation		$T_C = 25^{\circ}\text{C}$		190	W
$I_{TSM}$	max. forward surge current	$t = 10\text{ ms}; (50\text{ Hz}), \text{ sine}$	$T_{VJ} = 45^{\circ}\text{C}$		700	A
		$t = 8,3\text{ ms}; (60\text{ Hz}), \text{ sine}$	$V_R = 0\text{ V}$		755	A
		$t = 10\text{ ms}; (50\text{ Hz}), \text{ sine}$	$T_{VJ} = 150^{\circ}\text{C}$		595	A
		$t = 8,3\text{ ms}; (60\text{ Hz}), \text{ sine}$	$V_R = 0\text{ V}$		645	A
$I^2t$	value for fusing	$t = 10\text{ ms}; (50\text{ Hz}), \text{ sine}$	$T_{VJ} = 45^{\circ}\text{C}$		2.45	kA <sup>2</sup> s
		$t = 8,3\text{ ms}; (60\text{ Hz}), \text{ sine}$	$V_R = 0\text{ V}$		2.37	kA <sup>2</sup> s
		$t = 10\text{ ms}; (50\text{ Hz}), \text{ sine}$	$T_{VJ} = 150^{\circ}\text{C}$		1.77	kA <sup>2</sup> s
		$t = 8,3\text{ ms}; (60\text{ Hz}), \text{ sine}$	$V_R = 0\text{ V}$		1.73	kA <sup>2</sup> s
$C_J$	junction capacitance	$V_R = 400\text{ V}$ $f = 1\text{ MHz}$	$T_{VJ} = 25^{\circ}\text{C}$		32	pF
$P_{GM}$	max. gate power dissipation	$t_p = 30\text{ }\mu\text{s}$	$T_C = 150^{\circ}\text{C}$		10	W
		$t_p = 300\text{ }\mu\text{s}$			5	W
$P_{GAV}$	average gate power dissipation				0.5	W
$(di/dt)_{cr}$	critical rate of rise of current	$T_{VJ} = 125^{\circ}\text{C}; f = 50\text{ Hz}$ repetitive, $I_T = 150\text{ A}$			100	A/ $\mu\text{s}$
		$t_p = 200\text{ }\mu\text{s}; di_G/dt = 0.45\text{ A}/\mu\text{s}$ non-repet., $I_T = 45\text{ A}$			500	A/ $\mu\text{s}$
$(dv/dt)_{cr}$	critical rate of rise of voltage	$V_D = 2/3 V_{DRM}$	$T_{VJ} = 125^{\circ}\text{C}$		1000	V/ $\mu\text{s}$
		$R_{GK} = \infty$ ; method 1 (linear voltage rise)				
$V_{GT}$	gate trigger voltage	$V_D = 6\text{ V}$	$T_{VJ} = 25^{\circ}\text{C}$		1.5	V
			$T_{VJ} = -40^{\circ}\text{C}$		1.6	V
$I_{GT}$	gate trigger current	$V_D = 6\text{ V}$	$T_{VJ} = 25^{\circ}\text{C}$		78	mA
			$T_{VJ} = -40^{\circ}\text{C}$		200	mA
$V_{GD}$	gate non-trigger voltage	$V_D = 2/3 V_{DRM}$	$T_{VJ} = 125^{\circ}\text{C}$		0.2	V
$I_{GD}$	gate non-trigger current				5	mA
$I_L$	latching current	$t_p = 10\text{ }\mu\text{s}$	$T_{VJ} = 25^{\circ}\text{C}$		450	mA
		$I_G = 10\text{ A}; di_G/dt = 0.45\text{ A}/\mu\text{s}$				
$I_H$	holding current	$V_D = 6\text{ V}$ $R_{GK} = \infty$	$T_{VJ} = 25^{\circ}\text{C}$		100	mA
$t_{gd}$	gate controlled delay time	$V_D = 1/2 V_{DRM}$	$T_{VJ} = 25^{\circ}\text{C}$		2	$\mu\text{s}$
		$I_G = 0.45\text{ A}; di_G/dt = 0.45\text{ A}/\mu\text{s}$				
$t_q$	turn-off time	$V_R = 100\text{ V}; I_T = 20\text{ A}; V_D = 2/3 V_{DRM}$ $T_{VJ} = 150^{\circ}\text{C}$			150	$\mu\text{s}$
		$di/dt = 10\text{ A}/\mu\text{s}; dv/dt = 15\text{ V}/\mu\text{s}; t_p = 200\text{ }\mu\text{s}$				

Brake IGBT				Ratings					
Symbol	Definition	Conditions	min.	typ.	max.	Unit			
$V_{CES}$	collector emitter voltage	$T_{VJ} = 25^{\circ}\text{C}$			1200	V			
$V_{GES}$	max. DC gate voltage				$\pm 20$	V			
$V_{GEM}$	max. transient collector gate voltage				$\pm 30$	V			
$I_{C25}$	collector current	$T_C = 25^{\circ}\text{C}$			60	A			
$I_{C80}$		$T_C = 80^{\circ}\text{C}$			40	A			
$P_{tot}$	total power dissipation	$T_C = 25^{\circ}\text{C}$			195	W			
$V_{CE(sat)}$	collector emitter saturation voltage	$I_C = 35\text{ A}; V_{GE} = 15\text{ V}$			1.8	V			
					2.1	V			
$V_{GE(th)}$	gate emitter threshold voltage	$I_C = 1.5\text{ mA}; V_{GE} = V_{CE}$	5.4	5.9	6.5	V			
$I_{CES}$	collector emitter leakage current	$V_{CE} = V_{CES}; V_{GE} = 0\text{ V}$			0.1	mA			
					0.1	mA			
$I_{GES}$	gate emitter leakage current	$V_{GE} = \pm 20\text{ V}$			500	nA			
$Q_{G(on)}$	total gate charge	$V_{CE} = 600\text{ V}; V_{GE} = 15\text{ V}; I_C = 35\text{ A}$		106		nC			
$t_{d(on)}$	turn-on delay time	inductive load $V_{CE} = 600\text{ V}; I_C = 35\text{ A}$ $V_{GE} = \pm 15\text{ V}; R_G = 27\ \Omega$							
$t_r$	current rise time						$T_{VJ} = 125^{\circ}\text{C}$	70	ns
$t_{d(off)}$	turn-off delay time						40	ns	
$t_f$	current fall time						250	ns	
$E_{on}$	turn-on energy per pulse						100	mJ	
$E_{off}$	turn-off energy per pulse						3.8	mJ	
$E_{off}$		4.1	mJ						
<b>RBSOA</b>	reverse bias safe operating area	$V_{GE} = \pm 15\text{ V}; R_G = 27\ \Omega$							
$I_{CM}$		$V_{CEK} = 1200\text{ V}$			105	A			
<b>SCSOA</b>	short circuit safe operating area								
$t_{SC}$	short circuit duration	$V_{CE} = 900\text{ V}; V_{GE} = \pm 15\text{ V}$			10	$\mu\text{s}$			
$I_{SC}$	short circuit current	$R_G = 27\ \Omega$ ; non-repetitive		140		A			
$R_{thJC}$	thermal resistance junction to case				0.64	K/W			
$R_{thCH}$	thermal resistance case to heatsink			0.10		K/W			
<b>Brake Diode</b>									
$V_{RRM}$	max. repetitive reverse voltage				1200	V			
$I_{F25}$	forward current				44	A			
$I_{F80}$					29	A			
$V_F$	forward voltage	$I_F = 30\text{ A}$			2.20	V			
					1.95	V			
$I_R$	reverse current	$V_R = V_{RRM}$			0.1	mA			
					0.15	mA			
$Q_{rr}$	reverse recovery charge	$V_R = 600\text{ V}$ $-di_F/dt = 600\text{ A}/\mu\text{s}$ $I_F = 30\text{ A}$							
$I_{RM}$	max. reverse recovery current						$T_{VJ} = 125^{\circ}\text{C}$	3.5	$\mu\text{C}$
$t_{rr}$	reverse recovery time						30	A	
$E_{rec}$	reverse recovery energy						350	ns	
$R_{thJC}$	thermal resistance junction to case				1.2	K/W			
$R_{thCH}$	thermal resistance case to heatsink			0.10		K/W			

Inverter IGBT				Ratings			
Symbol	Definition	Conditions	min.	typ.	max.	Unit	
$V_{CES}$	collector emitter voltage	$T_{VJ} = 25^{\circ}\text{C}$			1200	V	
$V_{GES}$	max. DC gate voltage				$\pm 20$	V	
$V_{GEM}$	max. transient collector gate voltage				$\pm 30$	V	
$I_{C25}$	collector current	$T_C = 25^{\circ}\text{C}$			85	A	
$I_{C80}$		$T_C = 80^{\circ}\text{C}$			60	A	
$P_{tot}$	total power dissipation	$T_C = 25^{\circ}\text{C}$			290	W	
$V_{CE(sat)}$	collector emitter saturation voltage	$I_C = 55\text{ A}; V_{GE} = 15\text{ V}$			1.8	V	
					2.1	V	
$V_{GE(th)}$	gate emitter threshold voltage	$I_C = 2\text{ mA}; V_{CE} = V_{CE}$	5.4	5.9	6.5	V	
$I_{CES}$	collector emitter leakage current	$V_{CE} = V_{CES}; V_{GE} = 0\text{ V}$			0.5	mA	
					0.2	mA	
$I_{GES}$	gate emitter leakage current	$V_{GE} = \pm 20\text{ V}$			500	nA	
$Q_{G(on)}$	total gate charge	$V_{CE} = 600\text{ V}; V_{GE} = 15\text{ V}; I_C = 55\text{ A}$		165		nC	
$t_{d(on)}$	turn-on delay time	inductive load $V_{CE} = 600\text{ V}; I_C = 55\text{ A}$ $V_{GE} = \pm 15\text{ V}; R_G = 15\ \Omega$		70		ns	
$t_r$	current rise time			40		ns	
$t_{d(off)}$	turn-off delay time			250		ns	
$t_f$	current fall time			100		ns	
$E_{on}$	turn-on energy per pulse			4.5		mJ	
$E_{off}$	turn-off energy per pulse			5.5		mJ	
$R_{BSOA}$	reverse bias safe operating area	$V_{GE} = \pm 15\text{ V}; R_G = 15\ \Omega$					
$I_{CM}$		$V_{CEmax} = 1200\text{ V}$			150	A	
$R_{SCSOA}$	short circuit safe operating area	$V_{CEmax} = 1200\text{ V}$					
$t_{sc}$	short circuit duration	$V_{CE} = 900\text{ V}; V_{GE} = \pm 15\text{ V}$			10	$\mu\text{s}$	
$I_{sc}$	short circuit current	$R_G = 15\ \Omega; \text{non-repetitive}$		200		A	
$R_{thJC}$	thermal resistance junction to case				0.43	K/W	
$R_{thCH}$	thermal resistance case to heatsink			0.10		K/W	
<b>Inverter Diode</b>							
$V_{RRM}$	max. repetitive reverse voltage	$T_{VJ} = 25^{\circ}\text{C}$			1200	V	
$I_{F25}$	forward current	$T_C = 25^{\circ}\text{C}$			88	A	
$I_{F80}$		$T_C = 80^{\circ}\text{C}$			59	A	
$V_F$	forward voltage	$I_F = 60\text{ A}$			2.20	V	
					1.95	V	
$I_R$	reverse current	$V_R = V_{RRM}$			0.3	mA	
					1.2	mA	
$Q_{rr}$	reverse recovery charge	$V_R = 600\text{ V}$ $-di_F/dt = 1200\text{ A}/\mu\text{s}$ $I_F = 60\text{ A}; V_{GE} = 0\text{ V}$		8		$\mu\text{C}$	
$I_{RM}$	max. reverse recovery current			60		A	
$t_{rr}$	reverse recovery time			350		ns	
$E_{rec}$	reverse recovery energy			2.5		mJ	
$R_{thJC}$	thermal resistance junction to case				0.6	K/W	
$R_{thCH}$	thermal resistance case to heatsink			0.10		K/W	

Package E3-Pack			Ratings			
Symbol	Definition	Conditions	min.	typ.	max.	Unit
$I_{RMS}$	RMS current	per terminal			300	A
$T_{stg}$	storage temperature		-40		125	°C
$T_{VJ}$	virtual junction temperature		-40		150	°C
<b>Weight</b>				270		g
$M_D$	mounting torque		3		6	Nm
$V_{ISOL}$	isolation voltage	t = 1 second	3600			V
		t = 1 minute	3000			V
$d_{Spp/App}$	creepage distance on surface   striking distance through air	terminal to terminal	6.0			mm
$d_{Spb/Apb}$		terminal to backside	12.0			mm

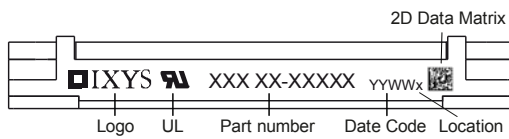

### Part number

- M = Module
- I = IGBT
- X = XPT IGBT
- A = Gen 1 / std
- 60 = Current Rating [A]
- WH = 6-Pack + 3~ Rectifier Bridge, half-controlled (high-side) & Brake Unit
- 1200 = Reverse Voltage [V]
- T = Thermistor \ Temperature sensor
- EH = E3-Pack

Ordering	Part Number	Marking on Product	Delivery Mode	Quantity	Code No.
Standard	MIXA60WH1200TEH	MIXA60WH1200TEH	Box	5	509622

Similar Part	Package	Voltage class
MIXA60WB1200TEH	E3-Pack	1200

### Temperature Sensor NTC

Symbol	Definition	Conditions	min.	typ.	max.	Unit
$R_{25}$	resistance	$T_{VJ} = 25^\circ$	4.75	5	5.25	k $\Omega$
$B_{25/50}$	temperature coefficient			3375		K

### Equivalent Circuits for Simulation

\* on die level

$T_{VJ} = 150^\circ\text{C}$

		Rectifier	Brake IGBT	Brake Diode	Inverter IGBT	Inverter Diode	
$V_0$	threshold voltage	0.85	1.1	1.2	1.1	1.22	V
$R_0$	slope resistance *	3.9	40	27	25.1	13	m $\Omega$

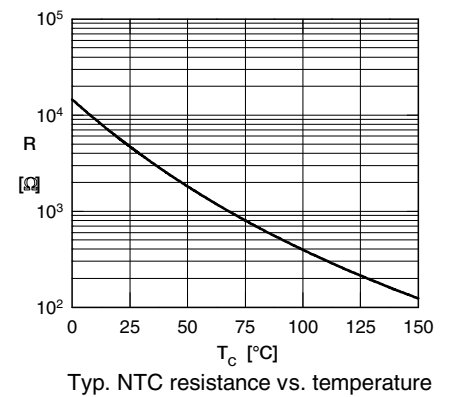

## Outlines E3-Pack

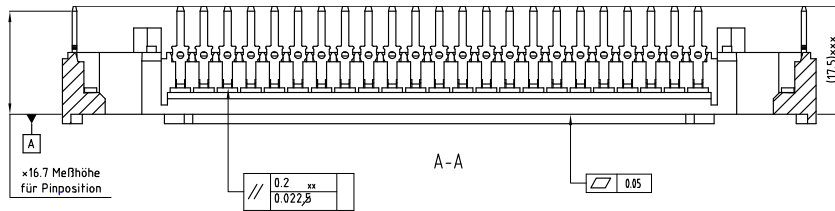

X  
5:1

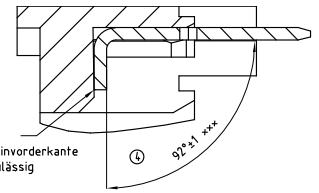

für alle Pins gilt:  
Spalt zwischen Pinvorderkante  
und Rahmen unzulässig

xx gemessen über alle Bondflächen  
zur Messung gespannt auf A

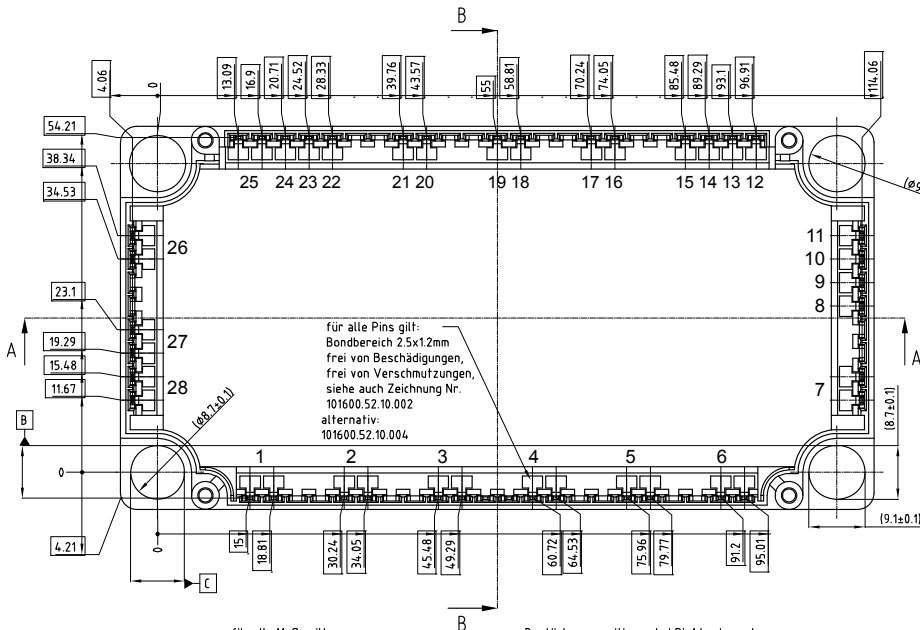

X

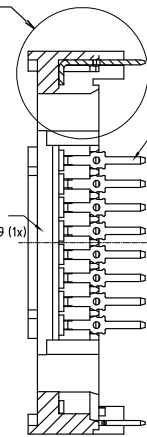

101600.52.10.002  
Art.-Nr. 4300076 (max. 61x)  
alternativ:  
101600.52.10.004  
Art.-Nr. 4300114 (max. 61x)

101700.52.10.001  
Art.-Nr. 4200089 (1x)

B-B

für alle Maße gilt:  
zur Messung gespannt auf A ×  
⌀ 0.3 B C

Bestückungspositionen bei Pin1 beginnend  
entgegen dem Uhrzeigersinn fortlaufend

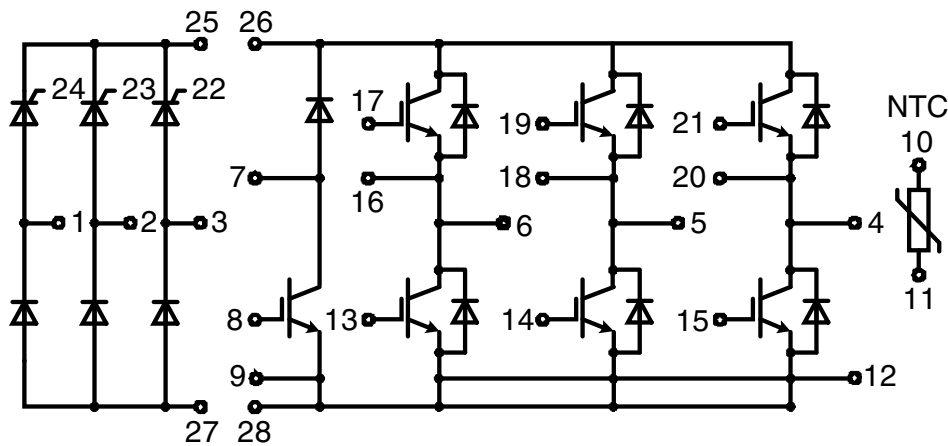

## Rectifier

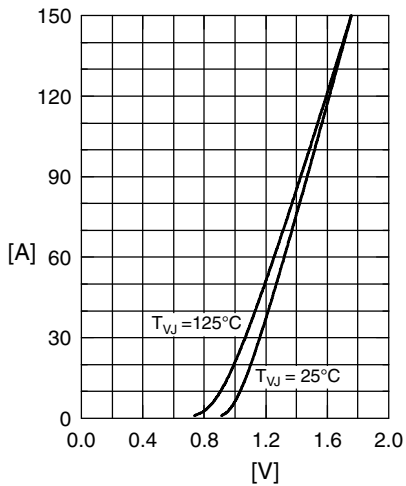

Fig.1 Forward current versus voltage drop per diode

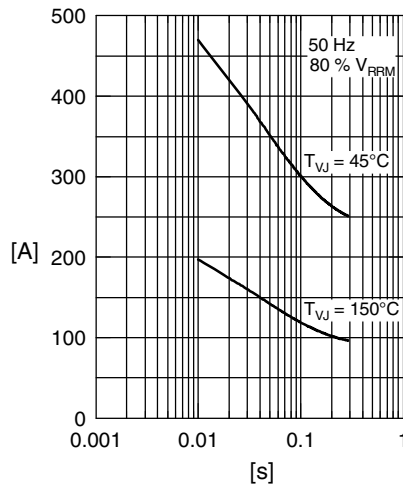

Fig.2 Surge overload current

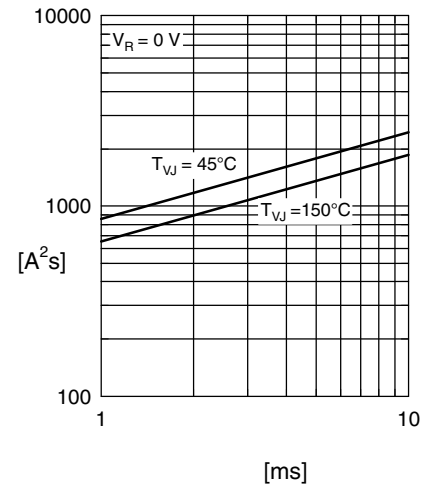

Fig.3  $I^2t$  versus time per diode

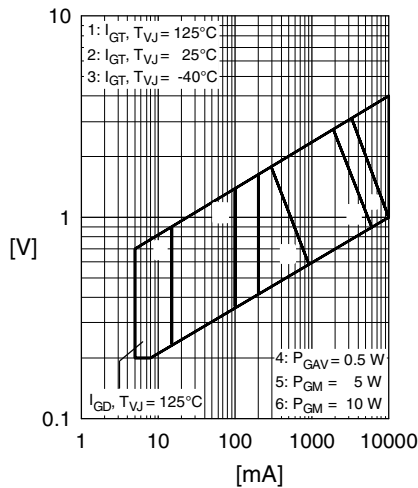

Fig. 4 Gate trigger characteristics

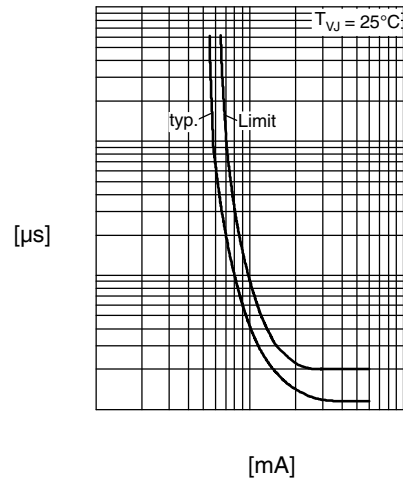

Fig. 5 Gate trigger delay time

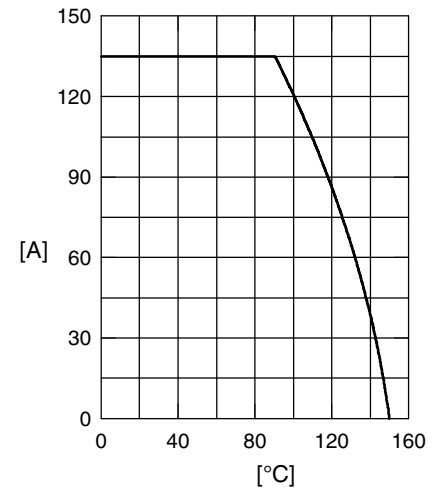

Fig. 6 Max. forward current versus case temperature

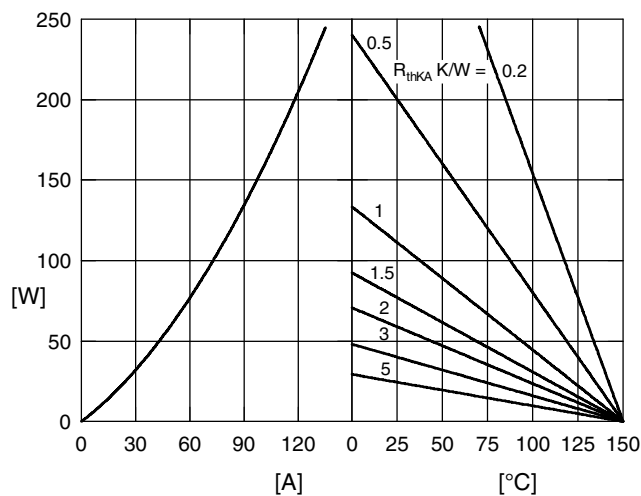

Fig.7 Power dissipation versus direct output current and ambient temperature, sine 180°

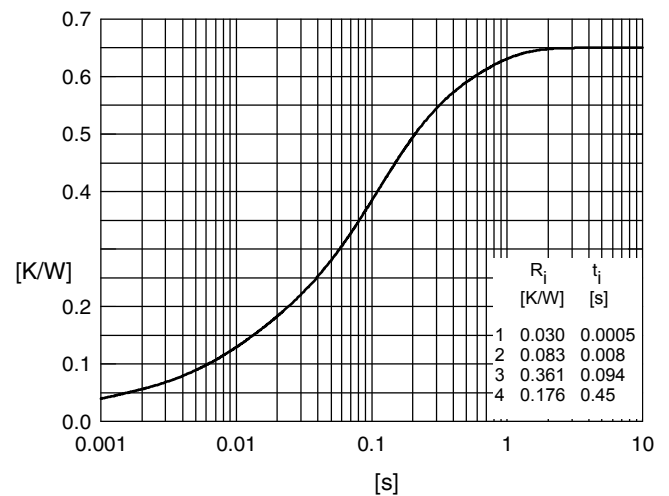

Fig. 8 Transient thermal impedance junction to case

## Brake IGBT

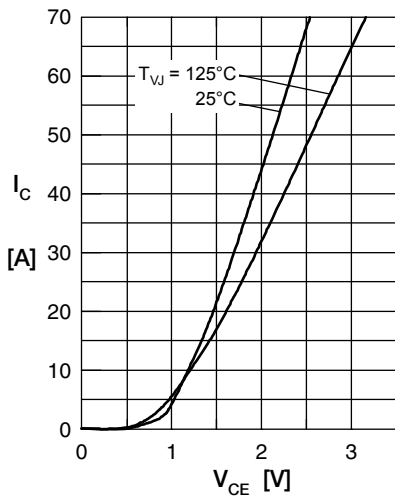

Fig. 1 Typ. output characteristics

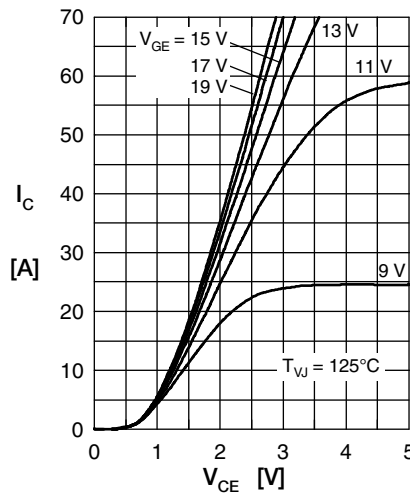

Fig. 2 Typ. output characteristics

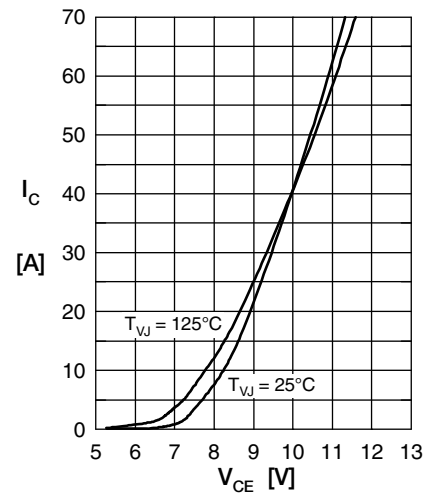

Fig. 3 Typ. transfer characteristics

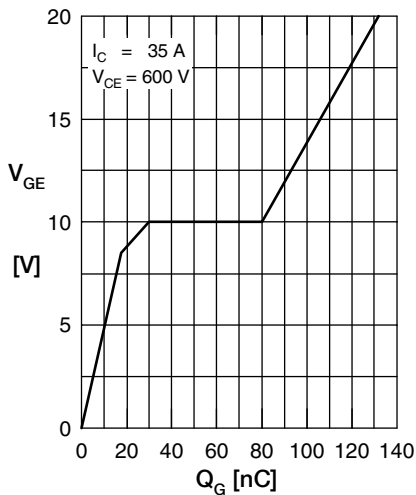

Fig. 4 Dynamic parameters  $Q_r$ ,  $I_{RM}$  versus  $T_{VJ}$

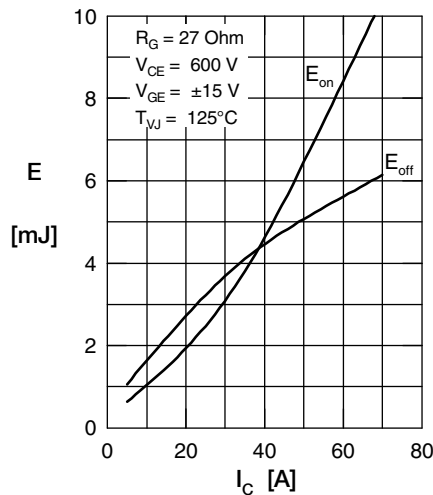

Fig. 5 Typ. recovery time  $t_{rr}$  versus  $-di_F/dt$

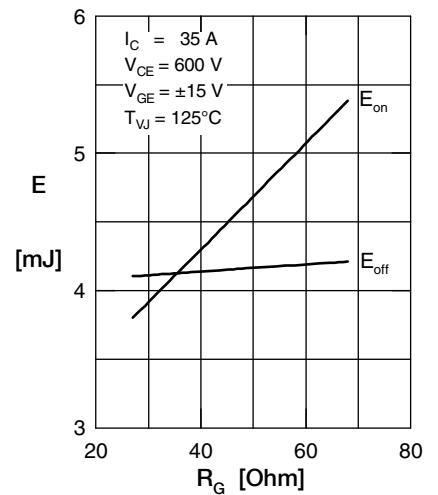

Fig. 6 Typ. peak forward voltage  $V_{FR}$  and  $t_{fr}$  versus  $di_F/dt$

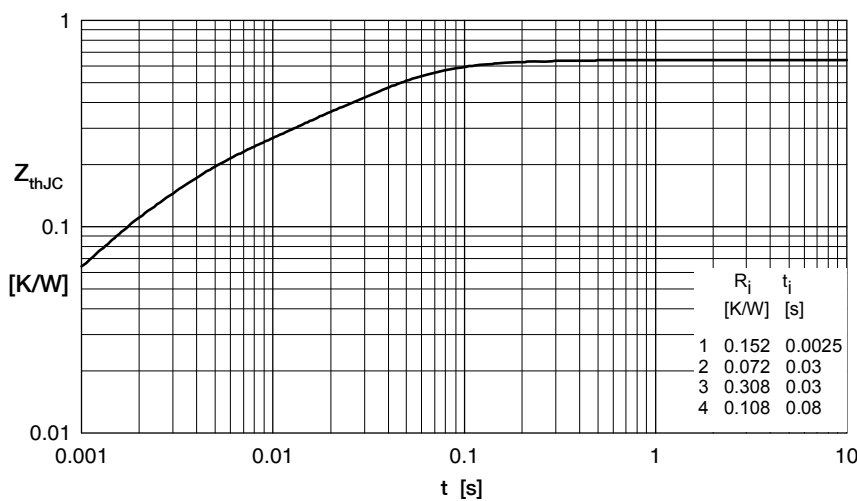

Fig. 7 Transient thermal impedance junction to case



## Brake Diode

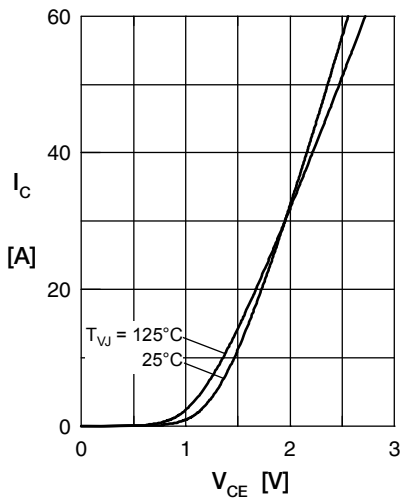

Fig. 1 Typ. Forward current versus  $V_F$

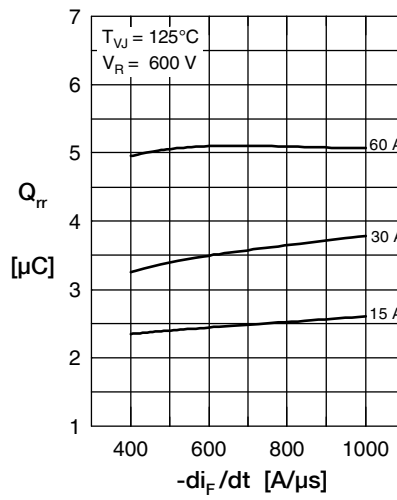

Fig. 2 Typ. reverse recovery charge  $Q_{rr}$  versus  $di/dt$

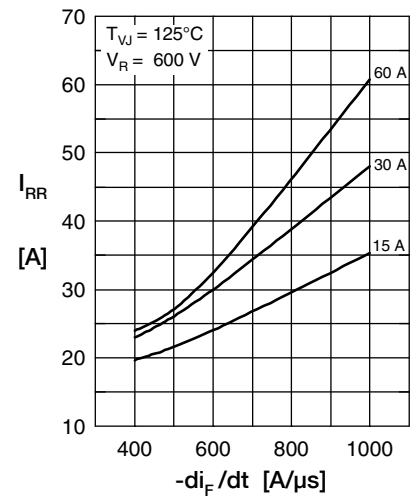

Fig. 3 Typ. peak reverse current  $I_{RM}$  versus  $di/dt$

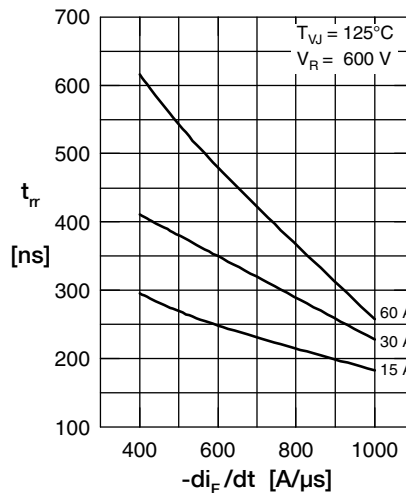

Fig. 4 Dynamic parameters  $Q_{rr}$ ,  $I_{RM}$  versus  $T_{WJ}$

Fig. 5 Typ. recovery time  $t_{rr}$  versus  $-di_F/dt$

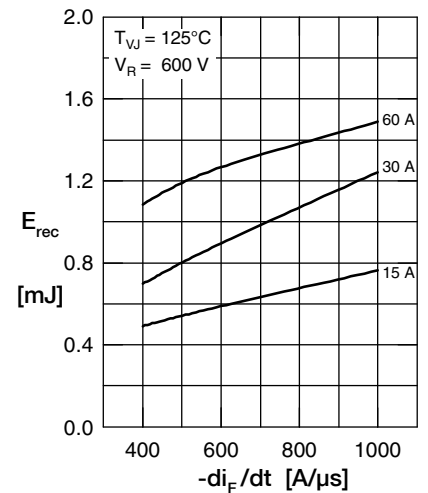

Fig. 6 Typ. recovery energy  $E_{rec}$  versus  $-di/dt$

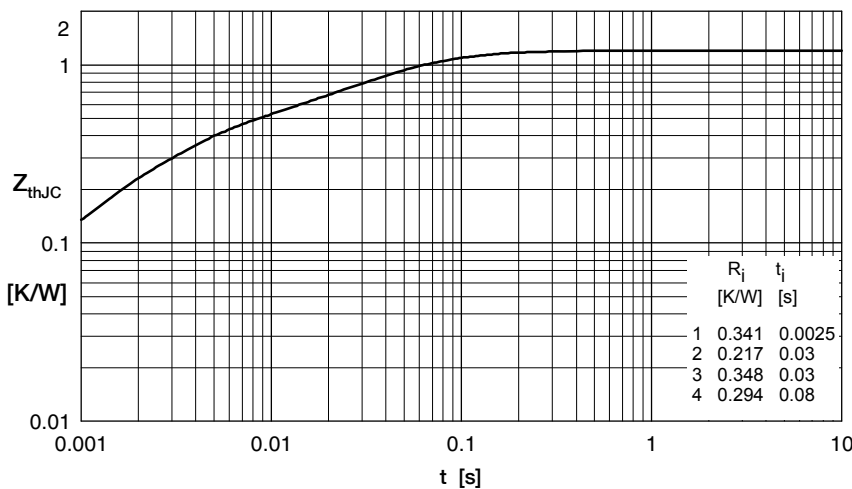

Fig. 7 Transient thermal impedance junction to case

## Inverter IGBT

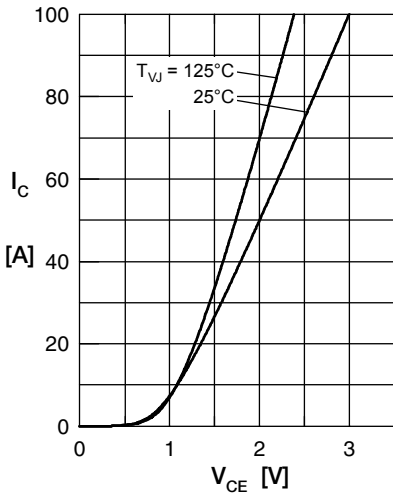

Fig. 1 Typ. output characteristics

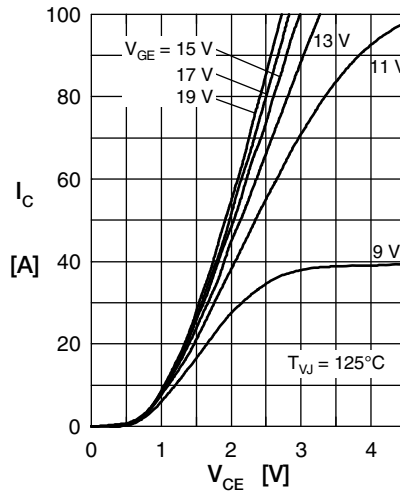

Fig. 2 Typ. output characteristics

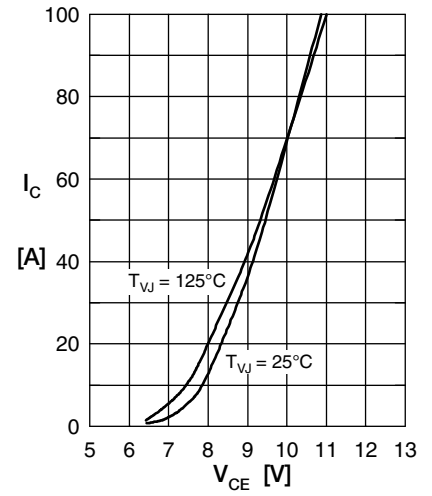

Fig. 3 Typ. transfer characteristics

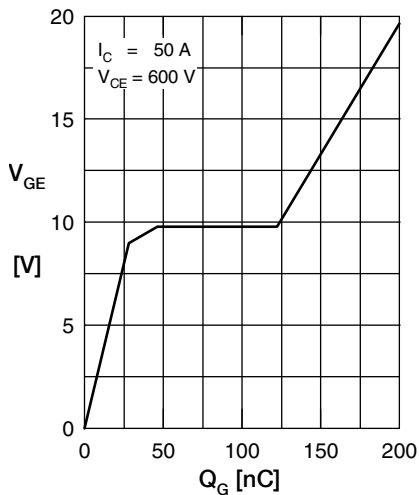

Fig. 4 Dynamic parameters  
 $Q_r, I_{RM}$  versus  $T_{VJ}$

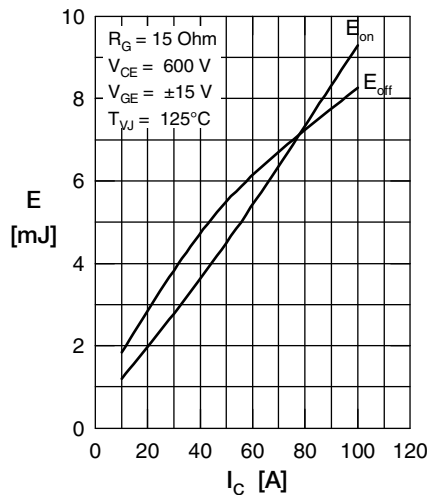

Fig. 5 Typ. recovery time  
 $t_{tr}$  versus  $-di_F/dt$

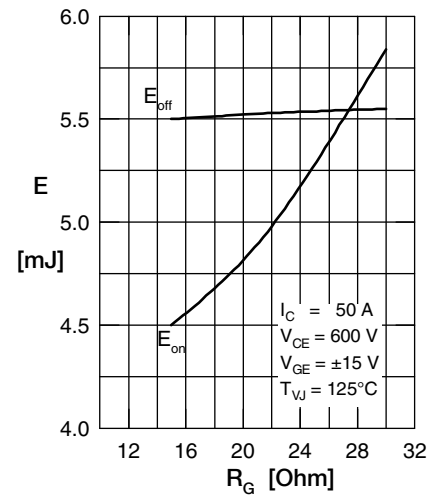

Fig. 6 Typ. peak forward voltage  
 $V_{FR}$  and  $t_{tr}$  versus  $di_F/dt$

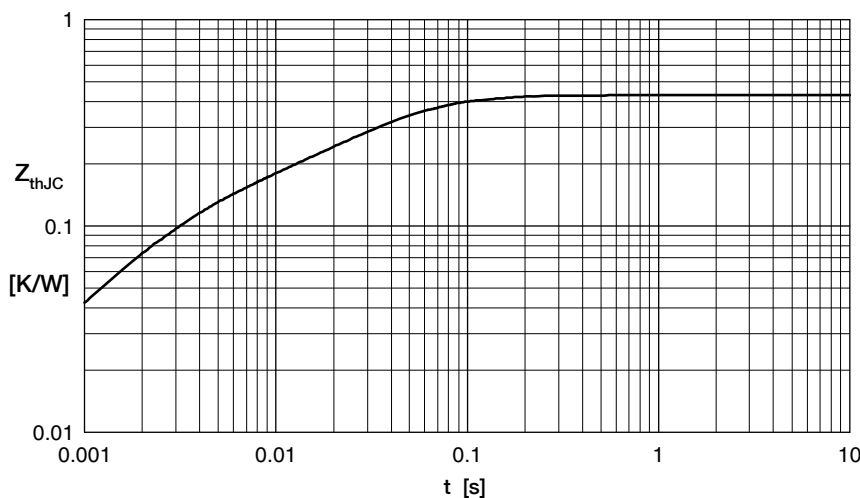

Fig. 7 Transient thermal impedance junction to case

## Inverter Diode

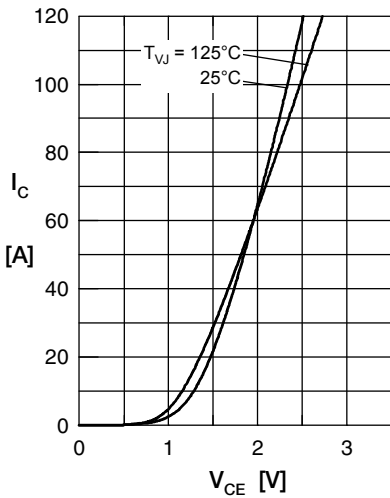

Fig. 1 Typ. Forward current versus  $V_F$

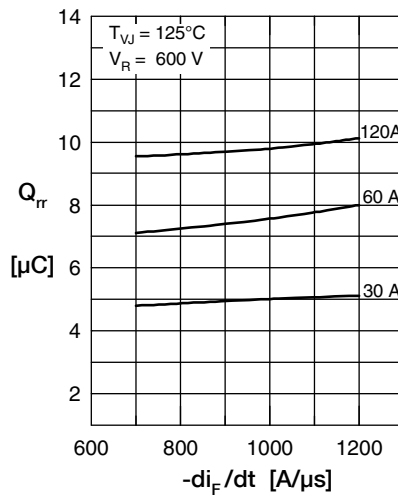

Fig. 2 Typ. reverse recovery charge  $Q_{rr}$  versus  $di/dt$

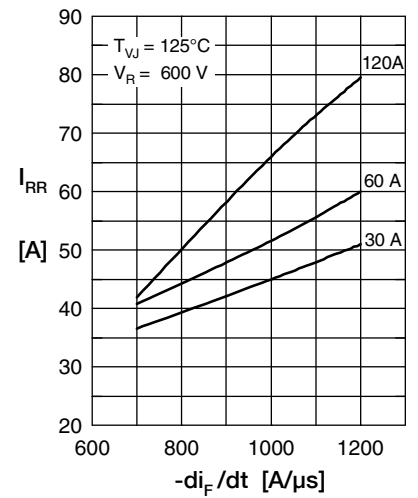

Fig. 3 Typ. peak reverse current  $I_{RM}$  versus  $di/dt$

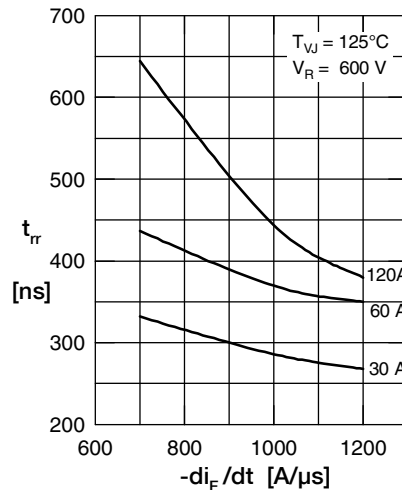

Fig. 4 Dynamic parameters  $Q_{rr}$ ,  $I_{RM}$  versus  $T_{VJ}$

Fig. 5 Typ. recovery time  $t_{rr}$  versus  $-di_F/dt$

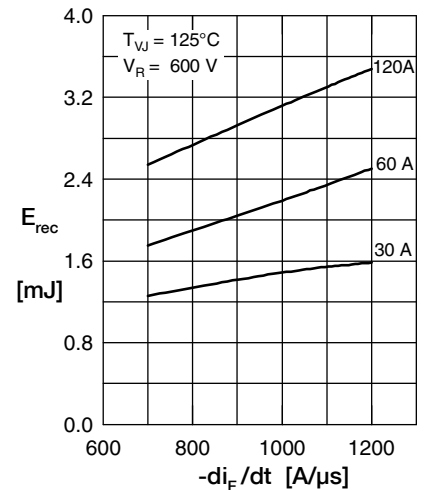

Fig. 6 Typ. recovery energy  $E_{rec}$  versus  $-di/dt$

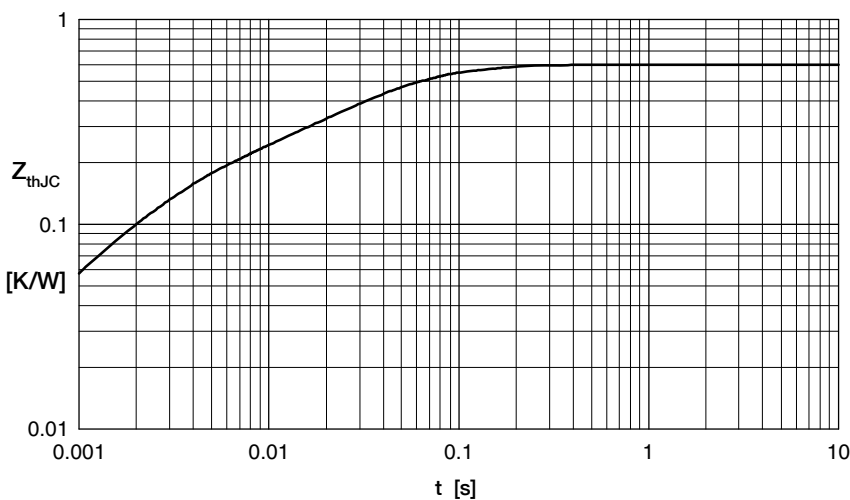

Fig. 7 Transient thermal impedance junction to case