

# FRED Module

$V_{RRM} = 600\text{ V}$   
 $I_{FAV} = 95\text{ A}$   
 $t_{rr} = 110\text{ ns}$

## Fast Recovery Epitaxial Diode

### Part number

MEA 95-06DA

MEK 95-06DA

MEE 95-06DA

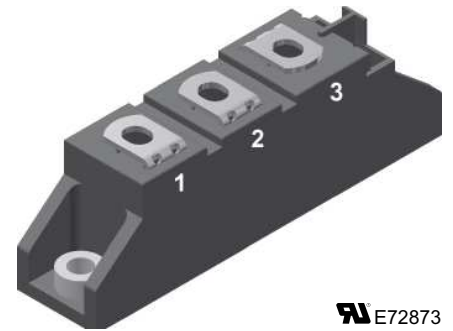

 E72873

Backside: isolated

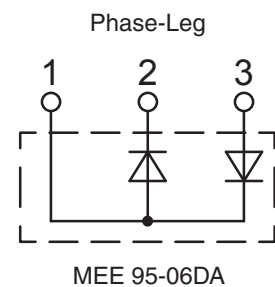
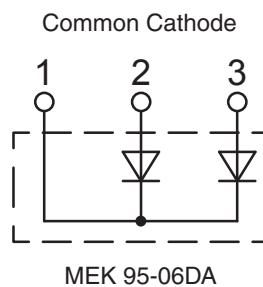
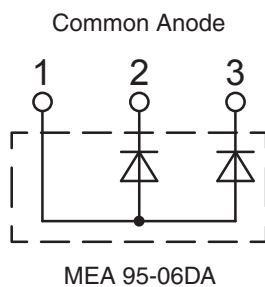

### Features / Advantages:

- Planar passivated chips
- Low switching losses
- Soft recovery behaviour
- High reliability circuit operation
- Low voltage peaks for reduced protection circuits
- Low noise switching
- Low losses

### Applications:

- Antiparallel diode for high frequency switching devices
- Free wheeling diode in converters and motor control circuits
- Inductive heating and melting
- Uninterruptible power supplies (UPS)
- Ultrasonic cleaners and welders

### Package: TO-240AA

- Isolation voltage: 4800 V~
- Industry standard outline
- RoHS compliant
- Height: 30 mm
- Base plate: DCB ceramic
- Reduced weight
- Advanced power cycling

### Disclaimer Notice

Information furnished is believed to be accurate and reliable. However, users should independently evaluate the suitability of and test each product selected for their own applications. Littelfuse products are not designed for, and may not be used in, all applications. Read complete Disclaimer Notice at [www.littelfuse.com/disclaimer-electronics](http://www.littelfuse.com/disclaimer-electronics).

| Diode       |  |   |                         | Ratings |      |                  |    |
|-------------|--|---|-------------------------|---------|------|------------------|----|
| Symbol      | Definitions                                  | Conditions  | min.                    | typ.    | max. |                  |    |
| $V_{RSM}$   | max. non-repetitive reverse blocking voltage |   | $T_{VJ} = 25^{\circ}C$  |         | 600  | V                |    |
| $V_{RRM}$   | max. repetitive reverse blocking voltage     |   | $T_{VJ} = 25^{\circ}C$  |         | 600  | V                |    |
| $I_R$       | reverse current                              | $V_R = V_{RRM}$                                     | $T_{VJ} = 25^{\circ}C$  |         | 2    | mA               |    |
|             |  | $V_R = 0.8 \cdot V_{RRM}$                           | $T_{VJ} = 25^{\circ}C$  |         | 0.5  | mA               |    |
|             |  | $V_R = 0.8 \cdot V_{RRM}$                           | $T_{VJ} = 125^{\circ}C$ |         | 34   | mA               |    |
| $V_F$       | forward voltage                              | $I_F = 100 A$                                       | $T_{VJ} = 25^{\circ}C$  |         | 1.55 | V                |    |
|             |  |   | $T_{VJ} = 125^{\circ}C$ |         | 1.36 | V                |    |
|             |  | $I_F = 300 A$                                       | $T_{VJ} = 25^{\circ}C$  |         | 2.09 | V                |    |
|             |  |   | $T_{VJ} = 125^{\circ}C$ |         | 2.05 | V                |    |
| $I_{FRMS}$  | RMS forward current                          |   | $T_C = 75^{\circ}C$     |         | 142  | A                |    |
| $I_{FAV}$ ① | average forward current                      | $T_C = 75^{\circ}C$<br>rectangular, d = 0.5         | $T_{VJ} = 150^{\circ}C$ |         | 95   | A                |    |
| $V_{TO}$    | threshold voltage                            | for power-loss calculations only                    | $T_{VJ} = T_{VJM}$      |         | 1.01 | V                |    |
| $r_T$       | slope resistance                             |   |                         |         | 2.85 | m $\Omega$       |    |
| $R_{thJC}$  | thermal resistance junction to case          |   |                         | 0.10    | 0.45 | K/W              |    |
| $R_{thCH}$  | thermal resistance junction to heatsink      |   |                         |         |      | K/W              |    |
| $P_{tot}$   |  |   | $T_C = 25^{\circ}C$     |         | 280  | W                |    |
| $I_{FSM}$   | max. surge forward current                   | t = 10 ms (50 Hz), sine<br>t = 8.3 ms (60 Hz), sine | $T_{VJ} = 45^{\circ}C$  |         | 1200 | A                |    |
|             |  |   |                         |         | 1300 | A                |    |
|             |  | t = 10 ms (50 Hz), sine<br>t = 8.3 ms (60 Hz), sine | $T_{VJ} = 150^{\circ}C$ |         | 1080 | A                |    |
|             |  |   |                         |         | 1170 | A                |    |
| $I^2t$      | $I^2t$ value for fusing                      | t = 10 ms (50 Hz), sine<br>t = 8.3 ms (60 Hz), sine | $T_{VJ} = 45^{\circ}C$  |         | 7200 | A <sup>2</sup> s |    |
|             |  |   |                         |         | 7100 | A <sup>2</sup> s |    |
|             |  | t = 10 ms (50 Hz), sine<br>t = 8.3 ms (60 Hz), sine | $T_{VJ} = 150^{\circ}C$ |         | 5800 | A <sup>2</sup> s |    |
|             |  |   |                         |         | 5700 | A <sup>2</sup> s |    |
| $t_{rr}$    | max. reverse recovery current                | $I_F = 95 A; V_R = 300 V$                           | $T_{VJ} = 25^{\circ}C$  |         | 55   | 100              | ns |
|             |  |   | $T_{VJ} = 100^{\circ}C$ |         | 110  | 150              | ns |
| $I_{RM}$    | reverse recovery time                        | -di/dt = 400 A/ $\mu$ s; L $\leq$ 0.05 $\mu$ H      | $T_{VJ} = 25^{\circ}C$  |         | 11   | 15               | A  |
|             |  |   | $T_{VJ} = 100^{\circ}C$ |         | 21   | 25               | A  |

①  $I_{FAVM}$  rating includes reverse blocking losses at  $T_{VJM}$ ,  $V_R = 0.8 V_{RRM}$ , duty cycle d = 0.5



| Package TO-240AA |  |                      | Ratings                             |      |      |    |
|------------------|--|----------------------|-------------------------------------|------|------|----|
| Symbol           | Definitions  | Conditions           | min.                                | typ. | max. |    |
| $I_{RMS}$        | RMS current  | per terminal         |                                     |      | 200  | A  |
| $T_{VJ}$         | virtual junction temperature                                 |                      | -40                                 |      | 150  | °C |
| $T_{op}$         | operation temperature  |                      | -40                                 |      | 125  | °C |
| $T_{stg}$        | storage temperature  |                      | -40                                 |      | 125  | °C |
| <b>Weight</b>    |  |                      |                                     | 76   |      | g  |
| $M_D$            | mounting torque  |                      | 2.5                                 |      | 4    | Nm |
| $M_T$            | terminal torque  |                      | 2.5                                 |      | 4    | Nm |
| $d_{Spp/App}$    | creepage distance on surface   striking distance through air | terminal to terminal | 13.0                                | 9.7  |      | mm |
| $d_{Spb/Appb}$   |  | terminal to backside | 16.0                                | 16.0 |      | mm |
| $V_{ISOL}$       | isolation voltage  | t = 1 second         | 50/60 Hz, RMS; $I_{ISOL} \leq 1$ mA |      | 4800 | V  |
|                  |  | t = 1 minute         |                                     |      | 4000 | V  |

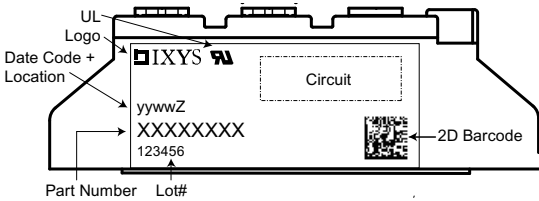

| Ordering | Part Name   | Marking on Product | Delivering Mode | Base Qty | Ordering Code |
|----------|-------------|--------------------|-----------------|----------|---------------|
| Standard | MEA 95-06DA | MEA 95-06DA        | Box             | 36       | 467286        |
| Standard | MEK 95-06DA | MEK 95-06DA        | Box             | 36       | 466492        |
| Standard | MEE 95-06DA | MEE 95-06DA        | Box             | 36       | 468568        |

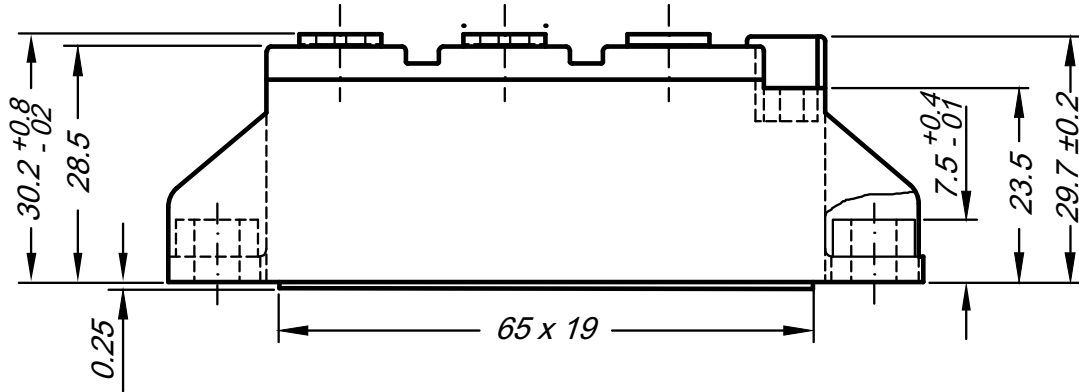
**Outlines TO-240AA**

General tolerance: DIN ISO 2768 class „c“

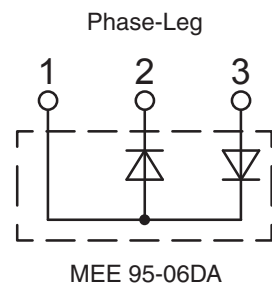
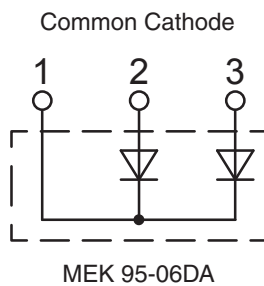
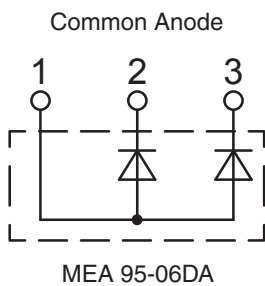
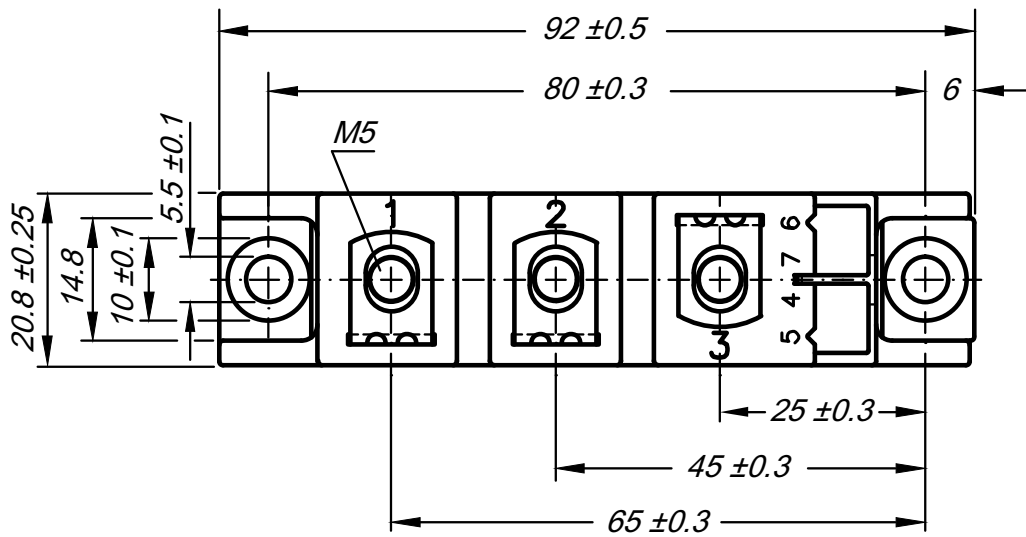

**Curves**

 Fig. 1 Typ. forward current  $I_F$  vs. voltage drop  $V_T$  per leg

 Fig. 2 Typ. reverse recovery charge  $Q_r$  versus  $-di_F/dt$ 

 Fig. 3 Typ. peak reverse current  $I_{RM}$  versus  $-di_F/dt$ 

 Fig. 4 Typ. dynamic parameters  $Q_r$ ,  $I_{RM}$  vs. junction temperature  $T_{VJ}$ 

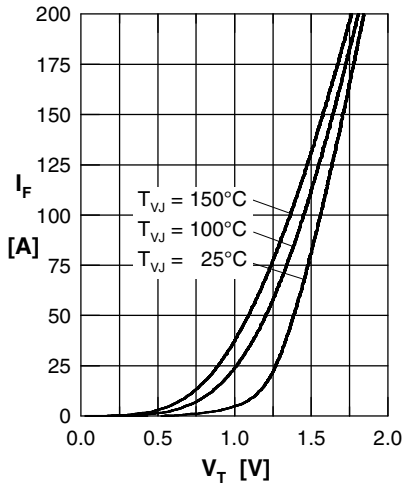
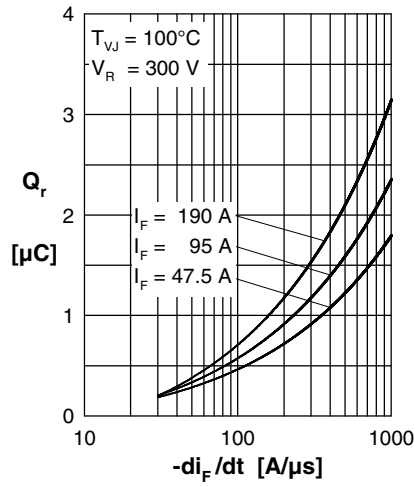
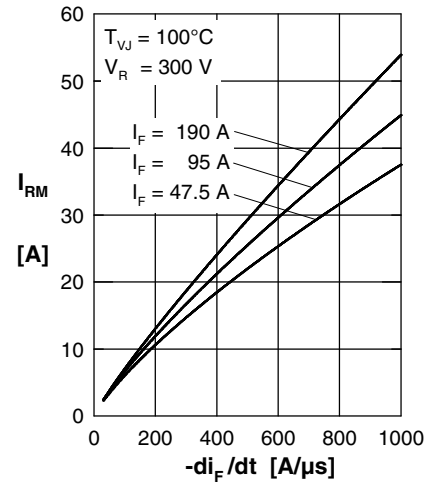
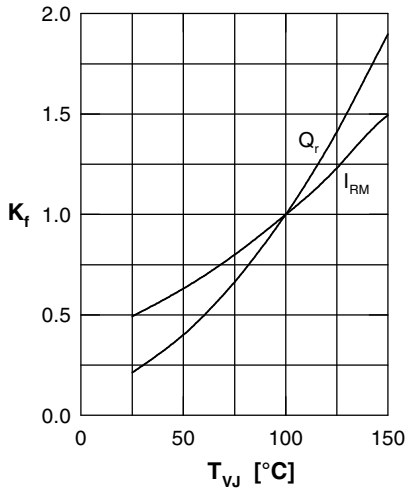
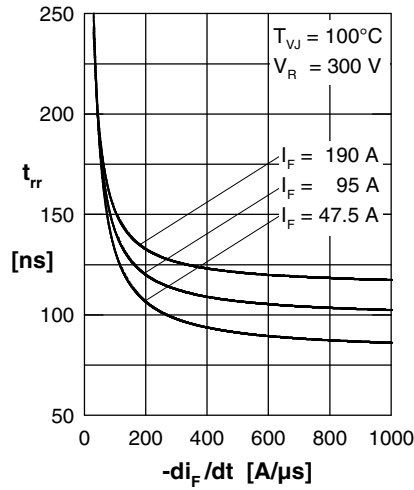
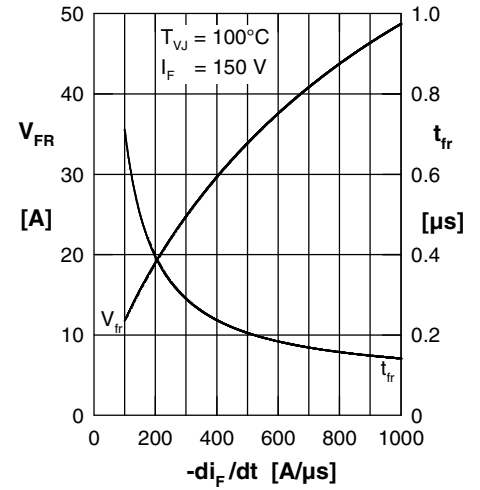
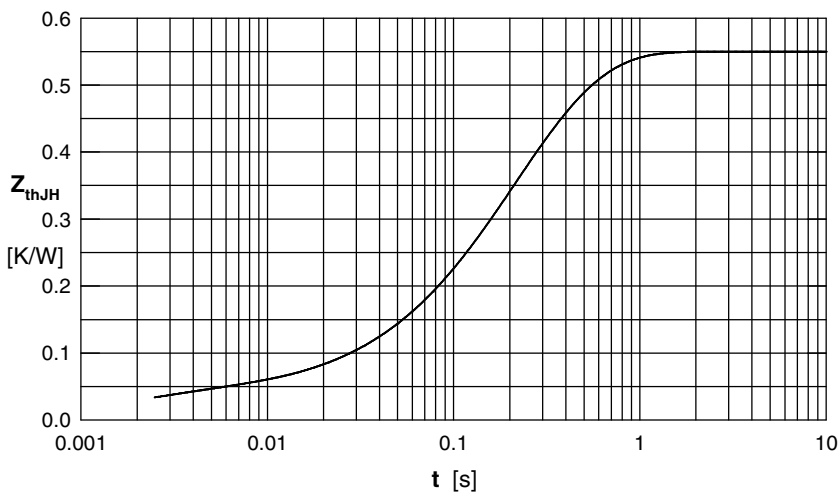
 Fig. 5 Typ. recovery time  $t_{tr}$  vs.  $-di_F/dt$ 

 Fig. 6 Typ. peak forward voltage  $V_{FR}$  and  $t_{tr}$  versus  $di_F/dt$ 

Fig. 7 Typ. transient thermal impedance junction to heatsink

| i | $R_{thi}$ (K/W) | $t_i$ (s) |
|---|-----------------|-----------|
| 1 | 0.037           | 0.002     |
| 2 | 0.138           | 0.134     |
| 3 | 0.093           | 0.250     |
| 4 | 0.282           | 0.274     |