

# FRED Module

 $V_{RRM} = 1200\text{ V}$   
 $I_{FAV} = 75\text{ A}$   
 $t_{rr} = 230\text{ ns}$ 

## Fast Recovery Epitaxial Diode

### Part number

MEA 75-12DA

MEK 75-12DA

MEE 75-12DA

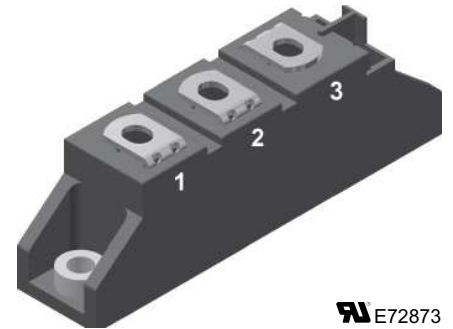
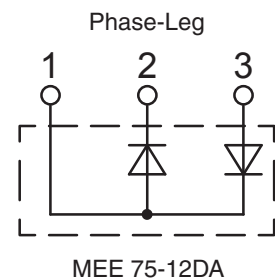
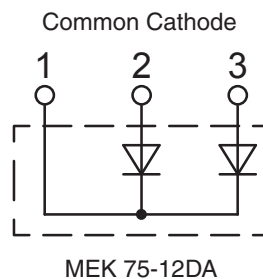
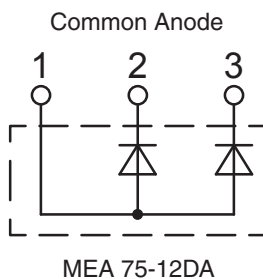
 E72873  
 Backside: isolated

### Features / Advantages:

- Planar passivated chips
- Low switching losses
- Soft recovery behaviour
- High reliability circuit operation
- Low voltage peaks for reduced protection circuits
- Low noise switching
- Low losses

### Applications:

- Antiparallel diode for high frequency switching devices
- Free wheeling diode in converters and motor control circuits
- Inductive heating and melting
- Uninterruptible power supplies (UPS)
- Ultrasonic cleaners and welders

### Package: TO-240AA

- Isolation voltage: 4800 V~
- Industry standard outline
- RoHS compliant
- Height: 30 mm
- Base plate: DCB ceramic
- Reduced weight
- Advanced power cycling

### Disclaimer Notice

Information furnished is believed to be accurate and reliable. However, users should independently evaluate the suitability of and test each product selected for their own applications. Littelfuse products are not designed for, and may not be used in, all applications. Read complete Disclaimer Notice at [www.littelfuse.com/disclaimer-electronics](http://www.littelfuse.com/disclaimer-electronics).

Diode				Ratings			
Symbol	Definitions	Conditions	min.	typ.	max.		
$V_{RSM}$	max. non-repetitive reverse blocking voltage		$T_{VJ} = 25^{\circ}C$			1200	V
$V_{RRM}$	max. repetitive reverse blocking voltage		$T_{VJ} = 25^{\circ}C$			1200	V
$I_R$	reverse current	$V_R = V_{RRM}$ $V_R = 0.8 \cdot V_{RRM}$ $V_R = 0.8 \cdot V_{RRM}$	$T_{VJ} = 25^{\circ}C$			2	mA
			$T_{VJ} = 25^{\circ}C$			0.5	mA
			$T_{VJ} = 125^{\circ}C$			34	mA
$V_F$	forward voltage	$I_F = 100 A$	$T_{VJ} = 25^{\circ}C$			2.17	V
			$T_{VJ} = 125^{\circ}C$			1.85	V
			$T_{VJ} = 25^{\circ}C$			2.64	V
			$T_{VJ} = 125^{\circ}C$			2.58	V
$I_{FRMS}$	RMS forward current		$T_C = 75^{\circ}C$			107	A
$I_{FAV}$ ①	average forward current	$T_C = 75^{\circ}C$ rectangular, d = 0.5	$T_{VJ} = 150^{\circ}C$			75	A
$V_{TO}$	threshold voltage	for power-loss calculations only	$T_{VJ} = T_{VJM}$			1.48	V
$r_T$	slope resistance					3.65	m $\Omega$
$R_{thJC}$	thermal resistance junction to case					0.45	K/W
$R_{thCH}$	thermal resistance junction to heatsink				0.10		K/W
$P_{tot}$			$T_C = 25^{\circ}C$			280	W
$I_{FSM}$	max. surge forward current	t = 10 ms (50 Hz), sine t = 8.3 ms (60 Hz), sine t = 10 ms (50 Hz), sine t = 8.3 ms (60 Hz), sine	$T_{VJ} = 45^{\circ}C$			1200	A
						1300	A
			$T_{VJ} = 150^{\circ}C$			1080	A
						1170	A
$I^2t$	$I^2t$ value for fusing	t = 10 ms (50 Hz), sine t = 8.3 ms (60 Hz), sine t = 10 ms (50 Hz), sine t = 8.3 ms (60 Hz), sine	$T_{VJ} = 45^{\circ}C$			7200	A <sup>2</sup> s
						7100	A <sup>2</sup> s
			$T_{VJ} = 150^{\circ}C$			5800	A <sup>2</sup> s
						5700	A <sup>2</sup> s
$t_{rr}$	max. reverse recovery current	$I_F = 70 A; V_R = 600 V$	$T_{VJ} = 25^{\circ}C$			140	ns
			$T_{VJ} = 100^{\circ}C$			230	ns
$I_{RM}$	reverse recovery time	-di/dt = 400 A/ $\mu$ s; L $\leq$ 0.05 $\mu$ H	$T_{VJ} = 25^{\circ}C$			25	A
			$T_{VJ} = 100^{\circ}C$			33	A

①  $I_{FAVM}$  rating includes reverse blocking losses at  $T_{VJM}$ ,  $V_R = 0.8 V_{RRM}$ , duty cycle d = 0.5



Package TO-240AA			Ratings			
Symbol	Definitions	Conditions	min.	typ.	max.	
$I_{RMS}$	RMS current	per terminal			200	A
$T_{VJ}$	virtual junction temperature		-40		150	°C
$T_{op}$	operation temperature		-40		125	°C
$T_{stg}$	storage temperature		-40		125	°C
<b>Weight</b>				76		g
$M_D$	mounting torque		2.5		4	Nm
$M_T$	terminal torque		2.5		4	Nm
$d_{Spp/App}$	creepage distance on surface   striking distance through air	terminal to terminal	13.0	9.7		mm
$d_{Spb/Apb}$		terminal to backside	16.0	16.0		mm
$V_{ISOL}$	isolation voltage	t = 1 second	50/60 Hz, RMS; $I_{ISOL} \leq 1$ mA		4800	V
		t = 1 minute			4000	V

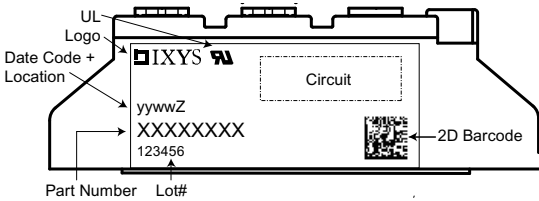

Ordering	Part Name	Marking on Product	Delivering Mode	Base Qty	Ordering Code
Standard	MEA 75-12DA	MEA 75-12DA	Box	36	469130
Standard	MEK 75-12DA	MEK 75-12DA	Box	36	468541
Standard	MEE 75-12DA	MEE 75-12DA	Box	36	469297

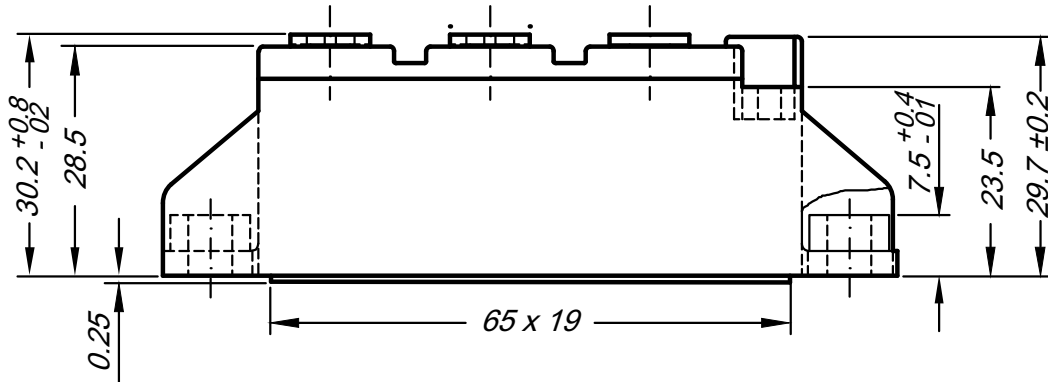
**Outlines TO-240AA**

General tolerance: DIN ISO 2768 class „c“

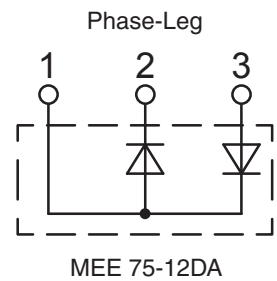
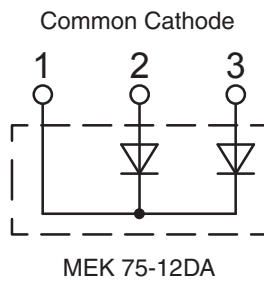
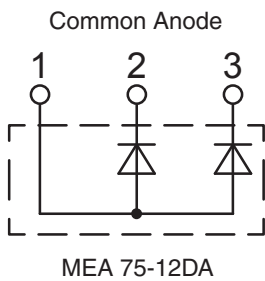
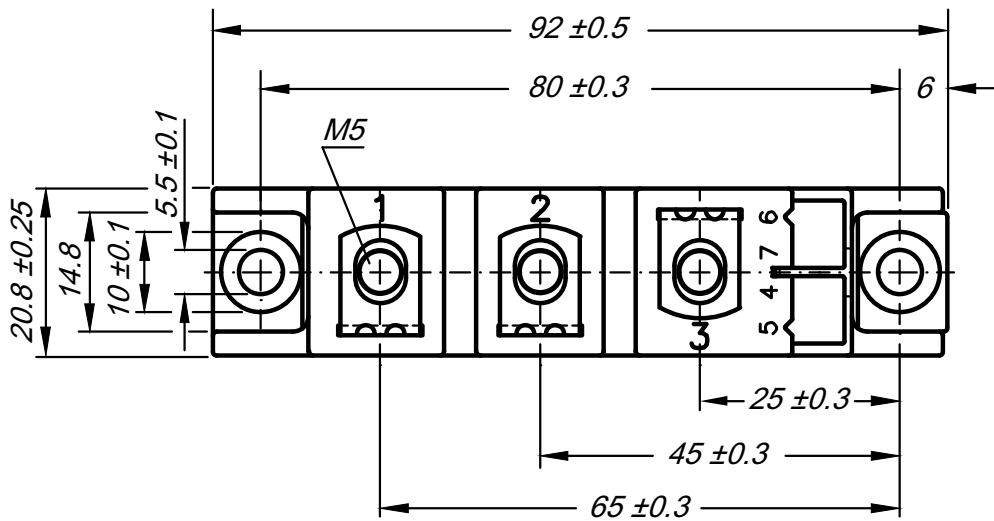

**Curves**

 Fig. 1 Typ. forward current  $I_F$  vs. voltage drop  $V_F$  per leg

 Fig. 2 Typ. reverse recovery charge  $Q_r$  versus  $-di_F/dt$ 

 Fig. 3 Typ. peak reverse current  $I_{RM}$  versus  $-di_F/dt$ 

 Fig. 4 Typ. dynamic parameters  $Q_r$ ,  $I_{RM}$  vs. junction temperature  $T_{VJ}$ 

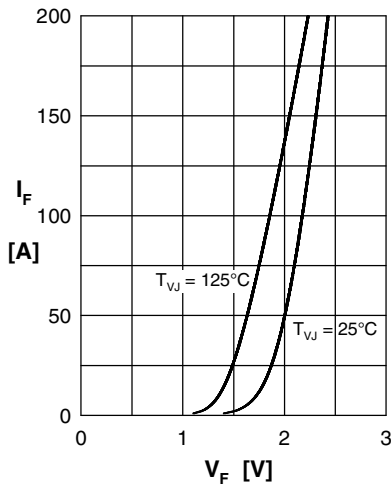
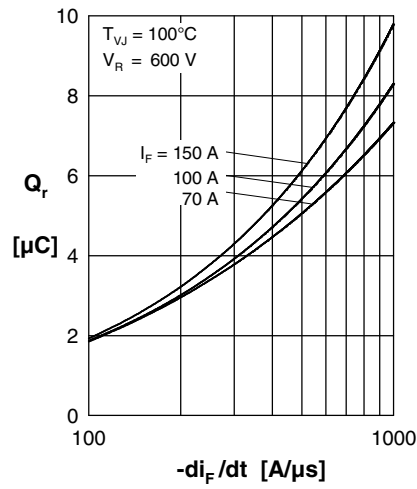
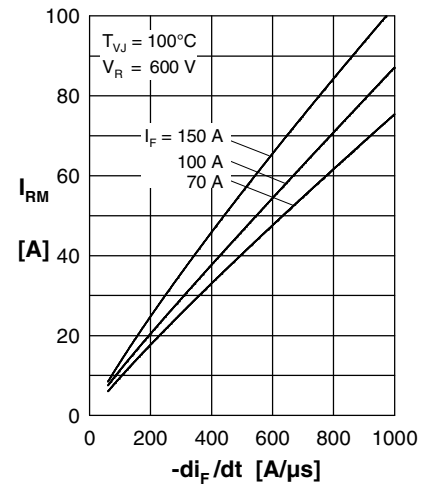
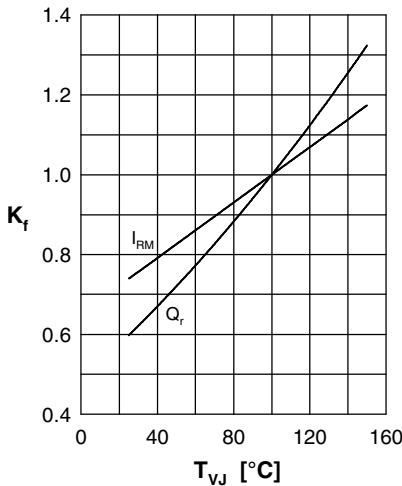
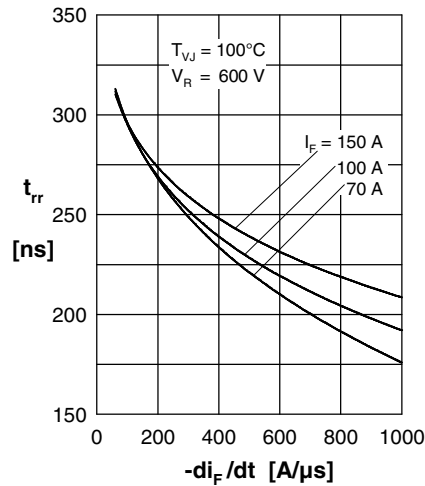
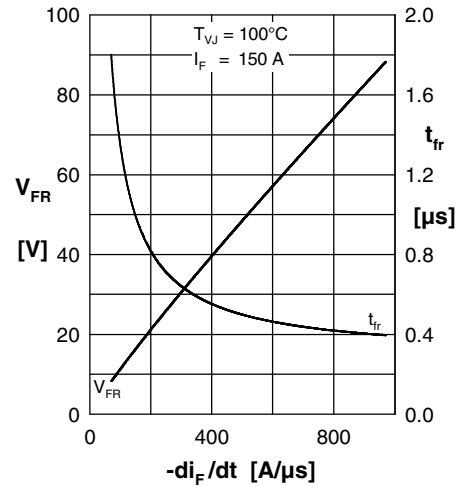
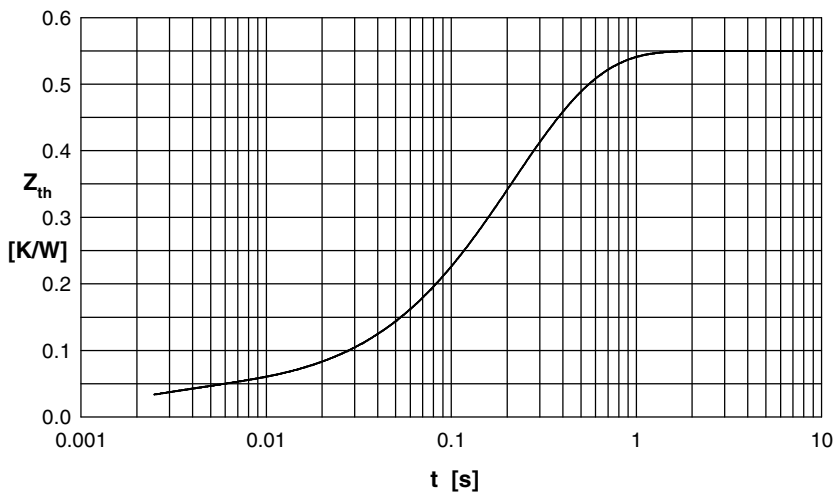
 Fig. 5 Typ. recovery time  $t_{rr}$  versus  $-di_F/dt$ 

 Fig. 6 Typ. peak forward voltage  $V_{FR}$  and  $t_{fr}$  versus  $-di_F/dt$ 

Fig. 7 Typ. transient thermal impedance junction to heatsink

 Constants for  $Z_{thJS}$  calculation:

i	$R_{thi}$ (K/W)	$t_i$ (s)
1	0.037	0.002
2	0.138	0.134
3	0.093	0.250
4	0.282	0.274