

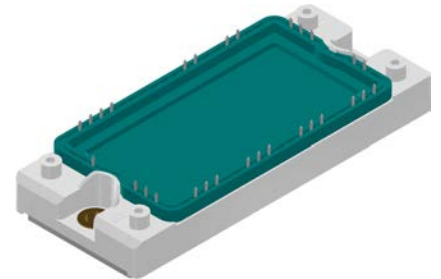
High Voltage Standard Rectifier Module

3~ Rectifier	Brake Chopper
$V_{RRM} = 2200\text{ V}$	$V_{CES} = 1700\text{ V}$
$I_{DAV} = 210\text{ A}$	$I_{C25} = 145\text{ A}$
$I_{FSM} = 1000\text{ A}$	$V_{CE(sat)} = 1,8\text{ V}$

3~ Rectifier Bridge + Brake Unit + NTC

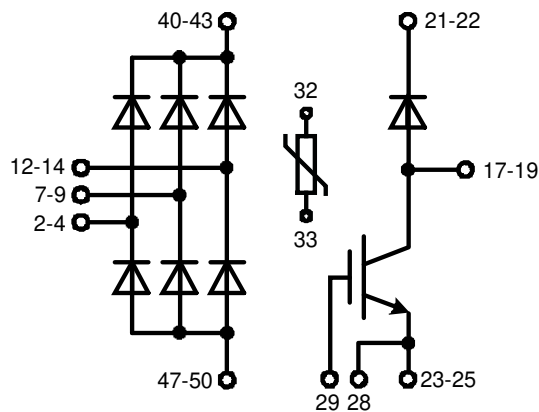
Part number

MDNA210UB2200TED



Backside: isolated

 E72873



Features / Advantages:

- Brake with Infineon IGBT³

Applications:

- 3~ Rectifier with brake unit for drive inverters

Package: E2-Pack

- Isolation Voltage: 4300 V~
- Industry standard outline
- RoHS compliant
- Soldering pins for PCB mounting
- Height: 17 mm
- Base plate: Copper internally DCB isolated
- Advanced power cycling
- Phase Change Material available

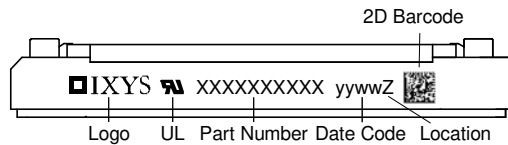
Disclaimer Notice

Information furnished is believed to be accurate and reliable. However, users should independently evaluate the suitability of and test each product selected for their own applications. Littelfuse products are not designed for, and may not be used in, all applications. Read complete Disclaimer Notice at www.littelfuse.com/disclaimer-electronics.

Rectifier				Ratings			
Symbol	Definition	Conditions		min.	typ.	max.	Unit
V_{RSM}	max. non-repetitive reverse blocking voltage					2300	V
V_{RRM}	max. repetitive reverse blocking voltage					2200	V
I_R	reverse current	$V_R = 2200$ V	$T_{VJ} = 25^\circ\text{C}$			100	μA
		$V_R = 2200$ V	$T_{VJ} = 150^\circ\text{C}$			2	mA
V_F	forward voltage drop	$I_F = 70$ A	$T_{VJ} = 25^\circ\text{C}$			1,23	V
		$I_F = 210$ A				1,75	V
		$I_F = 70$ A	$T_{VJ} = 125^\circ\text{C}$			1,19	V
		$I_F = 210$ A				1,67	V
I_{DAV}	bridge output current	$T_C = 85^\circ\text{C}$ rectangular	$T_{VJ} = 150^\circ\text{C}$ $d = \frac{1}{3}$			210	A
V_{FO}	threshold voltage	} for power loss calculation only				0,82	V
r_F	slope resistance					5,2	m Ω
R_{thJC}	thermal resistance junction to case					0,5	K/W
R_{thCH}	thermal resistance case to heatsink				0,1		K/W
P_{tot}	total power dissipation			$T_C = 25^\circ\text{C}$		250	W
I_{FSM}	max. forward surge current	$t = 10$ ms; (50 Hz), sine	$T_{VJ} = 45^\circ\text{C}$			1,00	kA
		$t = 8,3$ ms; (60 Hz), sine	$V_R = 0$ V			1,08	kA
		$t = 10$ ms; (50 Hz), sine	$T_{VJ} = 150^\circ\text{C}$			850	A
		$t = 8,3$ ms; (60 Hz), sine	$V_R = 0$ V			920	A
I^2t	value for fusing	$t = 10$ ms; (50 Hz), sine	$T_{VJ} = 45^\circ\text{C}$			5,00	kA ² s
		$t = 8,3$ ms; (60 Hz), sine	$V_R = 0$ V			4,85	kA ² s
		$t = 10$ ms; (50 Hz), sine	$T_{VJ} = 150^\circ\text{C}$			3,62	kA ² s
		$t = 8,3$ ms; (60 Hz), sine	$V_R = 0$ V			3,52	kA ² s
C_J	junction capacitance	$V_R = 400$ V; $f = 1$ MHz	$T_{VJ} = 25^\circ\text{C}$		33		pF

Brake IGBT + Diode				Ratings			
Symbol	Definition	Conditions	min.	typ.	max.	Unit	
V_{CES}	collector emitter voltage	$T_{VJ} = 25^{\circ}C$			1700	V	
V_{GES}	max. DC gate voltage				± 20	V	
V_{GEM}	max. transient gate emitter voltage				± 30	V	
I_{C25}	collector current	$T_C = 25^{\circ}C$			145	A	
I_{C80}		$T_C = 80^{\circ}C$			100	A	
P_{tot}	total power dissipation	$T_C = 25^{\circ}C$			540	W	
$V_{CE(sat)}$	collector emitter saturation voltage	$I_C = 75\text{ A}; V_{GE} = 15\text{ V}$			1,8	V	
					2,1	V	
$V_{GE(th)}$	gate emitter threshold voltage	$I_C = 4\text{ mA}; V_{GE} = V_{CE}$	5,2	5,8	6,4	V	
I_{CES}	collector emitter leakage current	$V_{CE} = V_{CES}; V_{GE} = 0\text{ V}$			0,1	mA	
					0,7	mA	
I_{GES}	gate emitter leakage current	$V_{GE} = \pm 20\text{ V}$			500	nA	
$Q_{G(on)}$	total gate charge	$V_{CE} = 900\text{ V}; V_{GE} = 15\text{ V}; I_C = 75\text{ A}$		1200		nC	
$t_{d(on)}$	turn-on delay time	inductive load $V_{CE} = 900\text{ V}; I_C = 75\text{ A}$ $V_{GE} = \pm 15\text{ V}; R_G = 3,9\ \Omega$	$T_{VJ} = 125^{\circ}C$		320	ns	
t_r	current rise time				50	ns	
$t_{d(off)}$	turn-off delay time				550	ns	
t_f	current fall time				400	ns	
E_{on}	turn-on energy per pulse				15	mJ	
E_{off}	turn-off energy per pulse				18	mJ	
RBSOA	reverse bias safe operating area	$V_{GE} = \pm 15\text{ V}; R_G = 3,9\ \Omega$					
I_{CM}		$V_{CEK} = 1700\text{ V}$			200	A	
SCSOA	short circuit safe operating area	$V_{CEK} = 1700\text{ V}$					
t_{SC}	short circuit duration	$V_{CE} = 900\text{ V}; V_{GE} = \pm 15$			10	μs	
I_{SC}	short circuit current	$R_G = 3,9\ \Omega$; non-repetitive		400		A	
R_{thJC}	thermal resistance junction to case				0,23	K/W	
R_{thCH}	thermal resistance case to heatsink				0,08	K/W	
Brake Diode							
V_{RRM}	max. repetitive reverse voltage	$T_{VJ} = 25^{\circ}C$			1700	V	
I_{F25}	forward current	$T_C = 25^{\circ}C$			81	A	
I_{F80}		$T_C = 80^{\circ}C$			54	A	
V_F	forward voltage	$I_F = 60\text{ A}$			2,20	V	
					2,00	V	
I_R	reverse current	$V_R = V_{RRM}$			0,1	mA	
					1,2	mA	
Q_{rr}	reverse recovery charge	$V_R = 900\text{ V}$ $-di_F/dt = 1600\text{ A}/\mu s$ $I_F = 60\text{ A}; V_{GE} = 0\text{ V}$	$T_{VJ} = 125^{\circ}C$		15	μC	
I_{RM}	max. reverse recovery current				100	A	
t_{rr}	reverse recovery time				550	ns	
E_{rec}	reverse recovery energy				6,5	mJ	
R_{thJC}	thermal resistance junction to case				0,6	K/W	
R_{thCH}	thermal resistance case to heatsink				0,2	K/W	

Package E2-Pack			Ratings			
Symbol	Definition	Conditions	min.	typ.	max.	Unit
I_{RMS}	RMS current	per terminal			30	A
T_{VJ}	virtual junction temperature		-40		150	°C
T_{op}	operation temperature		-40		125	°C
T_{stg}	storage temperature		-40		125	°C
Weight				176		g
M_D	mounting torque		3		6	Nm
$d_{Spp/App}$	creepage distance on surface striking distance through air	terminal to terminal	6,0			mm
$d_{Spb/Apb}$		terminal to backside	12,0			mm
V_{ISOL}	isolation voltage	t = 1 second	4300			V
		t = 1 minute	3600			V


Part description

M = Module
 D = Diode
 N = High Voltage Standard Rectifier
 A = (>= 2000V)
 210 = Current Rating [A]
 UB = 3- Rectifier Bridge + Brake Unit
 2200 = Reverse Voltage [V]
 T = Thermistor \ Temperature sensor
 ED = E2-Pack

Ordering	Ordering Number	Marking on Product	Delivery Mode	Quantity	Code No.
Standard	MDNA210UB2200TED	MDNA210UB2200TED	Box	6	526034

Temperature Sensor NTC

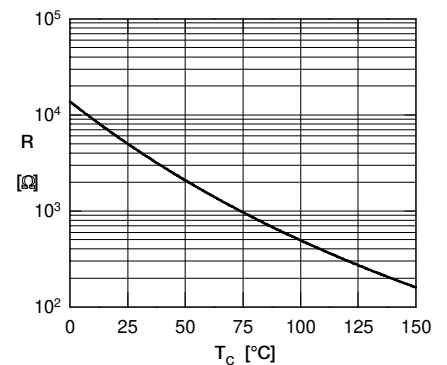
Symbol	Definition	Conditions	min.	typ.	max.	Unit
R_{25}	resistance	$T_{VJ} = 25^\circ$	4,85	5	5,15	k Ω
$B_{25/50}$	temperature coefficient			3375		K

Equivalent Circuits for Simulation

* on die level

 $T_{VJ} = 150^\circ\text{C}$

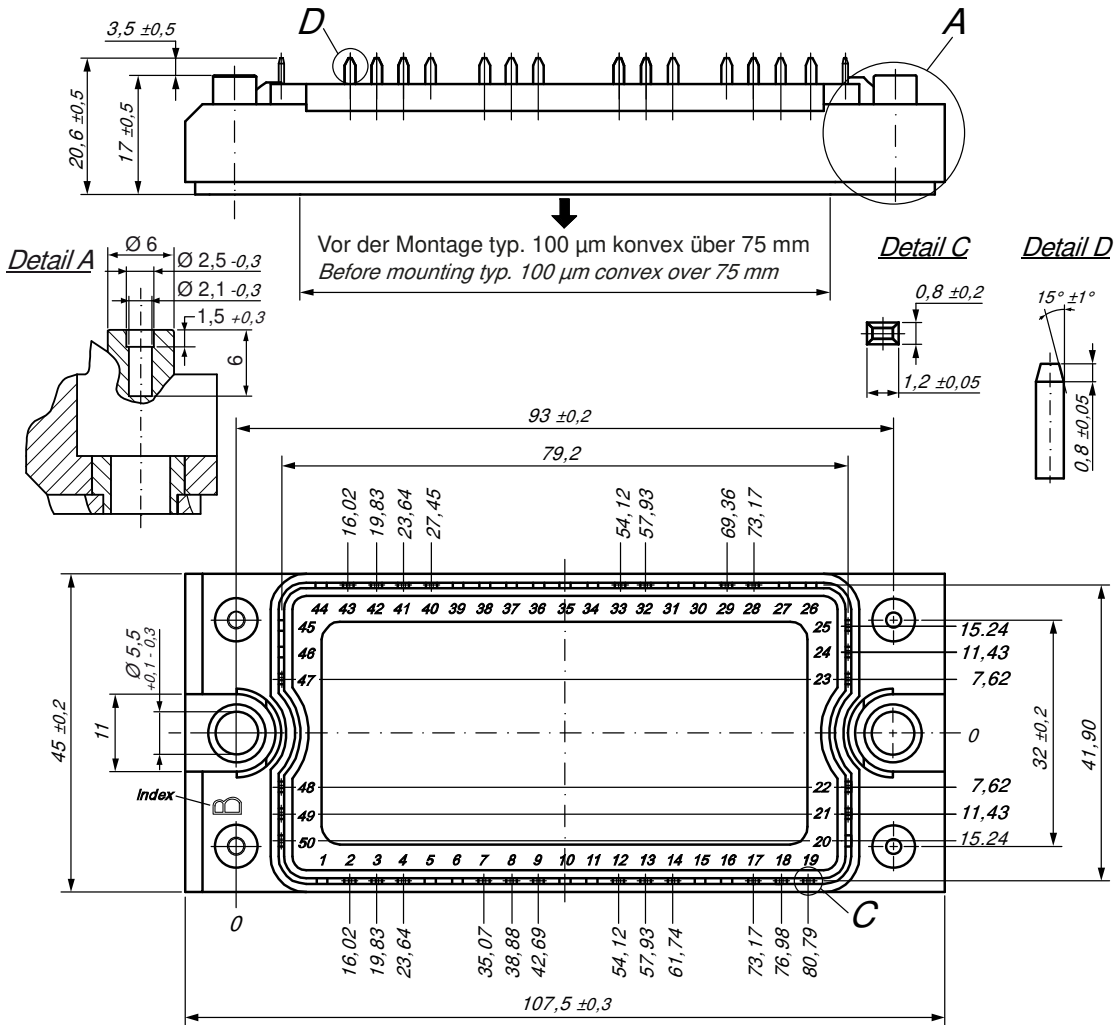
		Rectifier	Brake IGBT +	Brake Diode	
V_0	threshold voltage	0,82	1,1	1,22	V
R_0	slope resistance *	3,1	17,9	13	m Ω



Typ. NTC resistance vs. temperature



Outlines E2-Pack

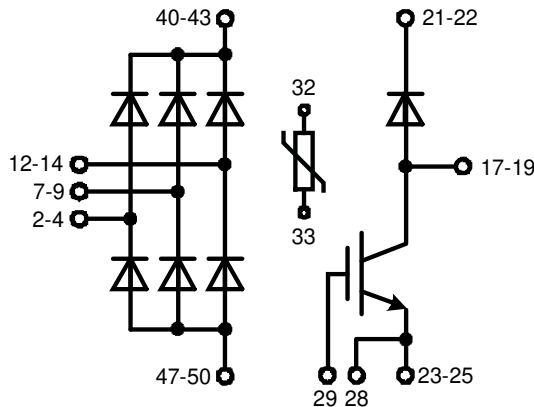


Bemerkung / Note:

- Nichttolerierete Maße nach / Measure without tolerances according DIN ISO 2768-T1-m
- PCB-Lochmuster / PCB hole pattern: **see pin position**
- Toleranz Pin-Position und PCB-Lochmuster / Tolerance of pin position and PCB hole pattern: $\oplus 0.1$
- Montageanleitung / Mounting instruction: www.ixys.com **Application note IXAN0024**

Detail A: PCB-Montage / Mounting on PCB *

- Empfohlene, selbstschneidende Schraube / Recommended, self-tapping screw: **EJOT PT®** (Größe / size: **K25**)
- Max. Schraubenlänge / Max. screw length: **PCB-Dicke / thickness + 6 mm** (max. Lochtiefe / hole depth) *
- Empfohlenes Drehmoment / Recommended mounting torque: **1.5 Nm**



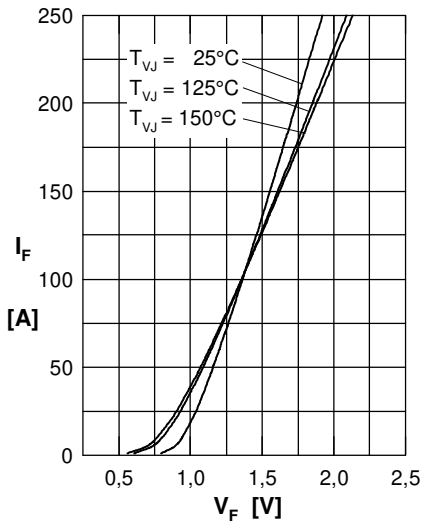
Rectifier


Fig. 1 Forward current versus voltage drop per diode

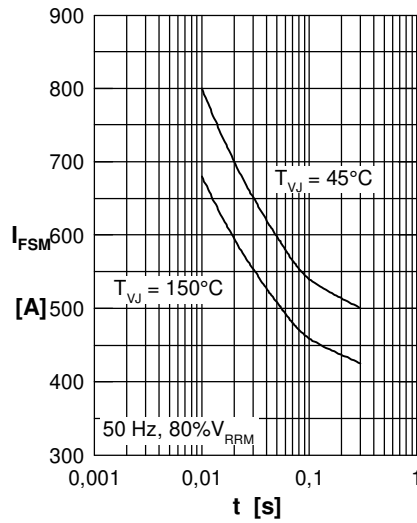


Fig. 2 Surge overload current vs. time per diode

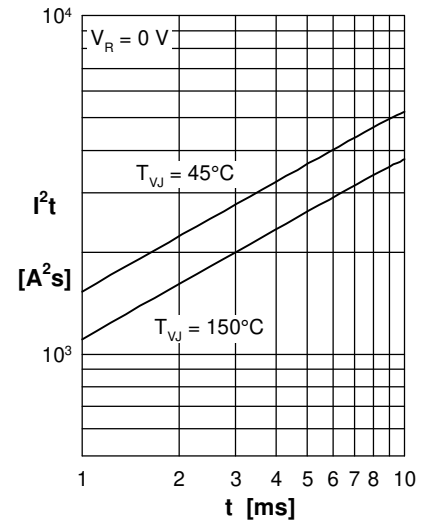
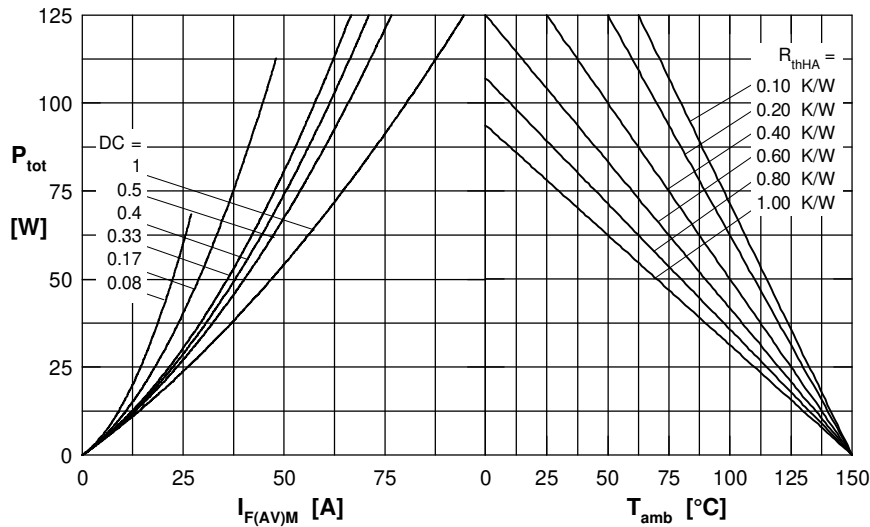

 Fig. 3 I^2t versus time per diode


Fig. 4 Power dissipation vs. forward current and ambient temperature per diode

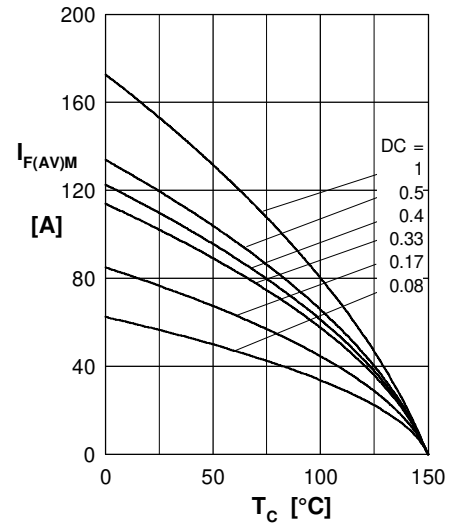


Fig. 5 Max. forward current vs. case temperature per diode

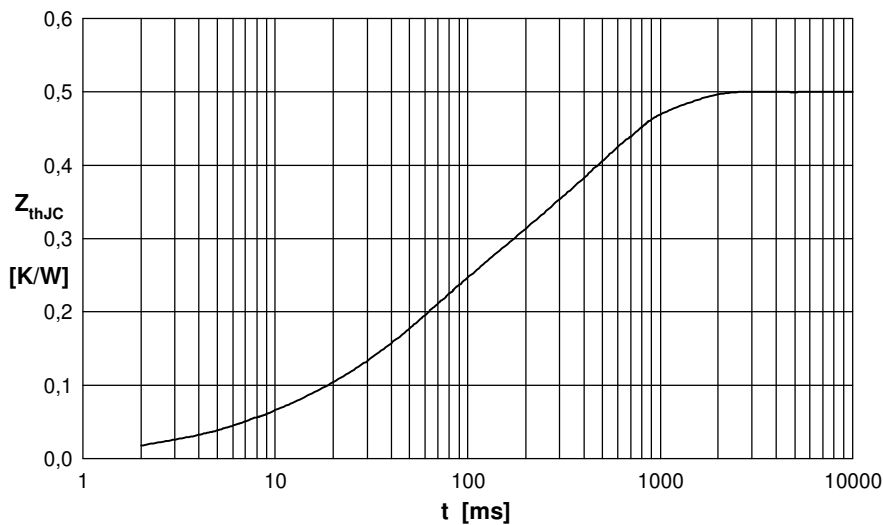


Fig. 6 Transient thermal impedance junction to case vs. time per diode

 Constants for Z_{thJC} calculation:

i	R_{thi} (K/W)	t_i (s)
1	0.030	0.006
2	0.003	0.007
3	0.182	0.045
4	0.285	0.450

Brake IGBT + Diode

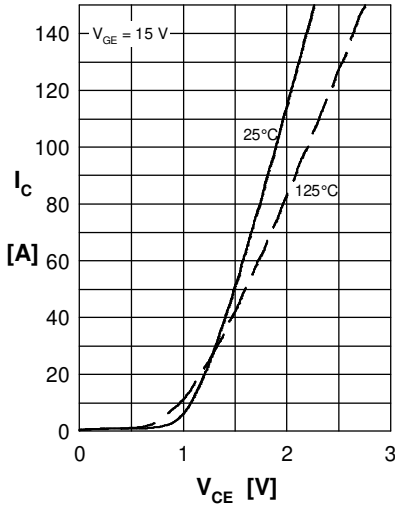


Fig.1 Output characteristics IGBT

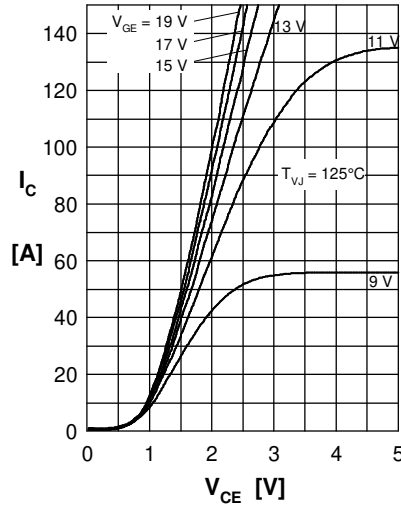


Fig.2 Typ. output characteristics IGBT

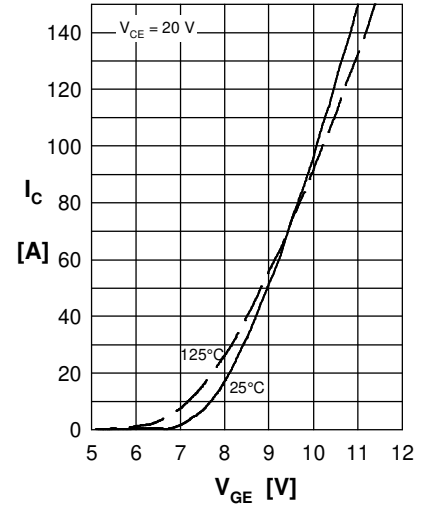


Fig.3 Typ. transfer charact. IGBT

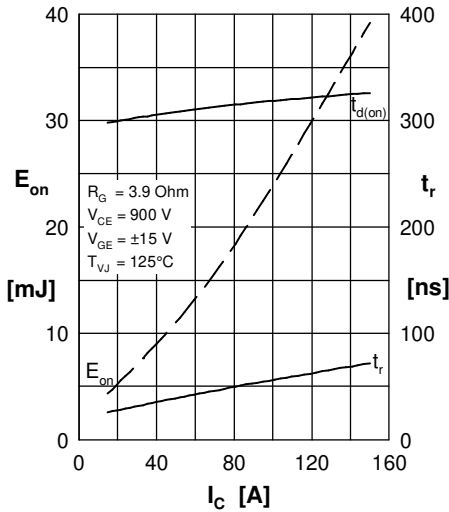


Fig.4 Typ. turn-on energy & switch. times vs. collector current

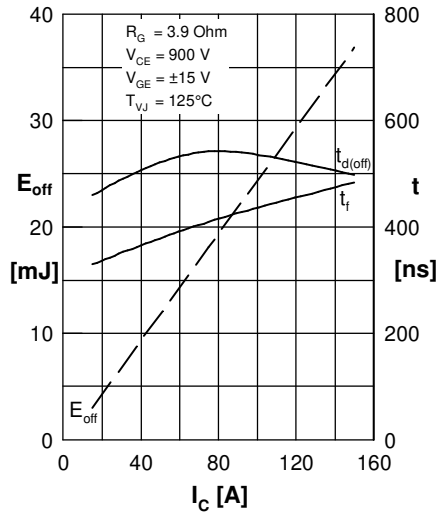


Fig.5 Typ. turn-off energy & switch. times vs. collector current

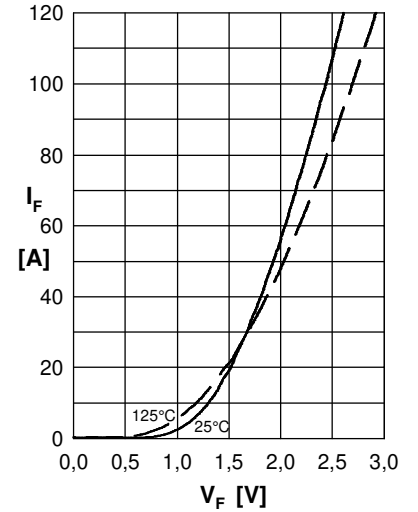


Fig.6 Typ. forward characteristics Diode

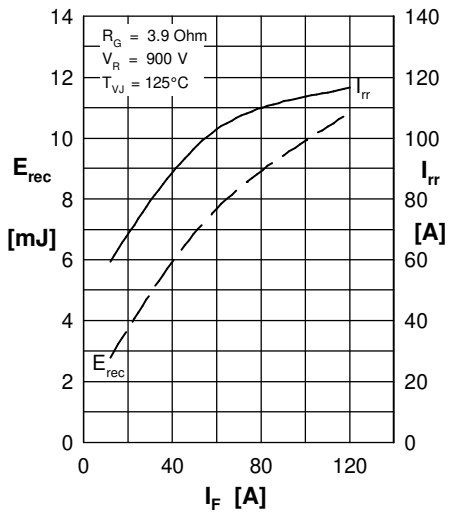


Fig.7 Typ. reverse recovery characteristics Diode

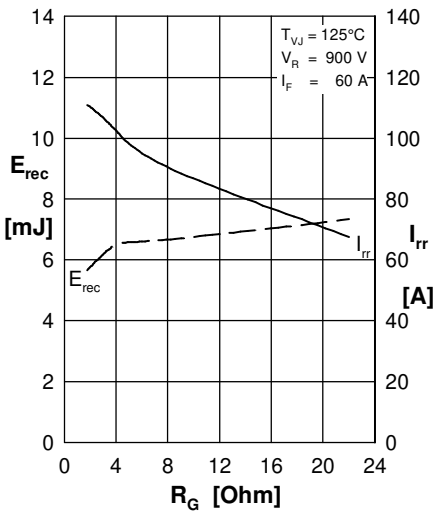


Fig.8 Typ. reverse recovery characteristics Diode

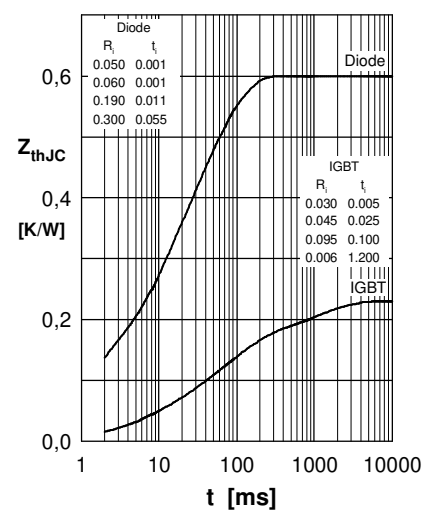


Fig.9 Transient thermal resistance junction to case