

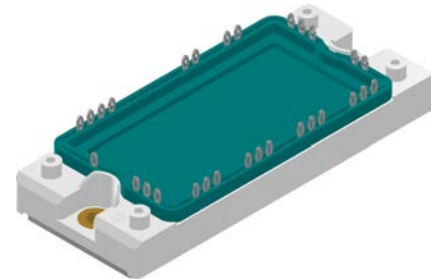
# High Voltage Standard Rectifier Module

3~ Rectifier	Brake Chopper
$V_{RRM} = 2200\text{ V}$	$V_{CES} = 1700\text{ V}$
$I_{DAV} = 210\text{ A}$	$I_{C25} = 145\text{ A}$
$I_{FSM} = 1000\text{ A}$	$V_{CE(sat)} = 1,8\text{ V}$

3~ Rectifier Bridge + Brake Unit + NTC

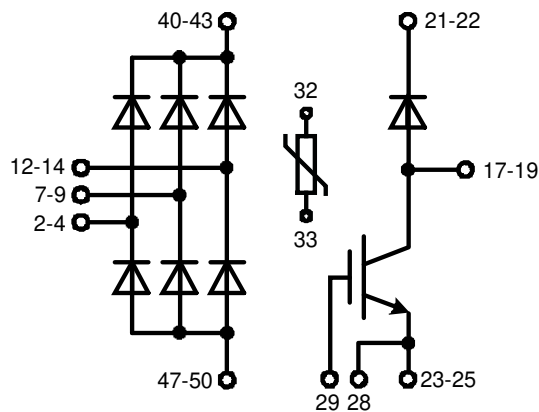
Part number

**MDNA210UB2200PTED**



Backside: isolated

 E72873



## Features / Advantages:

- Brake with Infineon IGBT<sup>3</sup>

## Applications:

- 3~ Rectifier with brake unit for drive inverters

## Package: E2-Pack

- Isolation Voltage: 4300 V~
- Industry standard outline
- RoHS compliant
- PressFit-Pins for PCB mounting
- Height: 17 mm
- Base plate: Copper internally DCB isolated
- Advanced power cycling
- Phase Change Material available

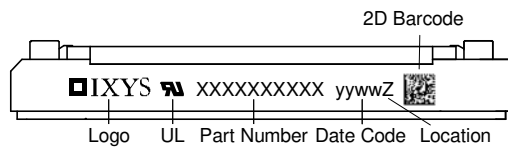
## Disclaimer Notice

Information furnished is believed to be accurate and reliable. However, users should independently evaluate the suitability of and test each product selected for their own applications. Littelfuse products are not designed for, and may not be used in, all applications. Read complete Disclaimer Notice at [www.littelfuse.com/disclaimer-electronics](http://www.littelfuse.com/disclaimer-electronics).

Rectifier				Ratings			
Symbol	Definition	Conditions		min.	typ.	max.	Unit
$V_{RSM}$	max. non-repetitive reverse blocking voltage					2300	V
$V_{RRM}$	max. repetitive reverse blocking voltage					2200	V
$I_R$	reverse current	$V_R = 2200\text{ V}$		$T_{VJ} = 25^\circ\text{C}$		100	$\mu\text{A}$
		$V_R = 2200\text{ V}$		$T_{VJ} = 150^\circ\text{C}$		2	mA
$V_F$	forward voltage drop	$I_F = 70\text{ A}$		$T_{VJ} = 25^\circ\text{C}$		1,23	V
		$I_F = 210\text{ A}$				1,75	V
		$I_F = 70\text{ A}$		$T_{VJ} = 125^\circ\text{C}$		1,19	V
		$I_F = 210\text{ A}$				1,67	V
$I_{DAV}$	bridge output current	$T_C = 85^\circ\text{C}$		$T_{VJ} = 150^\circ\text{C}$		210	A
		rectangular	$d = \frac{1}{3}$				
$V_{FO}$	threshold voltage			$T_{VJ} = 150^\circ\text{C}$		0,82	V
$r_F$	slope resistance					5,2	m $\Omega$
						} for power loss calculation only	
$R_{thJC}$	thermal resistance junction to case					0,5	K/W
$R_{thCH}$	thermal resistance case to heatsink				0,1		K/W
$P_{tot}$	total power dissipation			$T_C = 25^\circ\text{C}$		250	W
$I_{FSM}$	max. forward surge current	$t = 10\text{ ms}; (50\text{ Hz}), \text{ sine}$		$T_{VJ} = 45^\circ\text{C}$		1,00	kA
		$t = 8,3\text{ ms}; (60\text{ Hz}), \text{ sine}$		$V_R = 0\text{ V}$		1,08	kA
		$t = 10\text{ ms}; (50\text{ Hz}), \text{ sine}$		$T_{VJ} = 150^\circ\text{C}$		850	A
		$t = 8,3\text{ ms}; (60\text{ Hz}), \text{ sine}$		$V_R = 0\text{ V}$		920	A
$I^2t$	value for fusing	$t = 10\text{ ms}; (50\text{ Hz}), \text{ sine}$		$T_{VJ} = 45^\circ\text{C}$		5,00	kA <sup>2</sup> s
		$t = 8,3\text{ ms}; (60\text{ Hz}), \text{ sine}$		$V_R = 0\text{ V}$		4,85	kA <sup>2</sup> s
		$t = 10\text{ ms}; (50\text{ Hz}), \text{ sine}$		$T_{VJ} = 150^\circ\text{C}$		3,62	kA <sup>2</sup> s
		$t = 8,3\text{ ms}; (60\text{ Hz}), \text{ sine}$		$V_R = 0\text{ V}$		3,52	kA <sup>2</sup> s
$C_J$	junction capacitance	$V_R = 400\text{ V}; f = 1\text{ MHz}$		$T_{VJ} = 25^\circ\text{C}$		33	pF

Brake IGBT + Diode				Ratings					
Symbol	Definition	Conditions	min.	typ.	max.	Unit			
$V_{CES}$	collector emitter voltage	$T_{VJ} = 25^{\circ}C$			1700	V			
$V_{GES}$	max. DC gate voltage				$\pm 20$	V			
$V_{GEM}$	max. transient gate emitter voltage				$\pm 30$	V			
$I_{C25}$	collector current	$T_C = 25^{\circ}C$			145	A			
$I_{C80}$		$T_C = 80^{\circ}C$			100	A			
$P_{tot}$	total power dissipation	$T_C = 25^{\circ}C$			540	W			
$V_{CE(sat)}$	collector emitter saturation voltage	$I_C = 75\text{ A}; V_{GE} = 15\text{ V}$			1,8	V			
					2,1	V			
$V_{GE(th)}$	gate emitter threshold voltage	$I_C = 4\text{ mA}; V_{GE} = V_{CE}$	5,2	5,8	6,4	V			
$I_{CES}$	collector emitter leakage current	$V_{CE} = V_{CES}; V_{GE} = 0\text{ V}$			0,1	mA			
					0,7	mA			
$I_{GES}$	gate emitter leakage current	$V_{GE} = \pm 20\text{ V}$			500	nA			
$Q_{G(on)}$	total gate charge	$V_{CE} = 900\text{ V}; V_{GE} = 15\text{ V}; I_C = 75\text{ A}$		1200		nC			
$t_{d(on)}$	turn-on delay time	inductive load $V_{CE} = 900\text{ V}; I_C = 75\text{ A}$ $V_{GE} = \pm 15\text{ V}; R_G = 3,9\ \Omega$							
$t_r$	current rise time						$T_{VJ} = 125^{\circ}C$	320	ns
$t_{d(off)}$	turn-off delay time						50	ns	
$t_f$	current fall time						550	ns	
$E_{on}$	turn-on energy per pulse						400	ns	
$E_{off}$	turn-off energy per pulse						15	mJ	
		18	mJ						
<b>RBSOA</b>	reverse bias safe operating area	$V_{GE} = \pm 15\text{ V}; R_G = 3,9\ \Omega$							
$I_{CM}$		$V_{CEK} = 1700\text{ V}$			200	A			
<b>SCSOA</b>	short circuit safe operating area	$V_{CEK} = 1700\text{ V}$							
$t_{SC}$	short circuit duration	$V_{CE} = 900\text{ V}; V_{GE} = \pm 15$			10	$\mu s$			
$I_{SC}$	short circuit current	$R_G = 3,9\ \Omega$ ; non-repetitive		400		A			
$R_{thJC}$	thermal resistance junction to case				0,23	K/W			
$R_{thCH}$	thermal resistance case to heatsink				0,08	K/W			
<b>Brake Diode</b>									
$V_{RRM}$	max. repetitive reverse voltage	$T_{VJ} = 25^{\circ}C$			1700	V			
$I_{F25}$	forward current	$T_C = 25^{\circ}C$			81	A			
$I_{F80}$		$T_C = 80^{\circ}C$			54	A			
$V_F$	forward voltage	$I_F = 60\text{ A}$			2,20	V			
					2,00	V			
$I_R$	reverse current	$V_R = V_{RRM}$			0,1	mA			
					1,2	mA			
$Q_{rr}$	reverse recovery charge	$V_R = 900\text{ V}$ $-di_F/dt = 1600\text{ A}/\mu s$ $I_F = 60\text{ A}; V_{GE} = 0\text{ V}$							
$I_{RM}$	max. reverse recovery current						$T_{VJ} = 125^{\circ}C$	15	$\mu C$
$t_{rr}$	reverse recovery time						100	A	
$E_{rec}$	reverse recovery energy						550	ns	
					6,5	mJ			
$R_{thJC}$	thermal resistance junction to case				0,6	K/W			
$R_{thCH}$	thermal resistance case to heatsink				0,2	K/W			

Package E2-Pack		Ratings				
Symbol	Definition	Conditions	min.	typ.	max.	Unit
$I_{RMS}$	RMS current	per terminal			30	A
$T_{VJ}$	virtual junction temperature		-40		150	°C
$T_{op}$	operation temperature		-40		125	°C
$T_{stg}$	storage temperature		-40		125	°C
<b>Weight</b>				176		g
$M_D$	mounting torque		3		6	Nm
$d_{Spp/App}$	creepage distance on surface   striking distance through air	terminal to terminal	6,0			mm
$d_{Spb/Apb}$		terminal to backside	12,0			mm
$V_{ISOL}$	isolation voltage	t = 1 second t = 1 minute	4300			V
		50/60 Hz, RMS; $I_{ISOL} \leq 1$ mA	3600			V



### Part description

M = Module  
 D = Diode  
 N = High Voltage Standard Rectifier  
 A = ( $\geq 2000V$ )  
 210 = Current Rating [A]  
 UB = 3- Rectifier Bridge + Brake Unit  
 2200 = Reverse Voltage [V]  
 PT = PressFit-Pin, Thermistor  
 ED = E2-Pack  
 - = Hyphen  
 PC = Phase Change Material

Ordering	Ordering Number	Marking on Product	Delivery Mode	Quantity	Code No.
Standard	MDNA210UB2200PTED	MDNA210UB2200PTED	Blister	28	515668
Alternative	MDNA210UB2200PTED-PC	MDNA210UB2200PTED	Blister	28	515430

### Temperature Sensor NTC

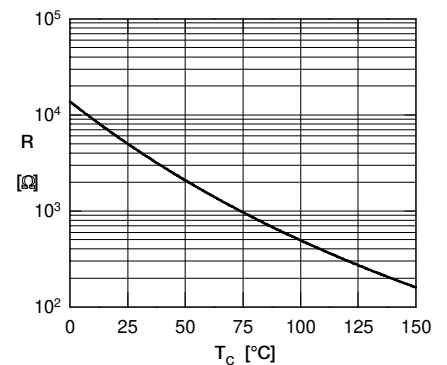
Symbol	Definition	Conditions	min.	typ.	max.	Unit
$R_{25}$	resistance	$T_{VJ} = 25^\circ$	4,85	5	5,15	k $\Omega$
$B_{25/50}$	temperature coefficient			3375		K

### Equivalent Circuits for Simulation

\* on die level

$T_{VJ} = 150^\circ C$

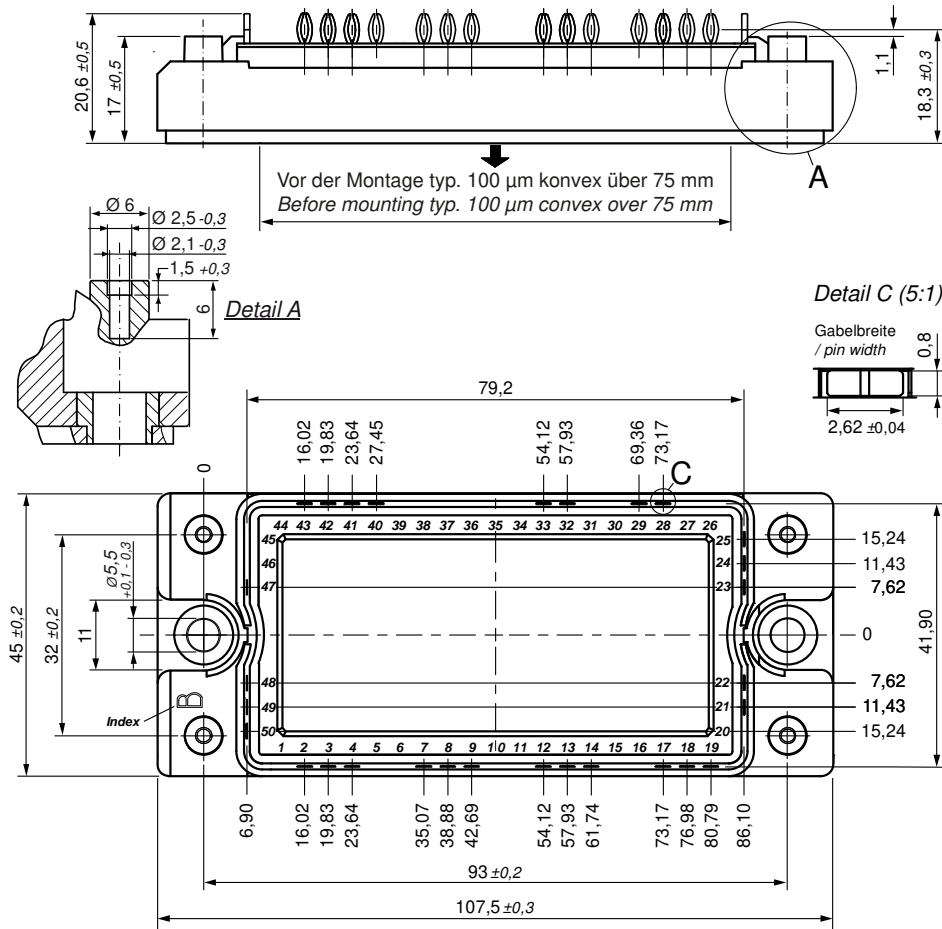
		Rectifier	Brake IGBT +	Brake Diode	
$V_0$	threshold voltage	0,82	1,1	1,22	V
$R_0$	slope resistance *	3,1	17,9	13	m $\Omega$



Typ. NTC resistance vs. temperature



**Outlines E2-Pack**

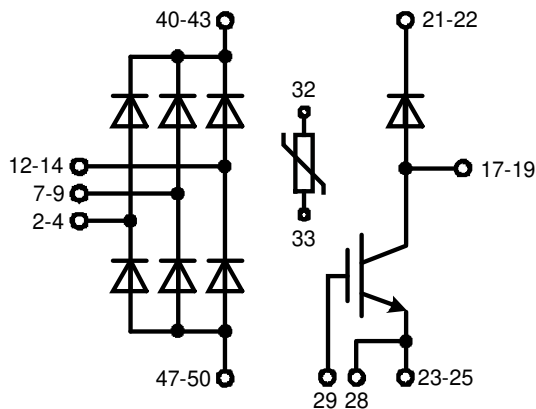


**Bemerkung / Note:**

- Nicht tolerierte Maße nach / Measure without tolerances according DIN ISO 2768-T1-m
- PCB-Lochmuster / PCB hole pattern: **see pin position**
- Toleranz Pin-Position und PCB-Lochmuster / Tolerance of pin position and PCB hole pattern:  $\oplus 0,1$
- Bohrlochdurchmesser / Diameter of drill: **Ø 2.35 mm**
- Endlochdurchmesser / Diameter of plated holes: **Ø 2.14 - 2.29 mm** (Cu thickness in via typ. 50 µm)
- Beschichtung / Plating: **chem. Sn max. 15 µm**
- Einpresskraft / Insert Force: per terminal with a typ. insert speed of 7 mm/s: **typ. 90 N**
- Weitere Angaben / Further information: [www.ixys.com](http://www.ixys.com) **Application note IXAN0077**
- Montageanleitung / Mounting instruction: [www.ixys.com](http://www.ixys.com) **Application note IXAN0024**

**Detail A:** PCB-Montage / Mounting on PCB-

- Empfohlene, selbstschneidende Schraube / Recommended, self-tapping screw: **EJOT PT®** (Größe / size: **K25**)
- Max. Schraubenlänge / Max. screw length: **PCB-Dicke / thickness + 6 mm** (max. Lochtiefe / hole depth)
- Empfohlenes Drehmoment / Recommended mounting torque: **1.5 Nm**



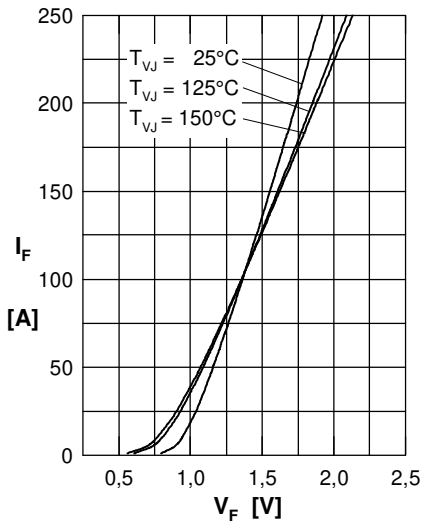
**Rectifier**


Fig. 1 Forward current versus voltage drop per diode

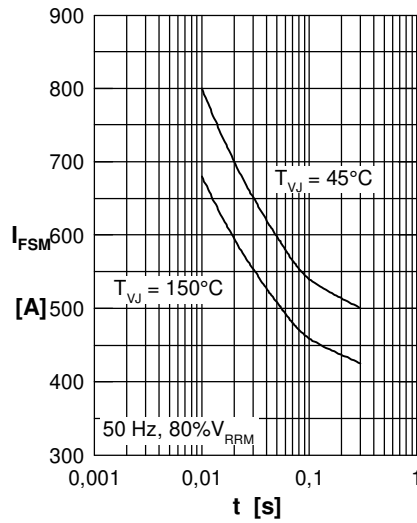


Fig. 2 Surge overload current vs. time per diode

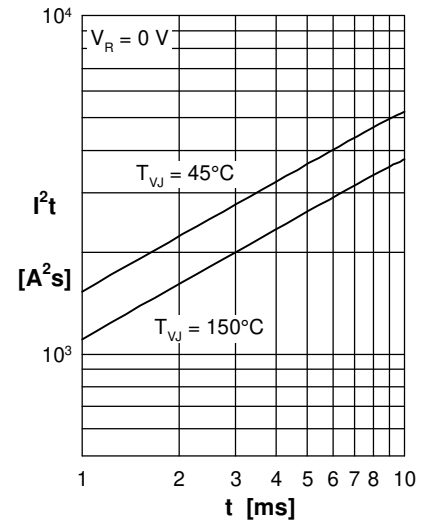
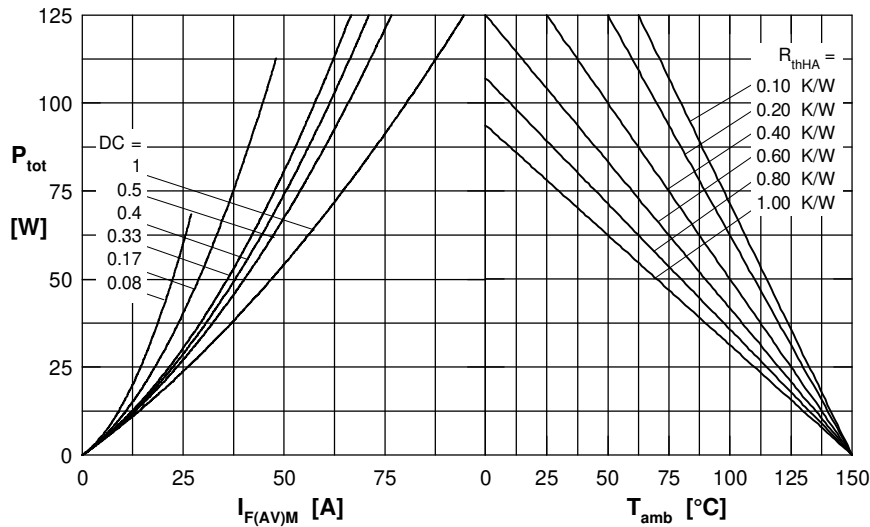

 Fig. 3  $I^2t$  versus time per diode


Fig. 4 Power dissipation vs. forward current and ambient temperature per diode

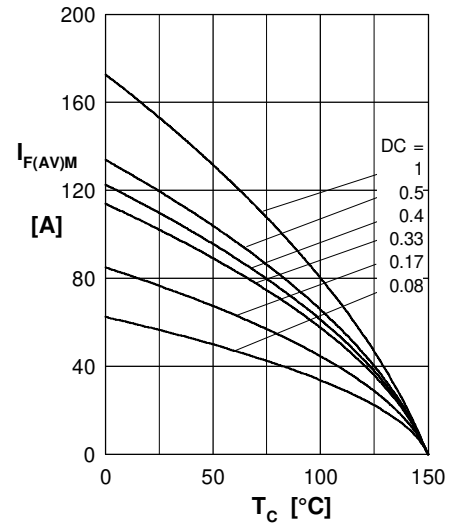


Fig. 5 Max. forward current vs. case temperature per diode

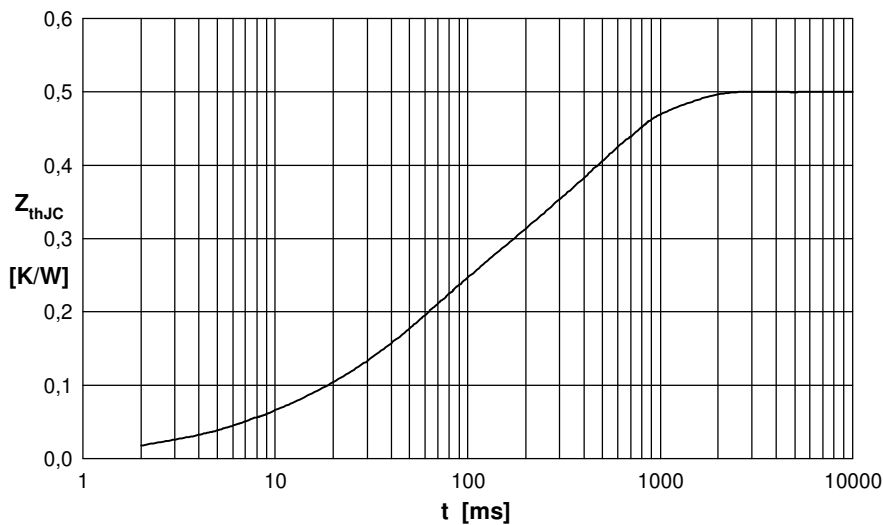


Fig. 6 Transient thermal impedance junction to case vs. time per diode

 Constants for  $Z_{thJC}$  calculation:

i	$R_{thi}$ (K/W)	$t_i$ (s)
1	0.030	0.006
2	0.003	0.007
3	0.182	0.045
4	0.285	0.450

## Brake IGBT + Diode

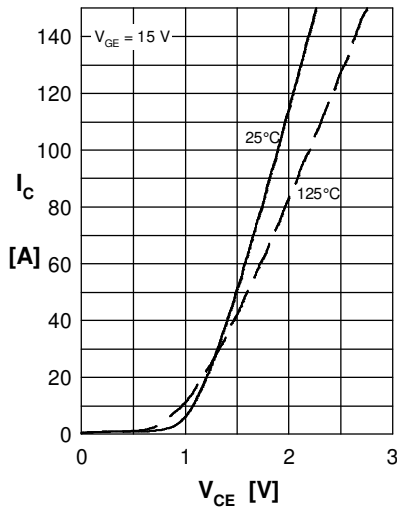


Fig.1 Output characteristics IGBT

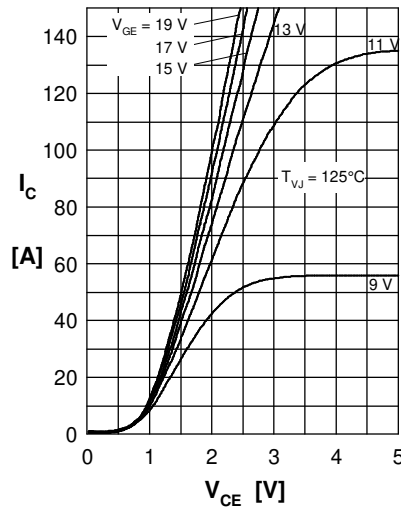


Fig.2 Typ. output characteristics IGBT

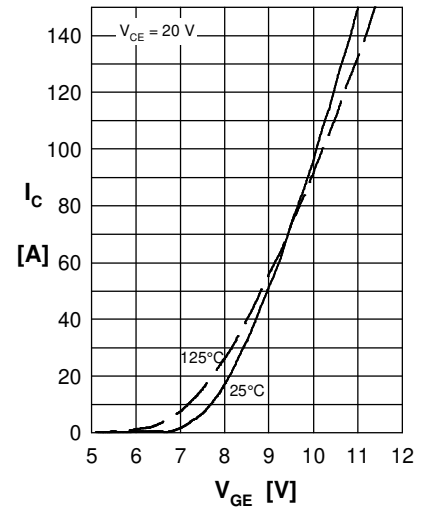


Fig.3 Typ. transfer charact. IGBT

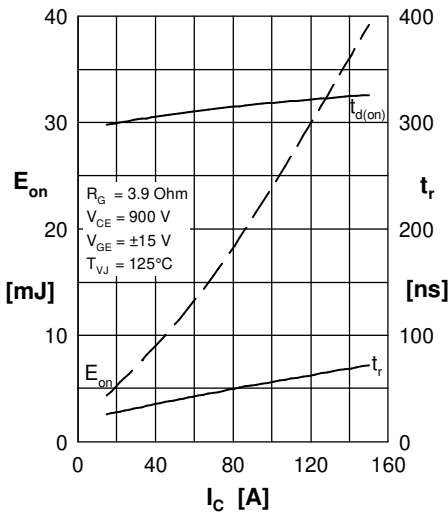


Fig.4 Typ. turn-on energy & switch. times vs. collector current

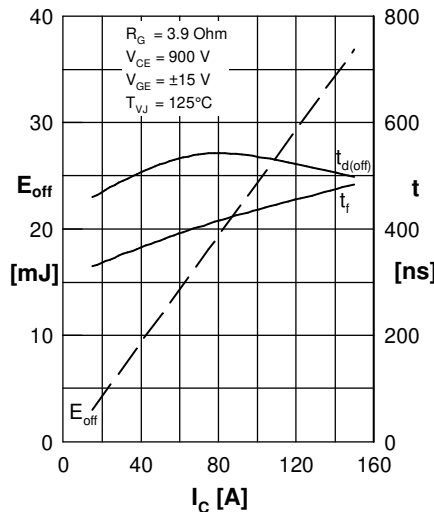


Fig.5 Typ. turn-off energy & switch. times vs. collector current

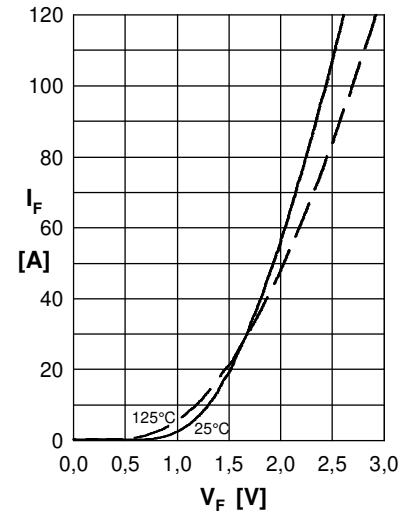


Fig.6 Typ. forward characteristics Diode

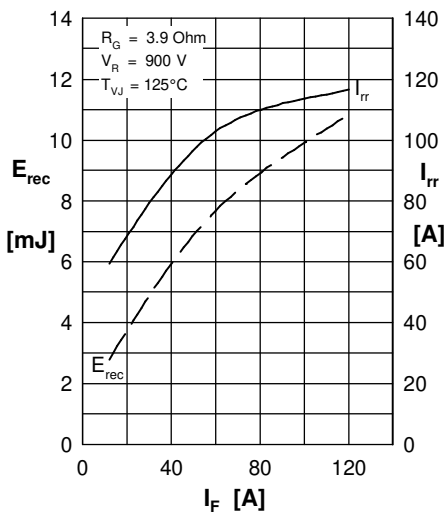


Fig.7 Typ. reverse recovery characteristics Diode

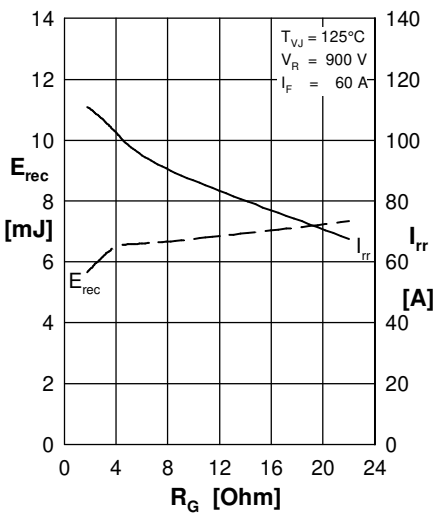


Fig.8 Typ. reverse recovery characteristics Diode

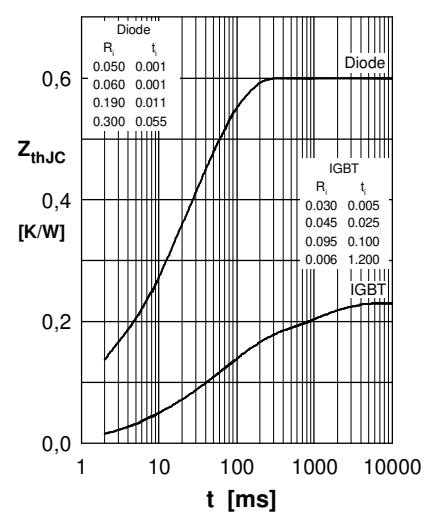


Fig.9 Transient thermal resistance junction to case