

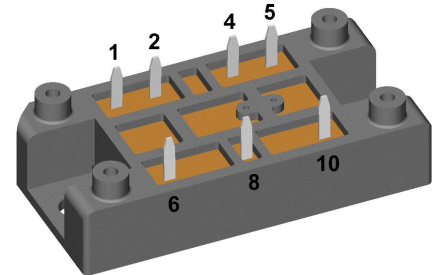
Standard Rectifier Module

3~ Rectifier
$V_{RRM} = 1600\text{ V}$
$I_{DAV} = 150\text{ A}$
$I_{FSM} = 1100\text{ A}$


3~ Rectifier Bridge

Part number

MDMA150U1600VA



Backside: isolated

 E72873



Features / Advantages:

- Package with DCB ceramic
- Improved temperature and power cycling
- Planar passivated chips
- Very low forward voltage drop
- Very low leakage current

Applications:

- Diode for main rectification
- For three phase bridge configurations
- Supplies for DC power equipment
- Input rectifiers for PWM inverter
- Battery DC power supplies
- Field supply for DC motors

Package: V1-A-Pack

- Isolation Voltage: 3600 V~
- Industry standard outline
- RoHS compliant
- Soldering pins for PCB mounting
- Height: 17 mm
- Base plate: DCB ceramic
- Reduced weight
- Advanced power cycling

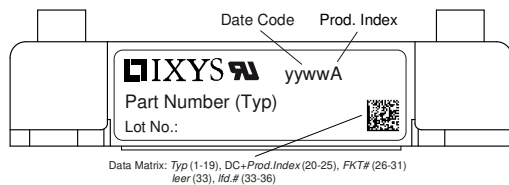
Disclaimer Notice

Information furnished is believed to be accurate and reliable. However, users should independently evaluate the suitability of and test each product selected for their own applications. Littelfuse products are not designed for, and may not be used in, all applications. Read complete Disclaimer Notice at www.littelfuse.com/disclaimer-electronics.

Rectifier				Ratings			
Symbol	Definition	Conditions		min.	typ.	max.	Unit
V_{RSM}	max. non-repetitive reverse blocking voltage					1700	V
V_{RRM}	max. repetitive reverse blocking voltage					1600	V
I_R	reverse current	$V_R = 1600$ V		$T_{VJ} = 25^\circ\text{C}$		40	μA
		$V_R = 1600$ V		$T_{VJ} = 150^\circ\text{C}$		1.5	mA
V_F	forward voltage drop	$I_F = 50$ A		$T_{VJ} = 25^\circ\text{C}$		1.17	V
		$I_F = 150$ A				1.51	V
		$I_F = 50$ A		$T_{VJ} = 125^\circ\text{C}$		1.09	V
		$I_F = 150$ A				1.53	V
I_{DAV}	bridge output current	$T_C = 110^\circ\text{C}$	rectangular	$T_{VJ} = 150^\circ\text{C}$		150	A
V_{FO}	threshold voltage	} for power loss calculation only		$T_{VJ} = 150^\circ\text{C}$		0.83	V
r_F	slope resistance					4.7	m Ω
R_{thJC}	thermal resistance junction to case					0.5	K/W
R_{thCH}	thermal resistance case to heatsink				0.2		K/W
P_{tot}	total power dissipation			$T_C = 25^\circ\text{C}$		190	W
I_{FSM}	max. forward surge current	$t = 10$ ms; (50 Hz), sine		$T_{VJ} = 45^\circ\text{C}$		1.10	kA
		$t = 8,3$ ms; (60 Hz), sine		$V_R = 0$ V		1.19	kA
		$t = 10$ ms; (50 Hz), sine		$T_{VJ} = 150^\circ\text{C}$		935	A
		$t = 8,3$ ms; (60 Hz), sine		$V_R = 0$ V		1.01	kA
I^2t	value for fusing	$t = 10$ ms; (50 Hz), sine		$T_{VJ} = 45^\circ\text{C}$		6.05	kA ² s
		$t = 8,3$ ms; (60 Hz), sine		$V_R = 0$ V		5.89	kA ² s
		$t = 10$ ms; (50 Hz), sine		$T_{VJ} = 150^\circ\text{C}$		4.37	kA ² s
		$t = 8,3$ ms; (60 Hz), sine		$V_R = 0$ V		4.25	kA ² s
C_J	junction capacitance	$V_R = 400$ V; $f = 1$ MHz		$T_{VJ} = 25^\circ\text{C}$		33	pF



Package V1-A-Pack		Ratings				
Symbol	Definition	Conditions	min.	typ.	max.	Unit
I_{RMS}	RMS current	per terminal			100	A
T_{VJ}	virtual junction temperature		-40		150	°C
T_{op}	operation temperature		-40		125	°C
T_{stg}	storage temperature		-40		125	°C
Weight				37		g
M_D	mounting torque		2		2.5	Nm
$d_{Spp/App}$	creepage distance on surface / striking distance through air	terminal to terminal	6.0			mm
$d_{Spb/Apb}$		terminal to backside	12.0			mm
V_{ISOL}	isolation voltage	t = 1 second t = 1 minute	3600 3000			V V
		50/60 Hz, RMS; $I_{ISOL} \leq 1$ mA				



Part description

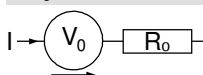
- M = Module
- D = Diode
- M = Standard Rectifier
- A = (up to 1800V)
- 150 = Current Rating [A]
- U = 3- Rectifier Bridge
- 1600 = Reverse Voltage [V]
- VA = V1-A-Pack

Ordering	Ordering Number	Marking on Product	Delivery Mode	Quantity	Code No.
Standard	MDMA150U1600VA	MDMA150U1600VA	Blister	24	525355

Equivalent Circuits for Simulation

* on die level

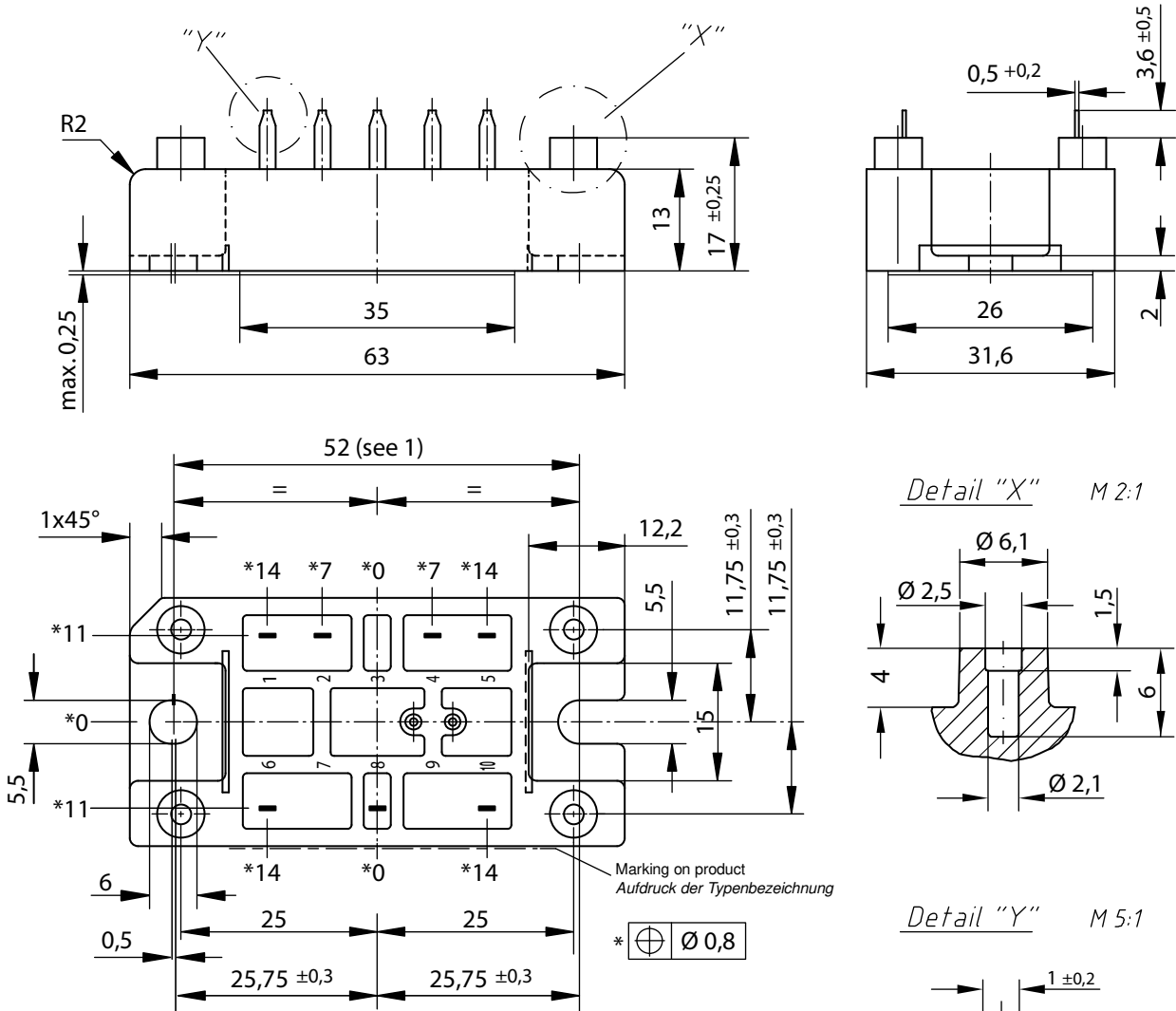
$T_{VJ} = 150^{\circ}\text{C}$



$V_{0\ max}$	threshold voltage	0.83	V
$R_{0\ max}$	slope resistance *	3.4	mΩ

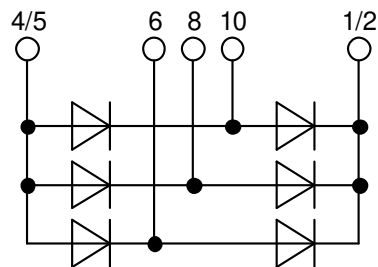


Outlines V1-A-Pack



Remarks / Bemerkungen:

1. Nominal distance mounting screws on heat sink: 52 mm / Nennabstand Befestigungsschrauben auf Kühlkörper: 52 mm
2. General tolerance / Allgemeintoleranz: DIN ISO 2768 -T1-c
3. Surface treatment of pins: tin plated (Sn) in hot dip / Oberflächenbehandlung der Pins: verzinkt (Sn) im Tauchbad
4. Detail X: EJOT PT® self-tapping screws (dimension K25) to be recommended for mounting on PCB
selbstschneidende Schraube (Größe K25) empfohlen für die PCB-Montage
Take care on the maximum screw length according to board thickness and the maximum hole depth of 6 mm^L
Bei der Wahl der Schraubenlänge die PCB-Dicke und die maximale Lochtiefe von 6mm beachten
Recommended mounting torque: 1.5 Nm / Empfohlenes Drehmoment: 1.5 Nm



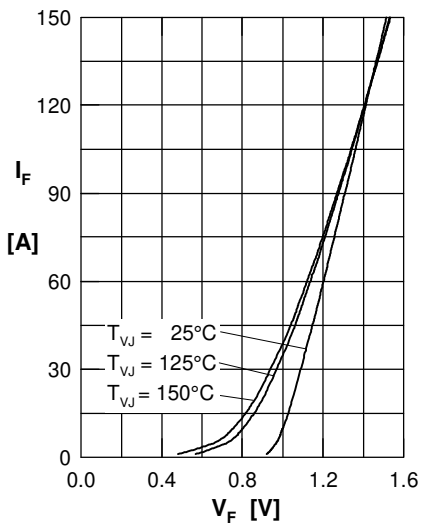
Rectifier


Fig. 1 Forward current versus voltage drop per diode

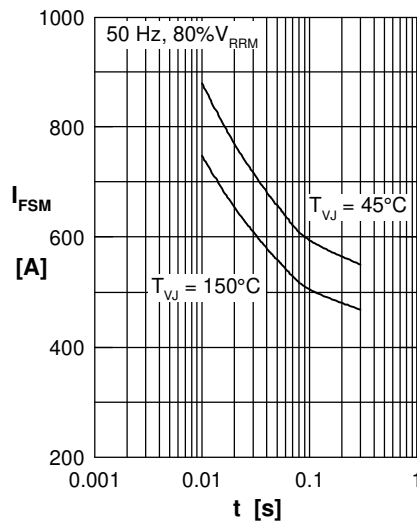


Fig. 2 Surge overload current vs. time per diode

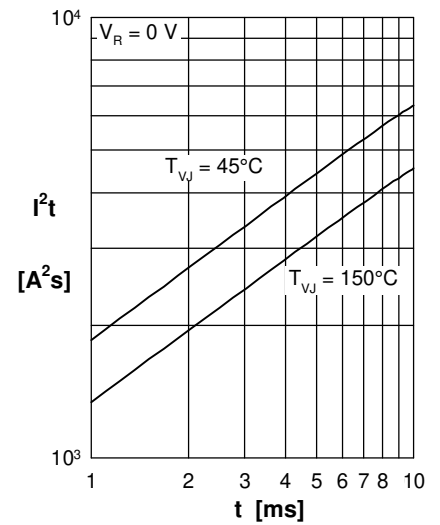
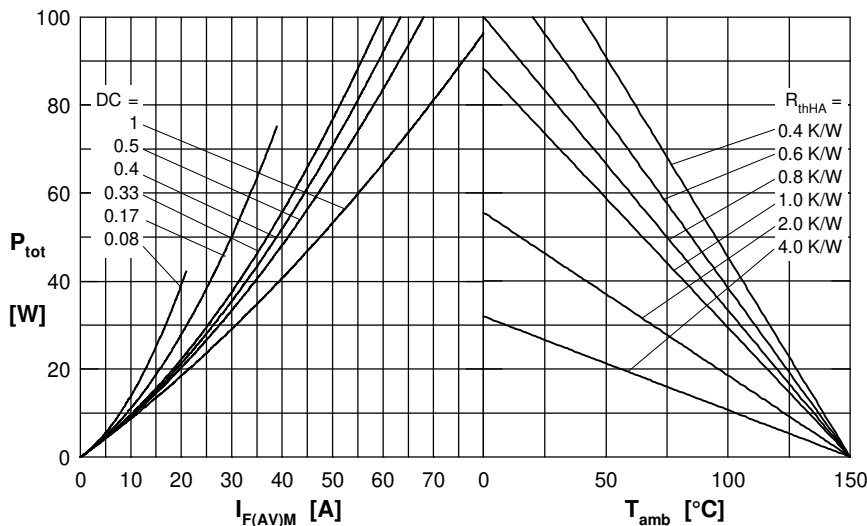

 Fig. 3 I^2t versus time per diode


Fig. 4 Power dissipation vs. forward current and ambient temperature per diode

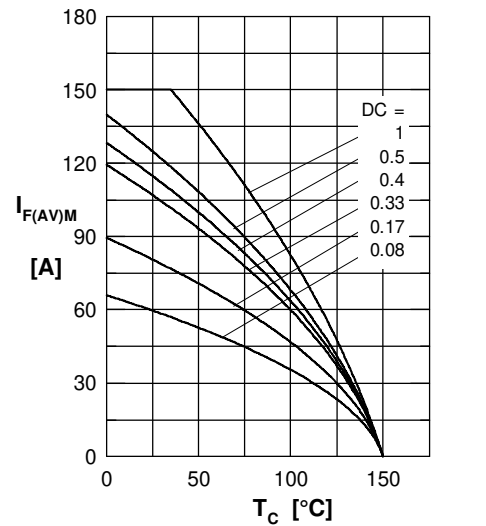


Fig. 5 Max. forward current vs. case temperature per diode

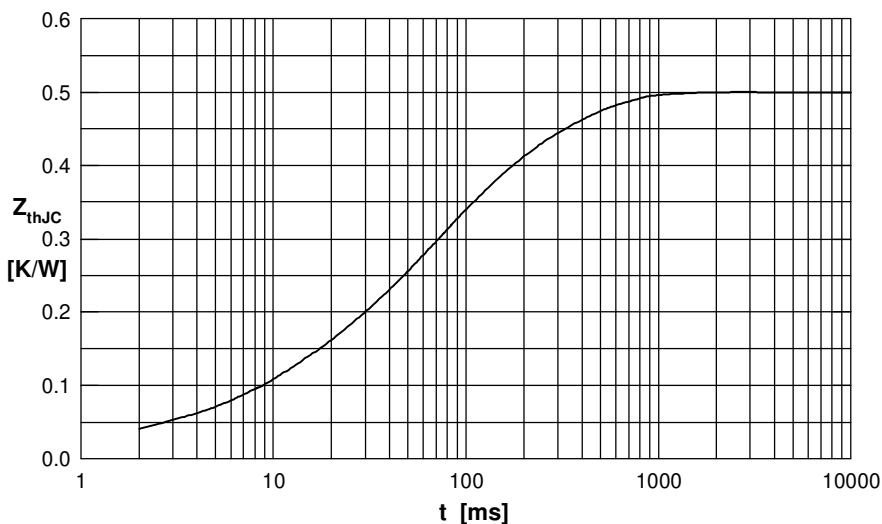


Fig. 6 Transient thermal impedance junction to case vs. time per diode

 Constants for Z_{thJC} calculation:

i	R_{thi} (K/W)	t_i (s)
1	0.022	0.001
2	0.068	0.010
3	0.245	0.060
4	0.165	0.270