

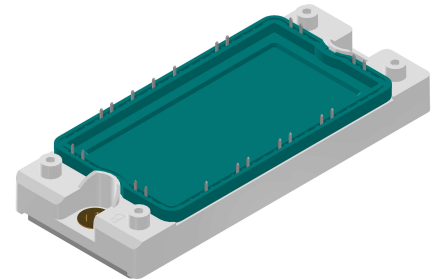
High Voltage Thyristor Module

3~ Rectifier	Brake Chopper
$V_{RRM} = 2200\text{ V}$	$V_{CES} = 1700\text{ V}$
$I_{DAV} = 120\text{ A}$	$I_{C25} = 113\text{ A}$
$I_{FSM} = 500\text{ A}$	$V_{CE(sat)} = 2.5\text{ V}$

3~ Rectifier Bridge, half-controlled (high-side) + Brake Unit + NTC

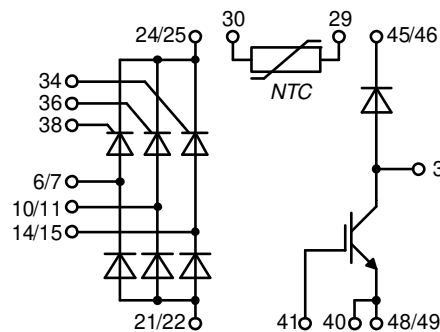
Part number

MCNA120UI2200TED



Backside: isolated

 E72873



Features / Advantages:

- Thyristor/Standard Rectifier for line frequency
- Planar passivated chips
- Long-term stability
- Low forward voltage drop
- Leads suitable for PC board soldering
- Copper base plate with Direct Copper Bonded Al₂O₃-ceramic
- Improved temperature and power cycling

Applications:

- 3~ Rectifier with brake unit for drive inverters

Package: E2-Pack

- Isolation Voltage: 3600 V~
- Industry standard outline
- RoHS compliant
- Soldering pins for PCB mounting
- Height: 17 mm
- Base plate: Copper internally DCB isolated
- Advanced power cycling
- Phase Change Material available

Disclaimer Notice

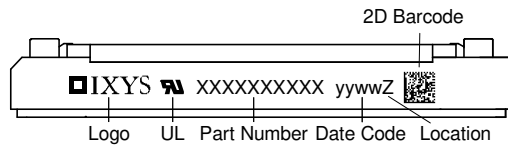
Information furnished is believed to be accurate and reliable. However, users should independently evaluate the suitability of and test each product selected for their own applications. Littelfuse products are not designed for, and may not be used in, all applications. Read complete Disclaimer Notice at www.littelfuse.com/disclaimer-electronics.



Rectifier			Ratings			
Symbol	Definition	Conditions	min.	typ.	max.	Unit
$V_{RSM/DSM}$	max. non-repetitive reverse/forward blocking voltage	$T_{VJ} = 25^{\circ}C$			2300	V
$V_{RRM/DRM}$	max. repetitive reverse/forward blocking voltage	$T_{VJ} = 25^{\circ}C$			2200	V
I_{RD}	reverse current, drain current	$V_{R/D} = 2200 V$	$T_{VJ} = 25^{\circ}C$		50	μA
		$V_{R/D} = 2200 V$	$T_{VJ} = 125^{\circ}C$		10	mA
V_T	forward voltage drop	$I_T = 40 A$	$T_{VJ} = 25^{\circ}C$		1.33	V
		$I_T = 120 A$			2.05	V
		$I_T = 40 A$	$T_{VJ} = 125^{\circ}C$		1.36	V
		$I_T = 120 A$			2.38	V
I_{DAV}	bridge output current	$T_C = 80^{\circ}C$ rectangular $d = 1/3$	$T_{VJ} = 150^{\circ}C$		120	A
V_{T0}	threshold voltage	} for power loss calculation only	$T_{VJ} = 150^{\circ}C$		0.83	V
r_T	slope resistance				13.6	m Ω
R_{thJC}	thermal resistance junction to case				0.65	K/W
R_{thCH}	thermal resistance case to heatsink			0.1		K/W
P_{tot}	total power dissipation		$T_C = 25^{\circ}C$		190	W
I_{TSM}	max. forward surge current	$t = 10 ms; (50 Hz), sine$	$T_{VJ} = 45^{\circ}C$		500	A
		$t = 8,3 ms; (60 Hz), sine$	$V_R = 0 V$		540	A
		$t = 10 ms; (50 Hz), sine$	$T_{VJ} = 150^{\circ}C$		425	A
		$t = 8,3 ms; (60 Hz), sine$	$V_R = 0 V$		460	A
I^2t	value for fusing	$t = 10 ms; (50 Hz), sine$	$T_{VJ} = 45^{\circ}C$		1.25	kA ² s
		$t = 8,3 ms; (60 Hz), sine$	$V_R = 0 V$		1.22	kA ² s
		$t = 10 ms; (50 Hz), sine$	$T_{VJ} = 150^{\circ}C$		905	A ² s
		$t = 8,3 ms; (60 Hz), sine$	$V_R = 0 V$		880	A ² s
C_J	junction capacitance	$V_R = 700 V f = 1 MHz$	$T_{VJ} = 25^{\circ}C$		13	pF
P_{GM}	max. gate power dissipation	$t_p = 30 \mu s$	$T_C = 150^{\circ}C$		10	W
		$t_p = 300 \mu s$			5	W
P_{GAV}	average gate power dissipation				0.5	W
$(di/dt)_{cr}$	critical rate of rise of current	$T_{VJ} = 150^{\circ}C; f = 50 Hz$ repetitive, $I_T = 120 A$			150	A/ μs
		$t_p = 200 \mu s; di_G/dt = 0.45 A/\mu s;$ $I_G = 0.45 A; V = 2/3 V_{DRM}$ non-repet., $I_T = 40 A$			500	A/ μs
$(dv/dt)_{cr}$	critical rate of rise of voltage	$V = 2/3 V_{DRM}$ $R_{GK} = \infty; method 1 (linear voltage rise)$	$T_{VJ} = 150^{\circ}C$		1000	V/ μs
V_{GT}	gate trigger voltage	$V_D = 6 V$	$T_{VJ} = 25^{\circ}C$		1.4	V
			$T_{VJ} = -40^{\circ}C$		1.6	V
I_{GT}	gate trigger current	$V_D = 6 V$	$T_{VJ} = 25^{\circ}C$		70	mA
			$T_{VJ} = -40^{\circ}C$		150	mA
V_{GD}	gate non-trigger voltage	$V_D = 2/3 V_{DRM}$	$T_{VJ} = 150^{\circ}C$		0.2	V
I_{GD}	gate non-trigger current				5	mA
I_L	latching current	$t_p = 10 \mu s$	$T_{VJ} = 25^{\circ}C$		150	mA
		$I_G = 0.45 A; di_G/dt = 0.45 A/\mu s$				
I_H	holding current	$V_D = 6 V R_{GK} = \infty$	$T_{VJ} = 25^{\circ}C$		100	mA
t_{gd}	gate controlled delay time	$V_D = 1/2 V_{DRM}$ $I_G = 0.45 A; di_G/dt = 0.45 A/\mu s$	$T_{VJ} = 25^{\circ}C$		2	μs
t_q	turn-off time	$V_R = 100 V; I_T = 40 A; V = 2/3 V_{DRM}$ $di/dt = 10 A/\mu s dv/dt = 20 V/\mu s t_p = 200 \mu s$	$T_{VJ} = 125^{\circ}C$	500		μs

Brake IGBT + Diode				Ratings					
Symbol	Definition	Conditions	min.	typ.	max.	Unit			
V_{CES}	collector emitter voltage	$T_{VJ} = 25^{\circ}\text{C}$			1700	V			
V_{GES}	max. DC gate voltage				± 20	V			
V_{GEM}	max. transient gate emitter voltage				± 30	V			
I_{C25}	collector current	$T_C = 25^{\circ}\text{C}$			113	A			
I_{C80}		$T_C = 80^{\circ}\text{C}$			80	A			
P_{tot}	total power dissipation	$T_C = 25^{\circ}\text{C}$			445	W			
$V_{CE(sat)}$	collector emitter saturation voltage	$I_C = 75\text{ A}; V_{GE} = 15\text{ V}$			2.5	V			
					3	V			
$V_{GE(th)}$	gate emitter threshold voltage	$I_C = 3\text{ mA}; V_{GE} = V_{CE}$	5.2	5.8	6.4	V			
I_{CES}	collector emitter leakage current	$V_{CE} = V_{CES}; V_{GE} = 0\text{ V}$			0.6	mA			
					5	mA			
I_{GES}	gate emitter leakage current	$V_{GE} = \pm 20\text{ V}$			400	nA			
$Q_{G(on)}$	total gate charge	$V_{CE} = 900\text{ V}; V_{GE} = 15\text{ V}; I_C = 75\text{ A}$		850		nC			
$t_{d(on)}$	turn-on delay time	inductive load $V_{CE} = 900\text{ V}; I_C = 75\text{ A}$ $V_{GE} = \pm 15\text{ V}; R_G = 18\ \Omega$							
t_r	current rise time						$T_{VJ} = 125^{\circ}\text{C}$	270	ns
$t_{d(off)}$	turn-off delay time						100	ns	
t_f	current fall time						700	ns	
E_{on}	turn-on energy per pulse						430	ns	
E_{off}	turn-off energy per pulse						34	mJ	
		17.5	mJ						
RBSOA	reverse bias safe operating area	$V_{GE} = \pm 15\text{ V}; R_G = 18\ \Omega$							
I_{CM}		$V_{CEK} = 1700\text{ V}$			150	A			
SCSOA	short circuit safe operating area	$V_{CEK} = 1700\text{ V}$							
t_{SC}	short circuit duration	$V_{CE} = 720\text{ V}; V_{GE} = \pm 15$			10	μs			
I_{SC}	short circuit current	$R_G = 18\ \Omega$; non-repetitive			280	A			
R_{thJC}	thermal resistance junction to case				0.28	K/W			
R_{thCH}	thermal resistance case to heatsink				0.1	K/W			
Brake Diode									
V_{RRM}	max. repetitive reverse voltage	$T_{VJ} = 25^{\circ}\text{C}$			1700	V			
I_{F25}	forward current	$T_C = 25^{\circ}\text{C}$			75	A			
I_{F80}		$T_C = 80^{\circ}\text{C}$			50	A			
V_F	forward voltage	$I_F = 60\text{ A}$			2.45	V			
					2.20	V			
I_R	reverse current	$V_R = V_{RRM}$			0.1	mA			
					1	mA			
Q_{rr}	reverse recovery charge	$V_R = 900\text{ V}$ $-di_f/dt = 600\text{ A}/\mu\text{s}$ $I_F = 60\text{ A}; V_{GE} = 0\text{ V}$							
I_{RM}	max. reverse recovery current						$T_{VJ} = 125^{\circ}\text{C}$	20	μC
t_{rr}	reverse recovery time						46	A	
E_{rec}	reverse recovery energy						1300	ns	
					10.5	mJ			
R_{thJC}	thermal resistance junction to case				0.65	K/W			
R_{thCH}	thermal resistance case to heatsink				0.1	K/W			

Package E2-Pack		Ratings				
Symbol	Definition	Conditions	min.	typ.	max.	Unit
I_{RMS}	RMS current	per terminal			40	A
T_{VJ}	virtual junction temperature		-40		150	°C
T_{op}	operation temperature		-40		125	°C
T_{stg}	storage temperature		-40		125	°C
Weight				176		g
M_D	mounting torque		3		6	Nm
$d_{Spp/App}$	creepage distance on surface / striking distance through air	terminal to terminal	6.0			mm
$d_{Spb/Apb}$		terminal to backside	12.0			mm
V_{ISOL}	isolation voltage	t = 1 second t = 1 minute	3600			V
		50/60 Hz, RMS; $I_{ISOL} \leq 1$ mA	3000			V



Part description

M = Module
 C = Thyristor (SCR)
 N = High Voltage Thyristor
 A = ($\geq 2000V$)
 120 = Current Rating [A]
 UI = 3- Rectifier Bridge, half-controlled (high-side) + Brake Unit
 2200 = Reverse Voltage [V]
 T = Thermistor \ Temperature sensor
 ED = E2-Pack

Ordering	Ordering Number	Marking on Product	Delivery Mode	Quantity	Code No.
Standard	MCNA120UI2200TED	MCNA120UI2200TED	Box	36	510374

Temperature Sensor NTC

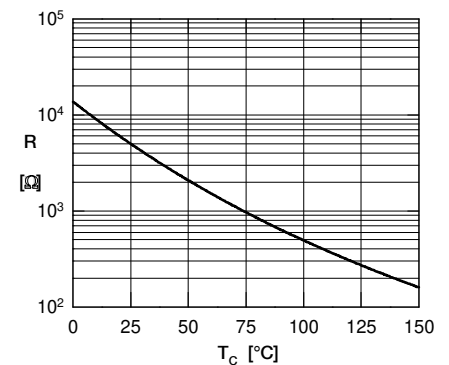
Symbol	Definition	Conditions	min.	typ.	max.	Unit
R_{25}	resistance	$T_{VJ} = 25^\circ$	4.75	5	5.25	k Ω
$B_{25/50}$	temperature coefficient			3375		K

Equivalent Circuits for Simulation

* on die level

$T_{VJ} = 150^\circ C$

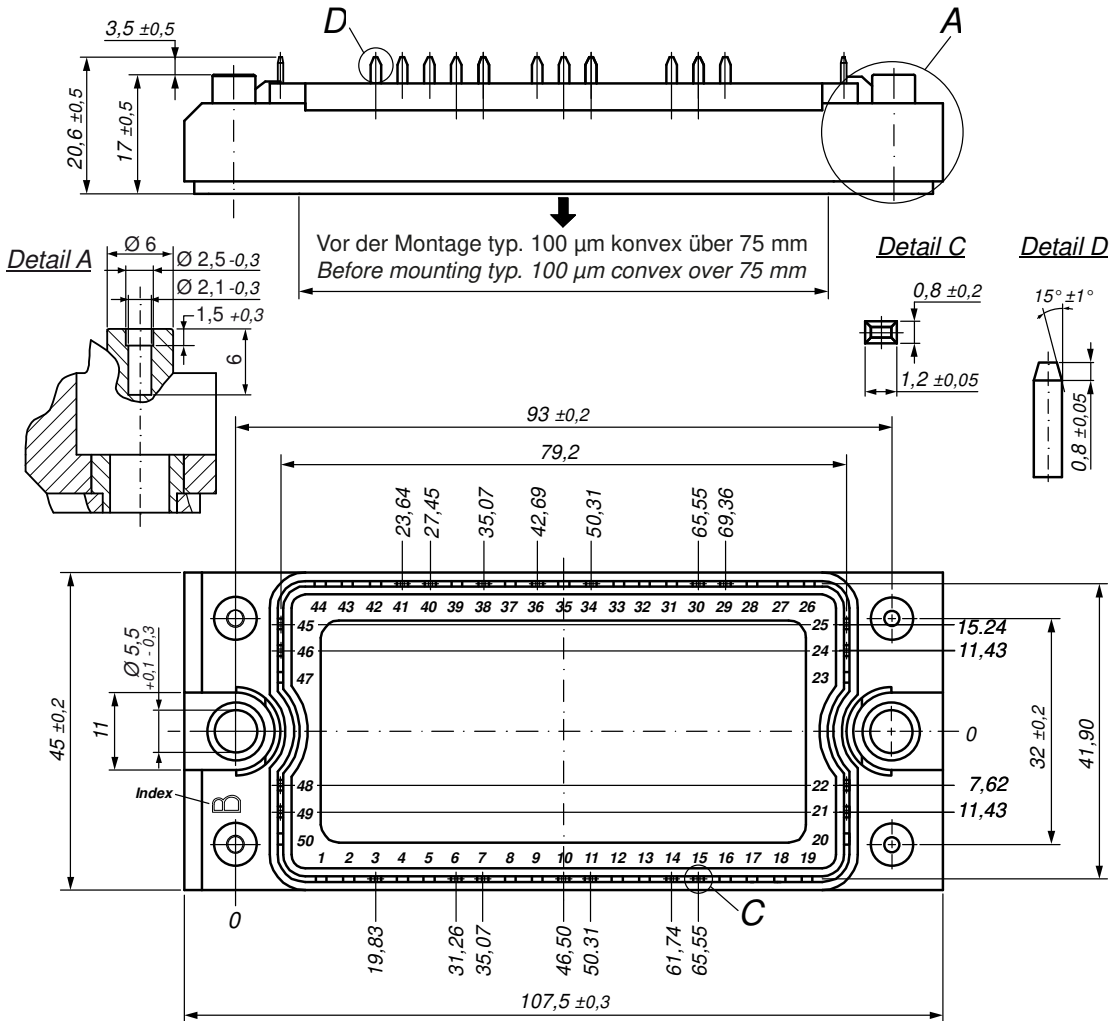
	Thyristor	Brake IGBT +	Brake Diode	
V_0	0.83	1.17	1.34	V
R_0	10.5	25	15.2	m Ω



Typ. NTC resistance vs. temperature



Outlines E2-Pack

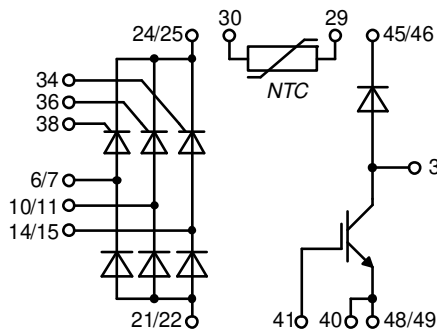


Bemerkung / Note:

- Nichttolerierete Maße nach / *Measure without tolerances according DIN ISO 2768-T1-m*
- PCB-Lochmuster / *PCB hole pattern: see pin position*
- Toleranz Pin-Position und PCB-Lochmuster / *Tolerance of pin position and PCB hole pattern: $\oplus 0.1$*
- Montageanleitung / *Mounting instruction: www.ixys.com Application note IXAN0024*

Detail A: PCB-Montage / *Mounting on PCB*

- Empfohlene, selbstschneidende Schraube / *Recommended, self-tapping screw: EJOT PT® (Größe / size: K25)*^L
- Max. Schraubenlänge / *Max. screw length: PCB-Dicke / thickness + 6 mm (max. Lochtiefe / hole depth)*^L
- Empfohlenes Drehmoment / *Recommended mounting torque: 1.5 Nm*



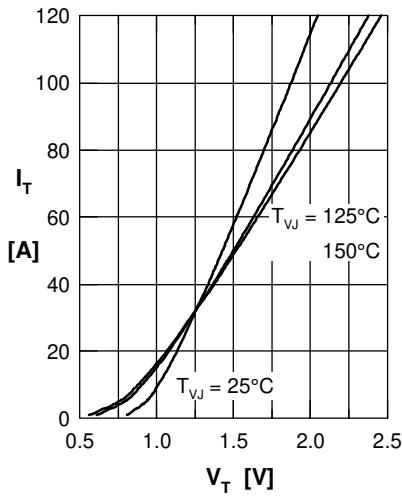
Thyristor


Fig. 1 Forward characteristics

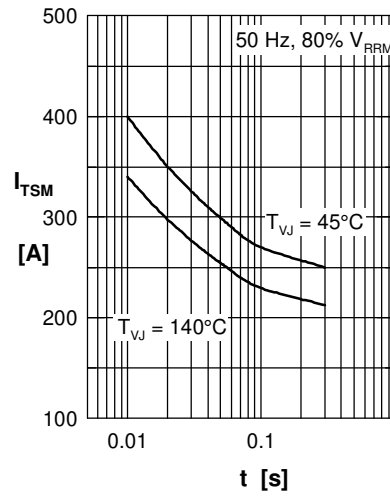
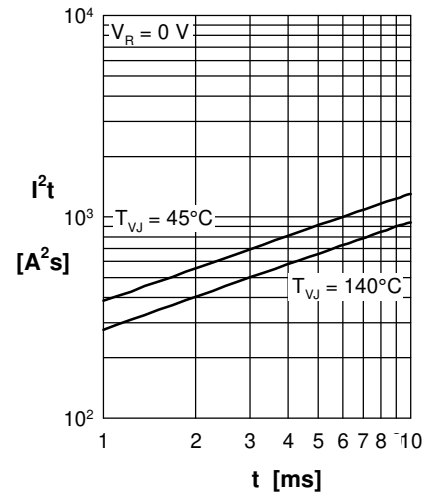
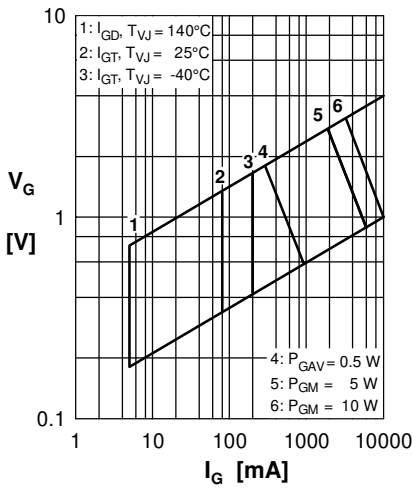

 Fig. 2 Surge overload current
 I_{TSM} : crest value, t : duration

 Fig. 3 I^2t versus time (1-10 s)


Fig. 4 Gate voltage & gate current

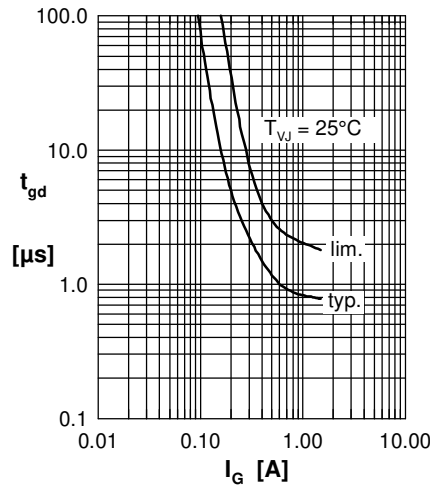
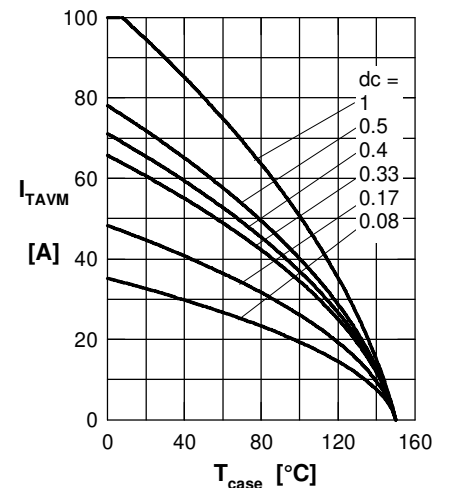

 Fig. 5 Gate controlled delay time t_{gd}


Fig. 6 Max. forward current at case temperature

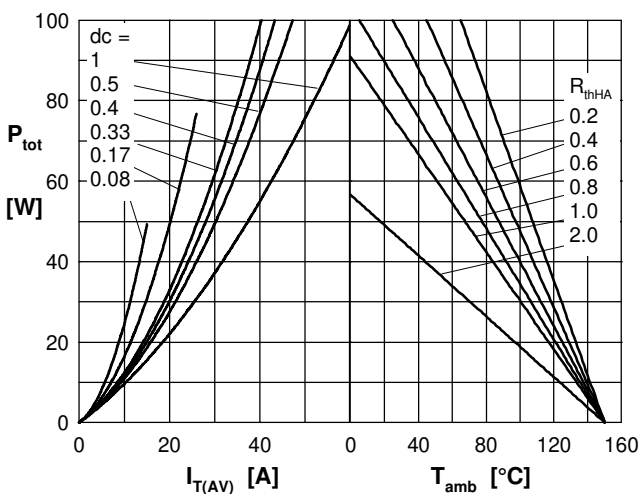
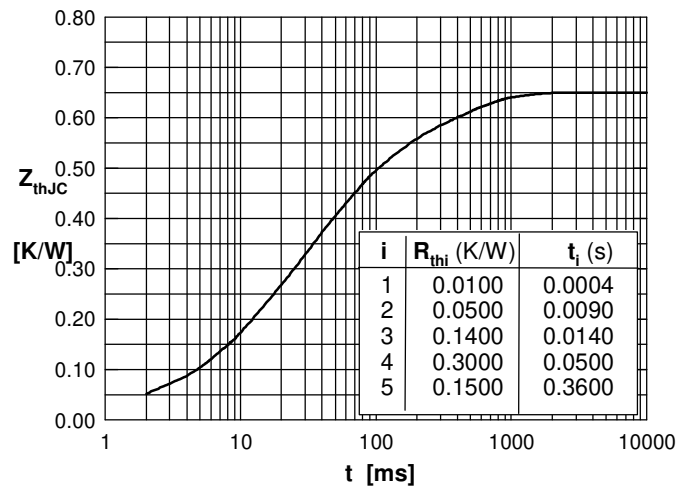

 Fig. 7a Power dissipation versus direct output current
 Fig. 7b and ambient temperature


Fig. 8 Transient thermal impedance junction to case

Brake IGBT + Diode

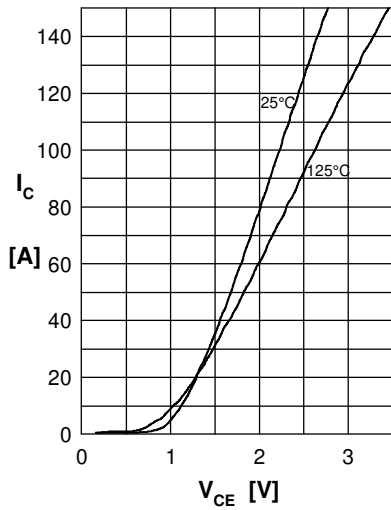


Fig.1 Output characteristics IGBT



Fig.2 Typ. output characteristics IGBT

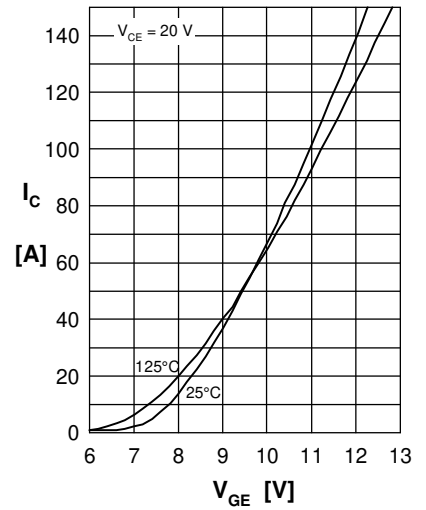


Fig.3 Typ. transfer charact. IGBT

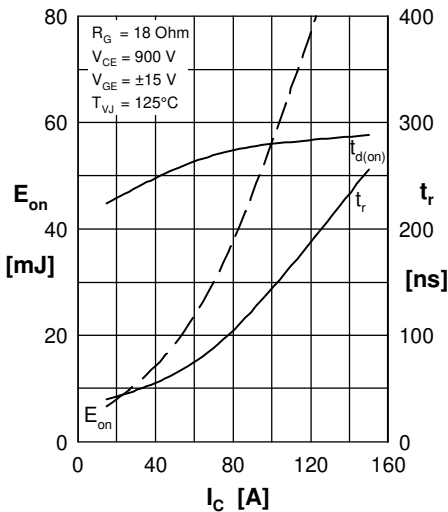


Fig.4 Typ. turn-on energy & switch. times vs. collector current

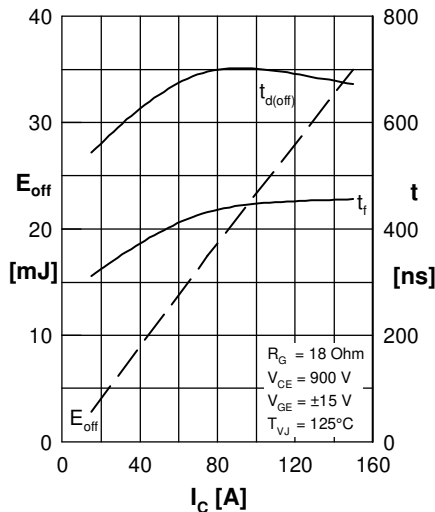


Fig.5 Typ. turn-off energy & switch. times vs. collector current

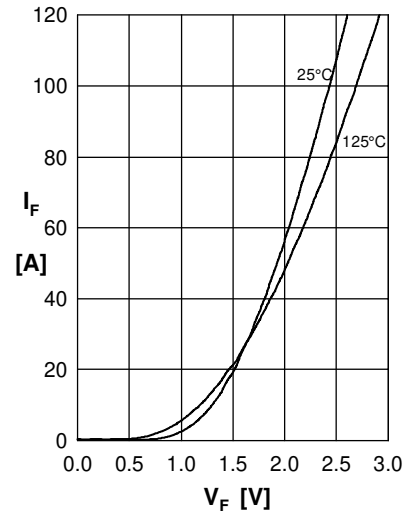


Fig.6 Typ. forward characteristics Diode

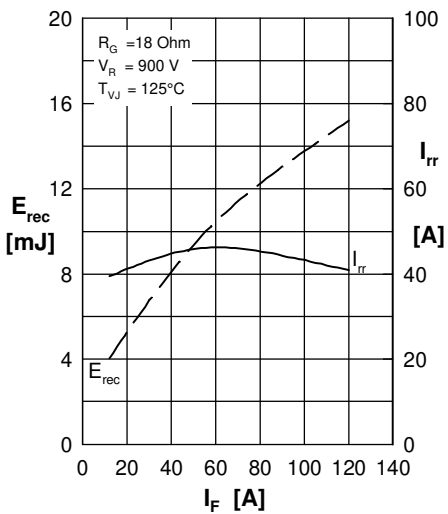


Fig.7 Typ. reverse recovery characteristics Diode

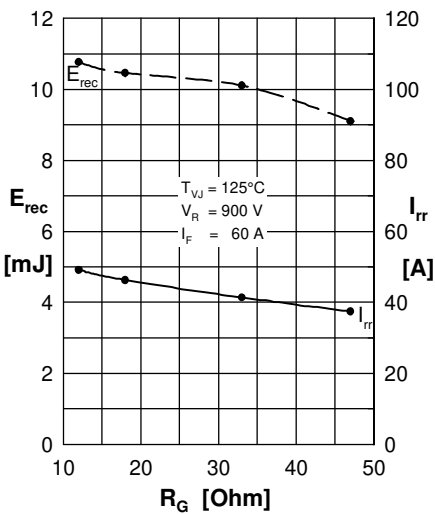


Fig.8 reverse recovery characteristics Diode

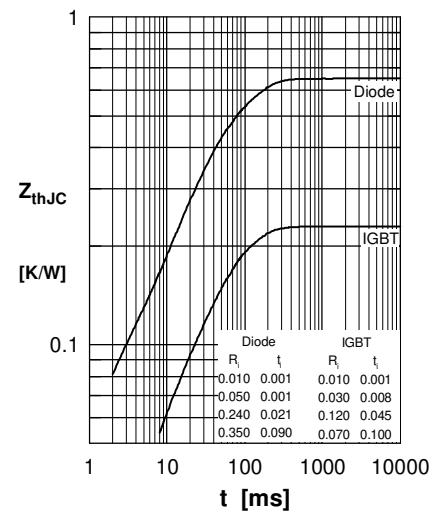


Fig.9 Transient thermal resistance junction to case