

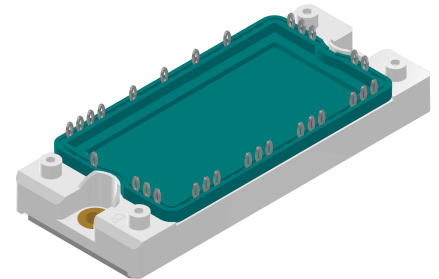
High Voltage Thyristor Module

3~ Rectifier	Brake Chopper
$V_{RRM} = 2200\text{ V}$	$V_{CES} = 1700\text{ V}$
$I_{DAV} = 120\text{ A}$	$I_{C25} = 113\text{ A}$
$I_{FSM} = 500\text{ A}$	$V_{CE(sat)} = 2.5\text{ V}$


3~ Rectifier Bridge, half-controlled (high-side) + Brake Unit

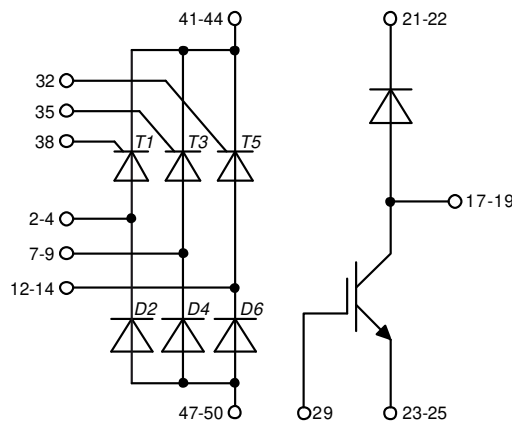
Part number

MCNA120UI2200PED



Backside: isolated

 E72873



Features / Advantages:

- Thyristor/Standard Rectifier for line frequency
- Planar passivated chips
- Long-term stability
- Low forward voltage drop
- Copper base plate with Direct Copper Bonded Al₂O₃-ceramic
- Improved temperature and power cycling

Applications:

- 3~ Rectifier with brake unit for drive inverters

Package: E2-Pack

- Isolation Voltage: 3600 V~
- Industry standard outline
- RoHS compliant
- PressFit-Pins for PCB mounting
- Height: 17 mm
- Base plate: Copper internally DCB isolated
- Advanced power cycling
- Phase Change Material available

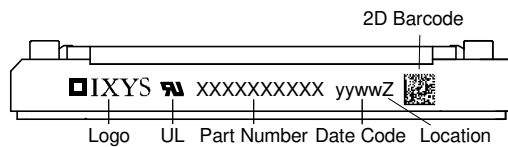
Disclaimer Notice

Information furnished is believed to be accurate and reliable. However, users should independently evaluate the suitability of and test each product selected for their own applications. Littelfuse products are not designed for, and may not be used in, all applications. Read complete Disclaimer Notice at www.littelfuse.com/disclaimer-electronics.



Rectifier				Ratings			
Symbol	Definition	Conditions	min.	typ.	max.	Unit	
$V_{RSM/DSM}$	max. non-repetitive reverse/forward blocking voltage	$T_{VJ} = 25^{\circ}C$			2300	V	
$V_{RRM/DRM}$	max. repetitive reverse/forward blocking voltage	$T_{VJ} = 25^{\circ}C$			2200	V	
I_{RD}	reverse current, drain current	$V_{R/D} = 2200 V$	$T_{VJ} = 25^{\circ}C$		50	μA	
		$V_{R/D} = 2200 V$	$T_{VJ} = 125^{\circ}C$		10	mA	
V_T	forward voltage drop	$I_T = 40 A$	$T_{VJ} = 25^{\circ}C$		1.33	V	
		$I_T = 120 A$			2.05	V	
		$I_T = 40 A$	$T_{VJ} = 125^{\circ}C$		1.36	V	
		$I_T = 120 A$			2.38	V	
I_{DAV}	bridge output current	$T_C = 80^{\circ}C$ rectangular $d = 1/3$	$T_{VJ} = 150^{\circ}C$		120	A	
V_{T0}	threshold voltage	} for power loss calculation only	$T_{VJ} = 150^{\circ}C$		0.83	V	
r_T	slope resistance				13.6	m Ω	
R_{thJC}	thermal resistance junction to case				0.65	K/W	
R_{thCH}	thermal resistance case to heatsink			0.1		K/W	
P_{tot}	total power dissipation		$T_C = 25^{\circ}C$		190	W	
I_{TSM}	max. forward surge current	$t = 10 ms; (50 Hz), sine$	$T_{VJ} = 45^{\circ}C$		500	A	
		$t = 8,3 ms; (60 Hz), sine$	$V_R = 0 V$		540	A	
		$t = 10 ms; (50 Hz), sine$	$T_{VJ} = 150^{\circ}C$		425	A	
		$t = 8,3 ms; (60 Hz), sine$	$V_R = 0 V$		460	A	
I^2t	value for fusing	$t = 10 ms; (50 Hz), sine$	$T_{VJ} = 45^{\circ}C$		1.25	kA ² s	
		$t = 8,3 ms; (60 Hz), sine$	$V_R = 0 V$		1.22	kA ² s	
		$t = 10 ms; (50 Hz), sine$	$T_{VJ} = 150^{\circ}C$		905	A ² s	
		$t = 8,3 ms; (60 Hz), sine$	$V_R = 0 V$		880	A ² s	
C_J	junction capacitance	$V_R = 700 V f = 1 MHz$	$T_{VJ} = 25^{\circ}C$		13	pF	
P_{GM}	max. gate power dissipation	$t_p = 30 \mu s$	$T_C = 150^{\circ}C$		10	W	
		$t_p = 300 \mu s$			5	W	
P_{GAV}	average gate power dissipation				0.5	W	
$(di/dt)_{cr}$	critical rate of rise of current	$T_{VJ} = 150^{\circ}C; f = 50 Hz$ repetitive, $I_T = 120 A$			150	A/ μs	
		$t_p = 200 \mu s; di_G/dt = 0.45 A/\mu s;$ $I_G = 0.45 A; V = 2/3 V_{DRM}$ non-repet., $I_T = 40 A$			500	A/ μs	
$(dv/dt)_{cr}$	critical rate of rise of voltage	$V = 2/3 V_{DRM}$ $R_{GK} = \infty; method 1 (linear voltage rise)$	$T_{VJ} = 150^{\circ}C$		1000	V/ μs	
V_{GT}	gate trigger voltage	$V_D = 6 V$	$T_{VJ} = 25^{\circ}C$		1.4	V	
			$T_{VJ} = -40^{\circ}C$		1.6	V	
I_{GT}	gate trigger current	$V_D = 6 V$	$T_{VJ} = 25^{\circ}C$		70	mA	
			$T_{VJ} = -40^{\circ}C$		150	mA	
V_{GD}	gate non-trigger voltage	$V_D = 2/3 V_{DRM}$	$T_{VJ} = 150^{\circ}C$		0.2	V	
I_{GD}	gate non-trigger current				5	mA	
I_L	latching current	$t_p = 10 \mu s$	$T_{VJ} = 25^{\circ}C$		150	mA	
		$I_G = 0.45 A; di_G/dt = 0.45 A/\mu s$					
I_H	holding current	$V_D = 6 V R_{GK} = \infty$	$T_{VJ} = 25^{\circ}C$		100	mA	
t_{gd}	gate controlled delay time	$V_D = 1/2 V_{DRM}$ $I_G = 0.45 A; di_G/dt = 0.45 A/\mu s$	$T_{VJ} = 25^{\circ}C$		2	μs	
t_q	turn-off time	$V_R = 100 V; I_T = 40 A; V = 2/3 V_{DRM}$ $di/dt = 10 A/\mu s dv/dt = 20 V/\mu s t_p = 200 \mu s$	$T_{VJ} = 125^{\circ}C$	500		μs	

Package E2-Pack		Ratings				
Symbol	Definition	Conditions	min.	typ.	max.	Unit
I_{RMS}	RMS current	per terminal			40	A
T_{VJ}	virtual junction temperature		-40		150	°C
T_{op}	operation temperature		-40		125	°C
T_{stg}	storage temperature		-40		125	°C
Weight				176		g
M_D	mounting torque		3		6	Nm
$d_{Spp/App}$	creepage distance on surface / striking distance through air	terminal to terminal	6.0			mm
$d_{Spb/Appb}$		terminal to backside	12.0			mm
V_{ISOL}	isolation voltage	t = 1 second t = 1 minute	3600 3000			V V
		50/60 Hz, RMS; $I_{ISOL} \leq 1$ mA				



Part description

M = Module
 C = Thyristor (SCR)
 N = High Voltage Thyristor
 A = (>= 2000V)
 120 = Current Rating [A]
 UI = 3- Rectifier Bridge, half-controlled (high-side) + Brake Unit
 2200 = Reverse Voltage [V]
 P = PressFit-Pin
 ED = E2-Pack
 - = Hyphen
 PC = Phase Change Material

Ordering	Ordering Number	Marking on Product	Delivery Mode	Quantity	Code No.
Standard	MCNA120UI2200PED	MCNA120UI2200PED	Blister	28	521435
Alternative	MCNA120UI2200PED-PC	MCNA120UI2200PED	Blister	28	521428

Equivalent Circuits for Simulation

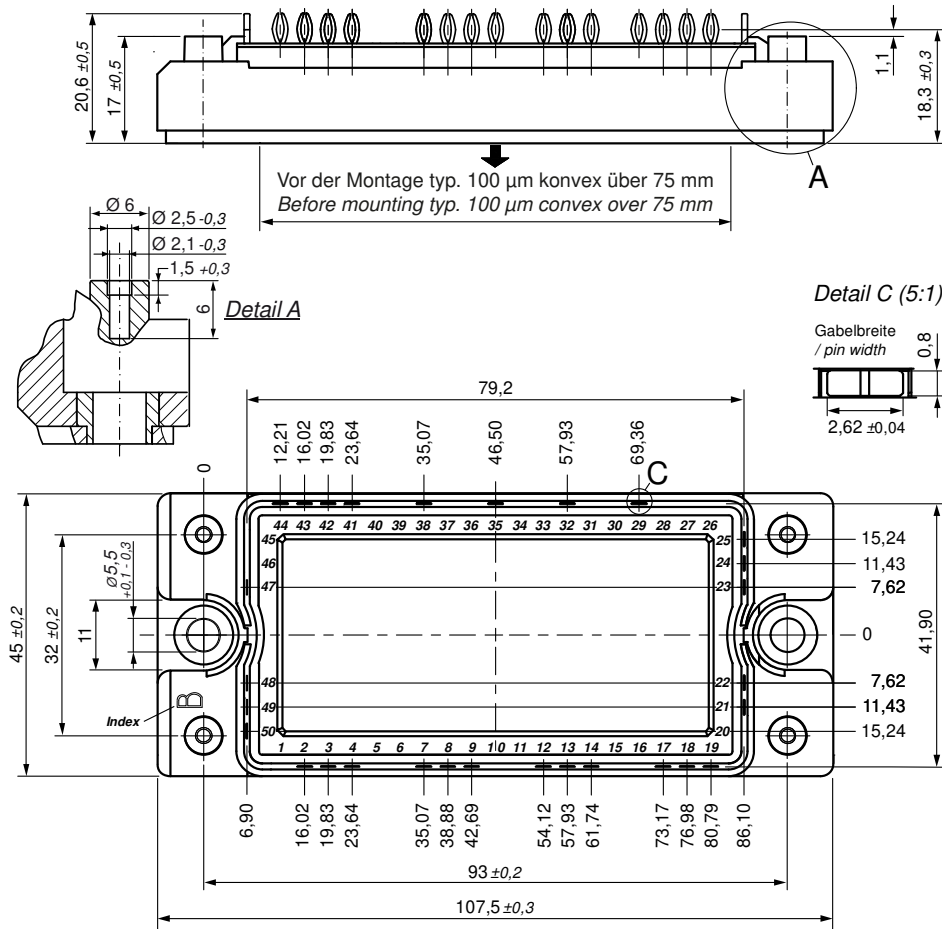
* on die level

$T_{VJ} = 150^{\circ}\text{C}$

		Thyristor	Brake IGBT +	Brake Diode	
V_0	threshold voltage	0.83	1.17	1.34	V
R_0	slope resistance *	10.5	25	15.2	mΩ



Outlines E2-Pack

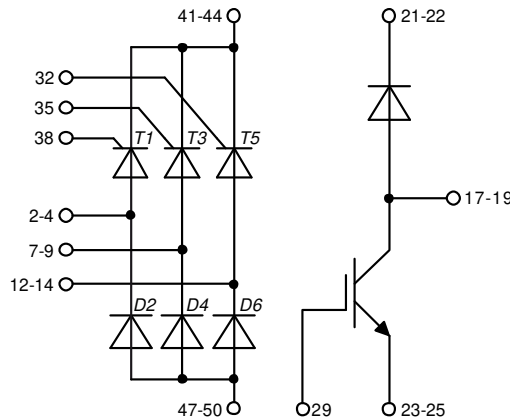


Bemerkung / Note:

- Nicht tolerierte Maße nach / Measure without tolerances according DIN ISO 2768-T1-m
- PCB-Lochmuster / PCB hole pattern: **see pin position**
- Toleranz Pin-Position und PCB-Lochmuster / Tolerance of pin position and PCB hole pattern: $\oplus 0.1$
- Bohrlochdurchmesser / Diameter of drill: **Ø 2.35 mm**
- Endlochdurchmesser / Diameter of plated holes: **Ø 2.14 - 2.29 mm** (Cu thickness in via typ. 50 µm)
- Beschichtung / Plating: **chem. Sn max. 15 µm**
- Einpresskraft / Insert Force: per terminal with a typ. insert speed of 7 mm/s: **typ. 90 N**
- Weitere Angaben / Further information: www.ixys.com **Application note IXAN0077**
- Montageanleitung / Mounting instruction: www.ixys.com **Application note IXAN0024**

Detail A: PCB-Montage / Mounting on PCB^L

- Empfohlene, selbstschneidende Schraube / Recommended, self-tapping screw: **EJOT PT®** (Größe / size: **K25**)^L
- Max. Schraubenlänge / Max. screw length: **PCB-Dicke / thickness + 6 mm** (max. Lochtiefe / hole depth)^L
- Empfohlenes Drehmoment / Recommended mounting torque: **1.5 Nm**



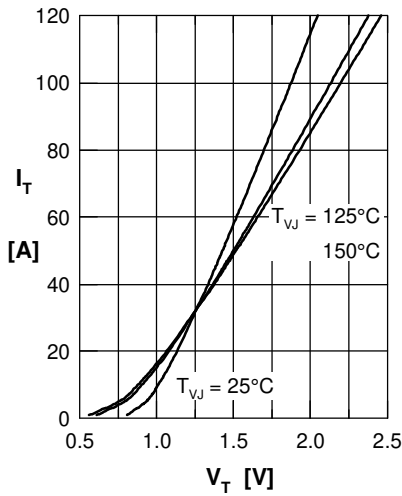
Thyristor


Fig. 1 Forward characteristics

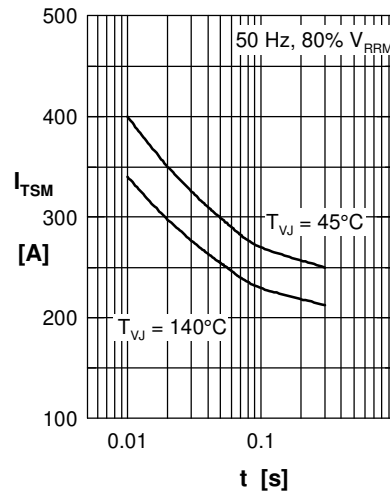
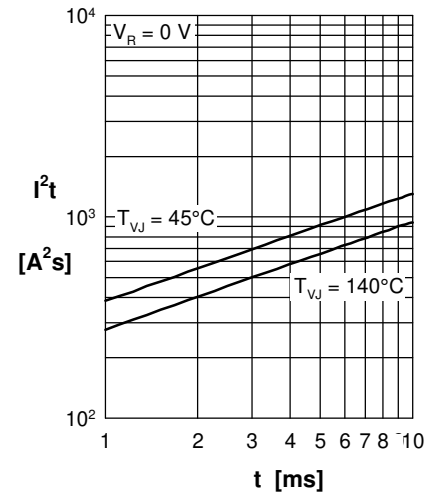
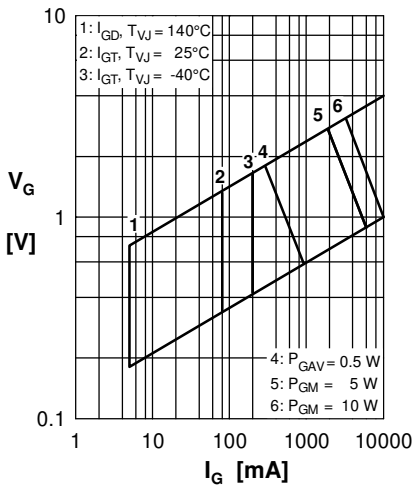

 Fig. 2 Surge overload current
 I_{TSM} : crest value, t : duration

 Fig. 3 I^2t versus time (1-10 s)


Fig. 4 Gate voltage & gate current

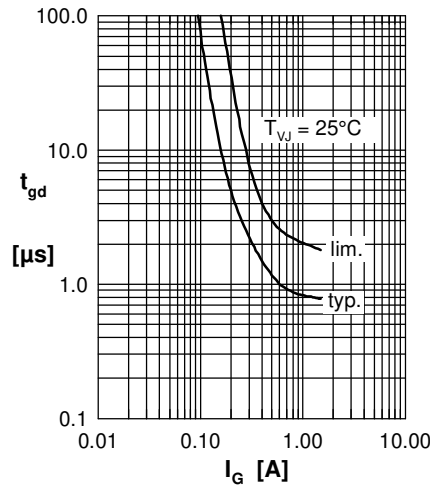
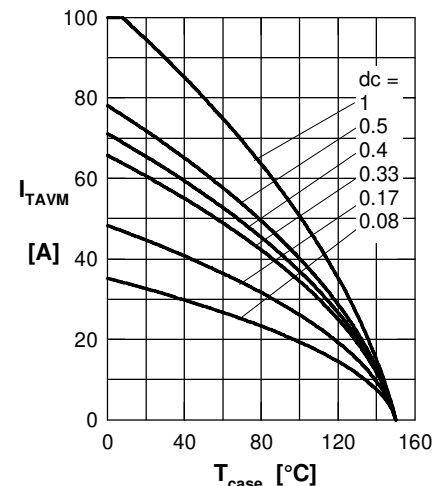

 Fig. 5 Gate controlled delay time t_{gd}


Fig. 6 Max. forward current at case temperature

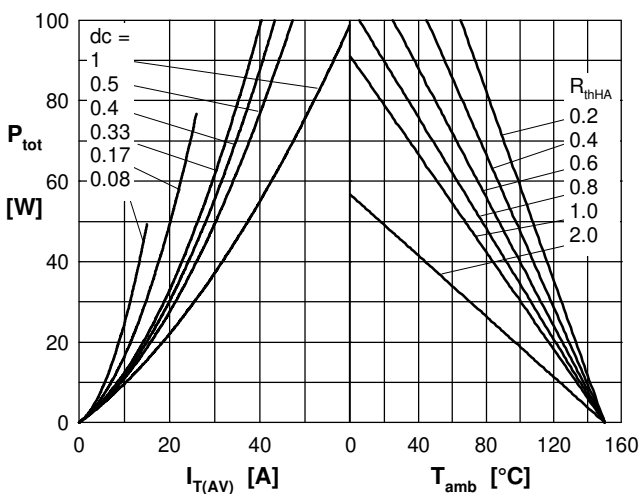
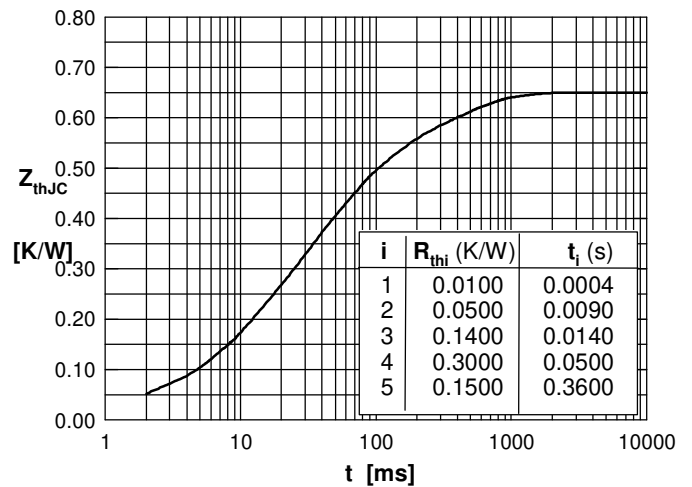

 Fig. 7a Power dissipation versus direct output current
 Fig. 7b and ambient temperature


Fig. 8 Transient thermal impedance junction to case

Brake IGBT + Diode

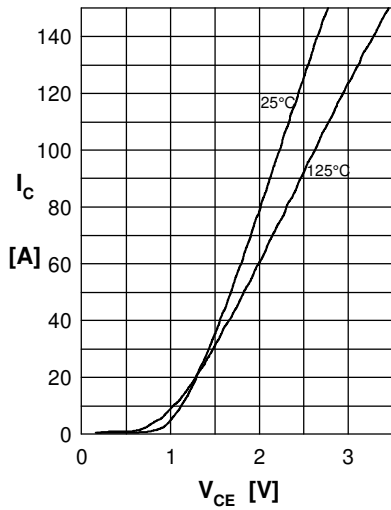


Fig.1 Output characteristics IGBT

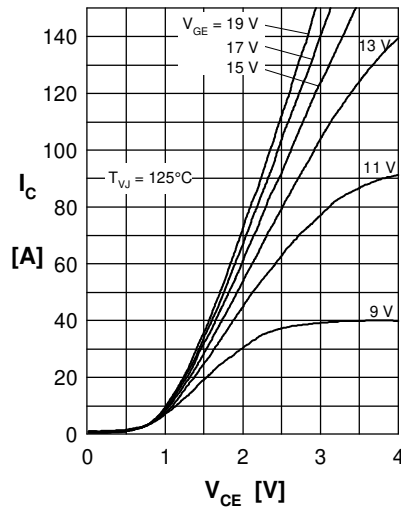


Fig.2 Typ. output characteristics IGBT

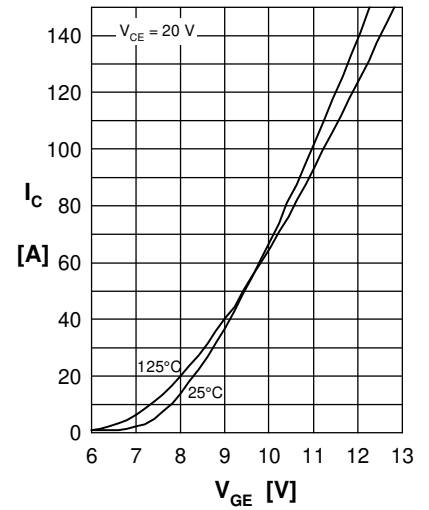


Fig.3 Typ. transfer charact. IGBT

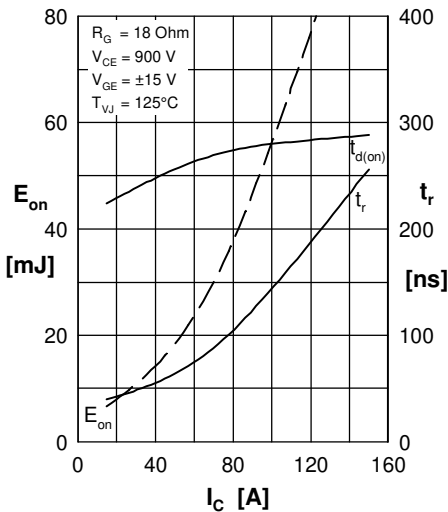


Fig.4 Typ. turn-on energy & switch. times vs. collector current

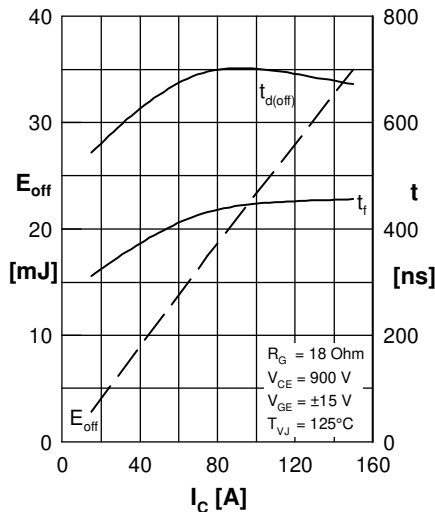


Fig.5 Typ. turn-off energy & switch. times vs. collector current

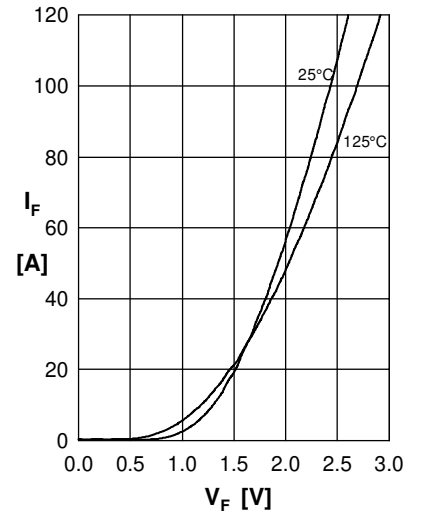


Fig.6 Typ. forward characteristics Diode

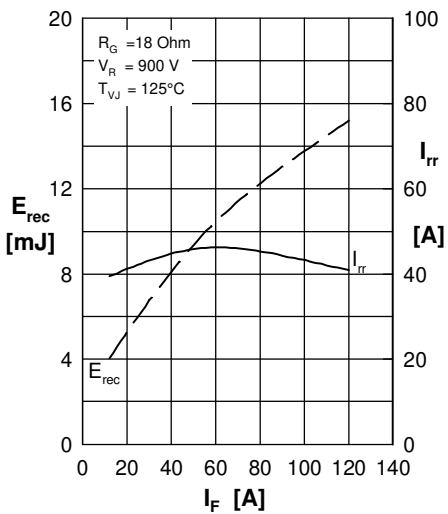


Fig.7 Typ. reverse recovery characteristics Diode

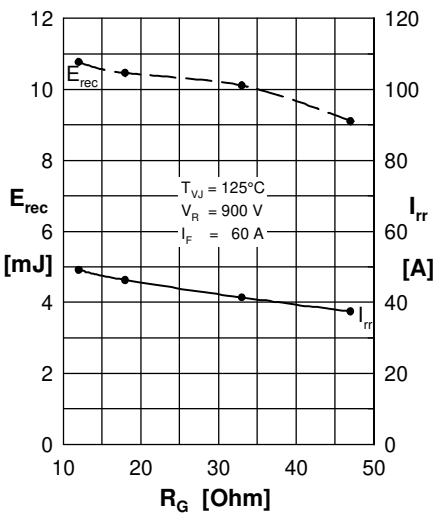


Fig.8 reverse recovery characteristics Diode

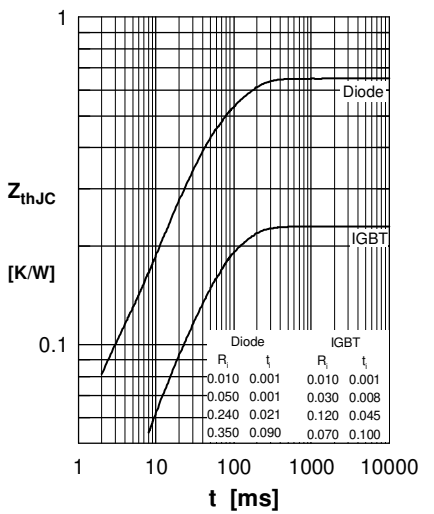


Fig.9 Transient thermal resistance junction to case