

# Thyristor \ Diode Module

$$V_{RRM} = 2 \times 1600 \text{ V}$$

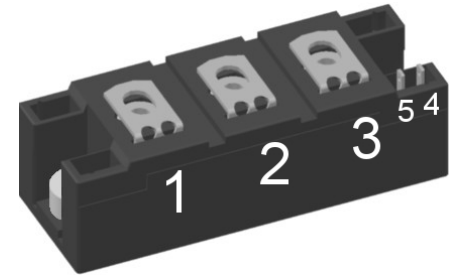
$$I_{TAV} = 181 \text{ A}$$

$$V_T = 1.03 \text{ V}$$


Phase leg

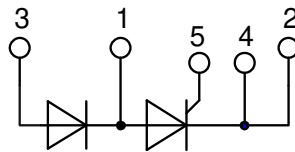
Part number

**MCD162-16io1B**



Backside: isolated

 E72873



### Features / Advantages:

- Thyristor for line frequency
- Planar passivated chip
- Long-term stability
- Direct Copper Bonded Al<sub>2</sub>O<sub>3</sub>-ceramic

### Applications:

- Line rectifying 50/60 Hz
- Softstart AC motor control
- DC Motor control
- Power converter
- AC power control
- Lighting and temperature control

### Package: Y4

- Isolation Voltage: 3600 V~
- Industry standard outline
- RoHS compliant
- Soldering pins for PCB mounting
- Base plate: DCB ceramic
- Reduced weight
- Advanced power cycling

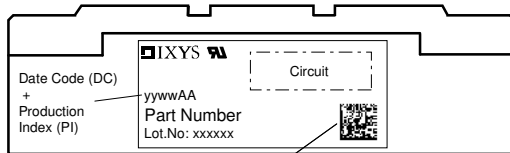
### Disclaimer Notice

Information furnished is believed to be accurate and reliable. However, users should independently evaluate the suitability of and test each product selected for their own applications. Littelfuse products are not designed for, and may not be used in, all applications. Read complete Disclaimer Notice at [www.littelfuse.com/disclaimer-electronics](http://www.littelfuse.com/disclaimer-electronics).

Rectifier			Ratings			
Symbol	Definition	Conditions	min.	typ.	max.	Unit
$V_{RSM/DSM}$	max. non-repetitive reverse/forward blocking voltage	$T_{VJ} = 25^{\circ}C$			1700	V
$V_{RRM/DRM}$	max. repetitive reverse/forward blocking voltage	$T_{VJ} = 25^{\circ}C$			1600	V
$I_{RD}$	reverse current, drain current	$V_{R/D} = 1600\text{ V}$	$T_{VJ} = 25^{\circ}C$		300	$\mu A$
		$V_{R/D} = 1600\text{ V}$	$T_{VJ} = 125^{\circ}C$		10	mA
$V_T$	forward voltage drop	$I_T = 150\text{ A}$	$T_{VJ} = 25^{\circ}C$		1.09	V
		$I_T = 300\text{ A}$			1.25	V
		$I_T = 150\text{ A}$	$T_{VJ} = 125^{\circ}C$		1.03	V
		$I_T = 300\text{ A}$			1.25	V
$I_{TAV}$	average forward current	$T_C = 85^{\circ}C$	$T_{VJ} = 125^{\circ}C$		181	A
$I_{T(RMS)}$	RMS forward current	180° sine			300	A
$V_{T0}$	threshold voltage	} for power loss calculation only	$T_{VJ} = 125^{\circ}C$		0.88	V
$r_T$	slope resistance				1.15	m $\Omega$
$R_{thJC}$	thermal resistance junction to case				0.155	K/W
$R_{thCH}$	thermal resistance case to heatsink			0.07		K/W
$P_{tot}$	total power dissipation		$T_C = 25^{\circ}C$		645	W
$I_{TSM}$	max. forward surge current	$t = 10\text{ ms}; (50\text{ Hz}), \text{ sine}$	$T_{VJ} = 45^{\circ}C$		6.00	kA
		$t = 8,3\text{ ms}; (60\text{ Hz}), \text{ sine}$	$V_R = 0\text{ V}$		6.48	kA
		$t = 10\text{ ms}; (50\text{ Hz}), \text{ sine}$	$T_{VJ} = 125^{\circ}C$		5.10	kA
		$t = 8,3\text{ ms}; (60\text{ Hz}), \text{ sine}$	$V_R = 0\text{ V}$		5.51	kA
$I^2t$	value for fusing	$t = 10\text{ ms}; (50\text{ Hz}), \text{ sine}$	$T_{VJ} = 45^{\circ}C$		180.0	kA <sup>2</sup> s
		$t = 8,3\text{ ms}; (60\text{ Hz}), \text{ sine}$	$V_R = 0\text{ V}$		174.7	kA <sup>2</sup> s
		$t = 10\text{ ms}; (50\text{ Hz}), \text{ sine}$	$T_{VJ} = 125^{\circ}C$		130.1	kA <sup>2</sup> s
		$t = 8,3\text{ ms}; (60\text{ Hz}), \text{ sine}$	$V_R = 0\text{ V}$		126.3	kA <sup>2</sup> s
$C_J$	junction capacitance	$V_R = 400\text{ V}$ $f = 1\text{ MHz}$	$T_{VJ} = 25^{\circ}C$		273	pF
$P_{GM}$	max. gate power dissipation	$t_p = 30\text{ }\mu s$	$T_C = 125^{\circ}C$		120	W
		$t_p = 500\text{ }\mu s$			60	W
$P_{GAV}$	average gate power dissipation				8	W
$(di/dt)_{cr}$	critical rate of rise of current	$T_{VJ} = 125^{\circ}C; f = 50\text{ Hz}$ repetitive, $I_T = 540\text{ A}$			150	A/ $\mu s$
		$t_p = 200\text{ }\mu s; di_G/dt = 0.5\text{ A}/\mu s;$ $I_G = 0.5\text{ A}; V = \frac{2}{3} V_{DRM}$ non-repet., $I_T = 180\text{ A}$			500	A/ $\mu s$
$(dv/dt)_{cr}$	critical rate of rise of voltage	$V = \frac{2}{3} V_{DRM}$ $R_{GK} = \infty; \text{ method 1 (linear voltage rise)}$	$T_{VJ} = 125^{\circ}C$		1000	V/ $\mu s$
$V_{GT}$	gate trigger voltage	$V_D = 6\text{ V}$	$T_{VJ} = 25^{\circ}C$		2.5	V
			$T_{VJ} = -40^{\circ}C$		2.6	V
$I_{GT}$	gate trigger current	$V_D = 6\text{ V}$	$T_{VJ} = 25^{\circ}C$		150	mA
			$T_{VJ} = -40^{\circ}C$		200	mA
$V_{GD}$	gate non-trigger voltage	$V_D = \frac{2}{3} V_{DRM}$	$T_{VJ} = 125^{\circ}C$		0.2	V
$I_{GD}$	gate non-trigger current				10	mA
$I_L$	latching current	$t_p = 30\text{ }\mu s$	$T_{VJ} = 25^{\circ}C$		300	mA
		$I_G = 0.5\text{ A}; di_G/dt = 0.5\text{ A}/\mu s$				
$I_H$	holding current	$V_D = 6\text{ V}$ $R_{GK} = \infty$	$T_{VJ} = 25^{\circ}C$		200	mA
$t_{gd}$	gate controlled delay time	$V_D = \frac{1}{2} V_{DRM}$	$T_{VJ} = 25^{\circ}C$		2	$\mu s$
		$I_G = 0.5\text{ A}; di_G/dt = 0.5\text{ A}/\mu s$				
$t_q$	turn-off time	$V_R = 100\text{ V}; I_T = 300\text{ A}; V = \frac{2}{3} V_{DRM}$ $di/dt = 10\text{ A}/\mu s$ $dv/dt = 20\text{ V}/\mu s$ $t_p = 200\text{ }\mu s$	$T_{VJ} = 100^{\circ}C$		150	$\mu s$



Package Y4				Ratings			
Symbol	Definition	Conditions	min.	typ.	max.	Unit	
$I_{RMS}$	RMS current	per terminal			300	A	
$T_{VJ}$	virtual junction temperature		-40		125	°C	
$T_{op}$	operation temperature		-40		100	°C	
$T_{stg}$	storage temperature		-40		125	°C	
<b>Weight</b>					150	g	
$M_D$	mounting torque		2.25		2.75	Nm	
$M_T$	terminal torque		4.5		5.5	Nm	
$d_{Spp/Apb}$	creepage distance on surface   striking distance through air	terminal to terminal	14.0	10.0		mm	
$d_{Spb/Apb}$		terminal to backside	16.0	16.0		mm	
$V_{ISOL}$	isolation voltage	t = 1 second			3600	V	
		t = 1 minute	50/60 Hz, RMS; $I_{ISOL} \leq 1$ mA		3000	V	



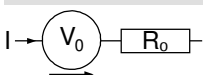
Data Matrix: part no. (1-19), DC + PI (20-25), lot.no.# (26-31), blank (32), serial no.# (33-36)

Ordering	Ordering Number	Marking on Product	Delivery Mode	Quantity	Code No.
Standard	MCD162-16io1B	MCD162-16io1B	Box	6	510235

**Equivalent Circuits for Simulation**

\* on die level

$T_{VJ} = 125$  °C

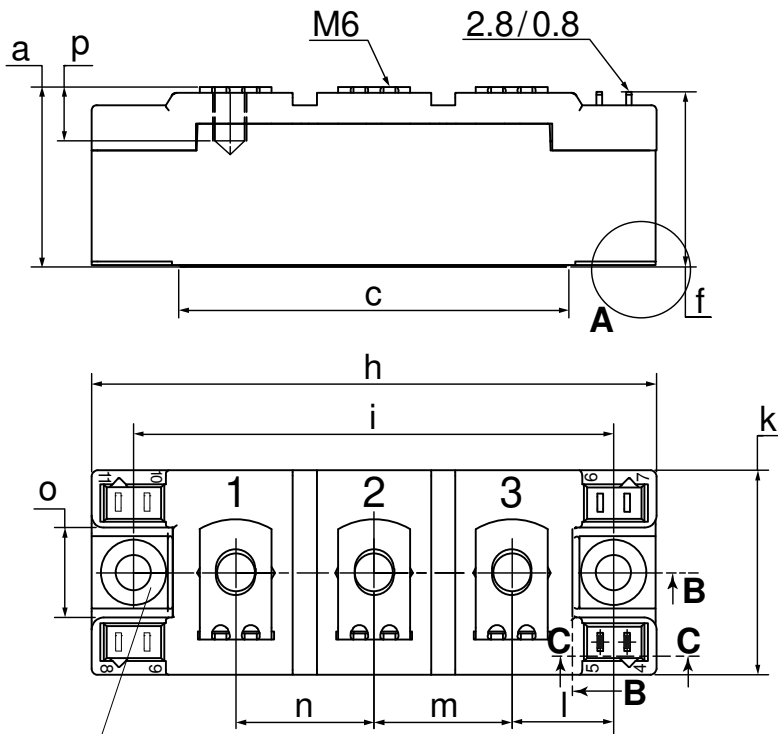


**Thyristor**

$V_{0\ max}$	threshold voltage	0.88	V
$R_{0\ max}$	slope resistance *	0.8	mΩ

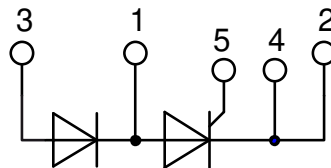
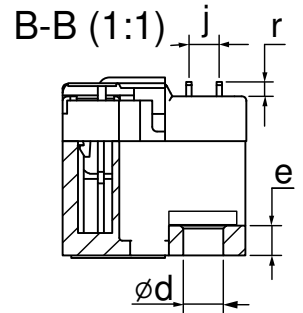
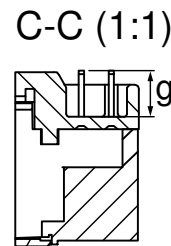
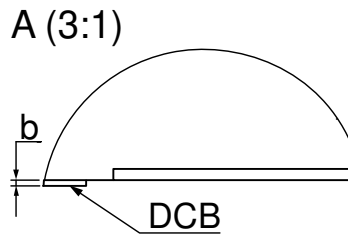
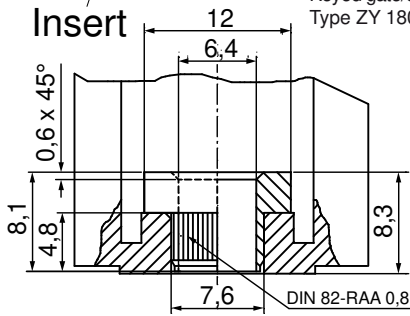


**Outlines Y4**



Dim.	MIN [mm]	MAX [mm]	MIN [inch]	MAX [inch]
a	30.0	30.6	1.181	1.205
b	typ. 0.25		typ. 0.010	
c	64.0	65.0	2.520	2.559
d	typ. 6.4		typ. 0.250	
e	4.9	5.1	0.193	0.201
f	28.6	29.2	1.126	1.150
g	7.3	7.7	0.287	0.303
h	93.5	94.5	3.681	3.720
i	79.5	80.5	3.130	3.169
j	4.8	5.2	0.189	0.205
k	33.4	34.0	1.315	1.339
l	16.7	17.3	0.657	0.681
m	22.7	23.3	0.894	0.917
n	22.7	23.3	0.894	0.917
o	14.0	15.0	0.551	0.591
p	typ. 10.5		typ. 0.413	
r	1.8	2.4	0.071	0.041

Optional accessories for modules  
Keyed gate/cathode twin plugs with wire length = 350 mm, gate = white, cathode = red  
Type ZY 180L (L = Left for pin pair 4/5) UL 758, style 3751



**Thyristor**

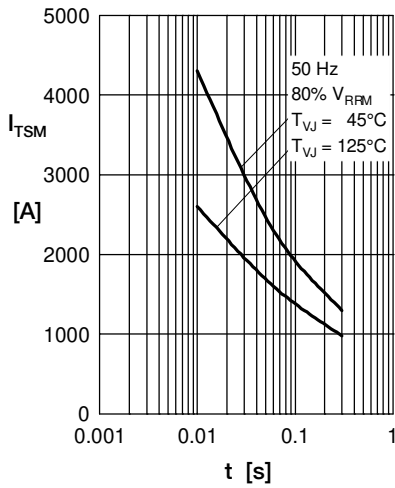


Fig. 1 Surge overload current  $I_{TSM}$ ,  $I_{FSM}$ : Crest value,  $t$ : duration

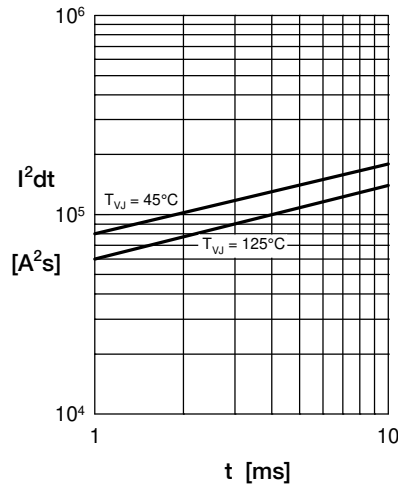


Fig. 2  $I^2dt$  versus time (1-10 ms)

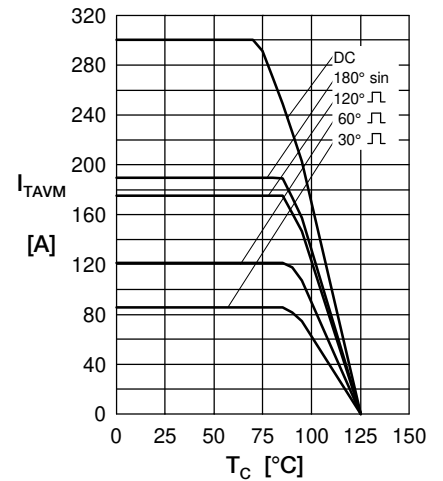


Fig. 3 Max. forward current at case temperature

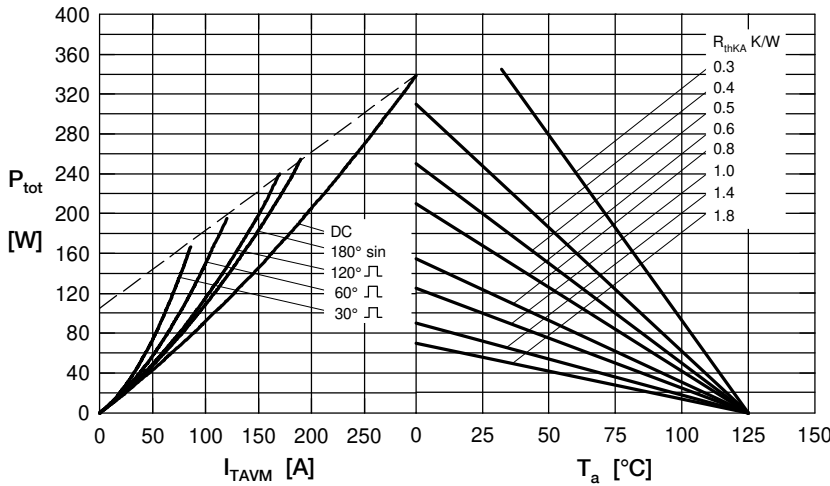


Fig. 4 Power dissipation vs. on-state current & ambient temperature (per thyristor or diode)

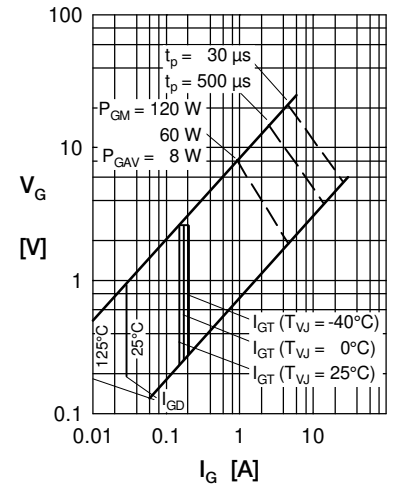


Fig. 5 Gate trigger characteristics

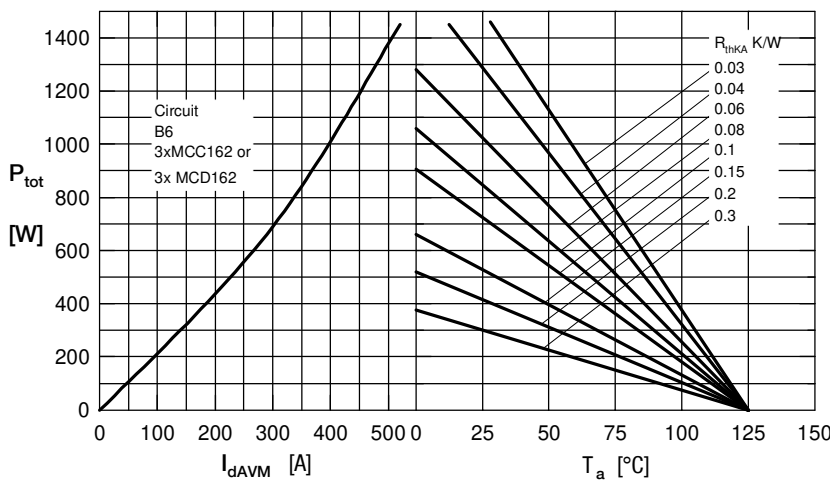


Fig. 6 Three phase rectifier bridge: Power dissipation versus direct output current and ambient temperature

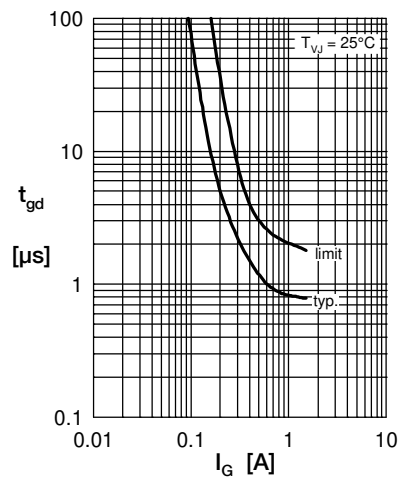


Fig. 7 Gate trigger delay time

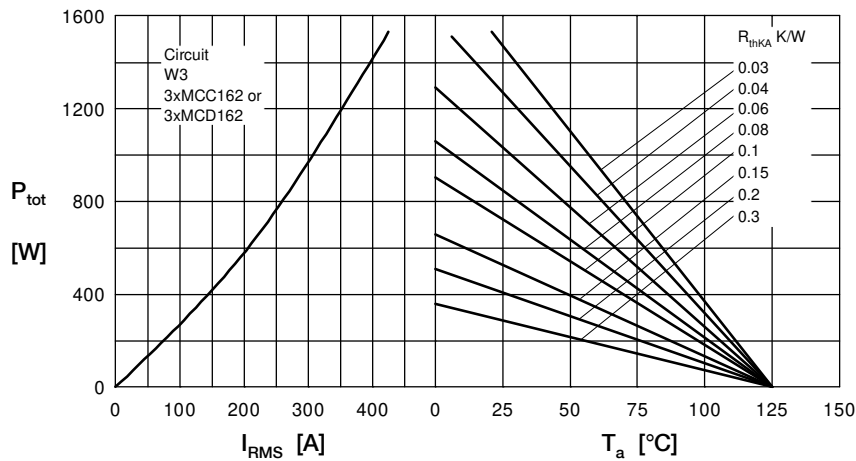
**Rectifier**


Fig. 8 Three phase AC-controller: Power dissipation versus RMS output current and ambient temperature

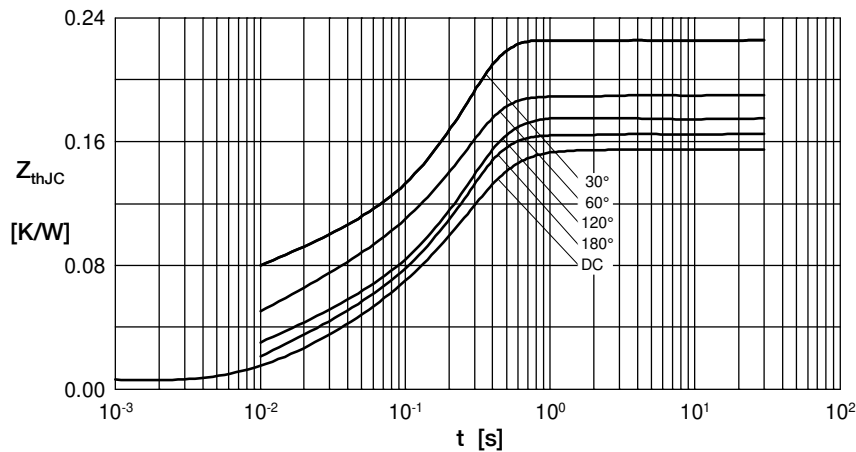


Fig. 9 Transient thermal impedance junction to case (per thyristor/diode)

$R_{thJC}$  for various conduction angles  $d$ :

$d$	$R_{thJC}$ [K/W]
DC	0.155
180°	0.167
120°	0.176
60°	0.197
30°	0.227

Constants for  $Z_{thJC}$  calculation:

$i$	$R_{thi}$ [K/W]	$t_i$ [s]
1	0.0072	0.001
2	0.0188	0.080
3	0.1290	0.200

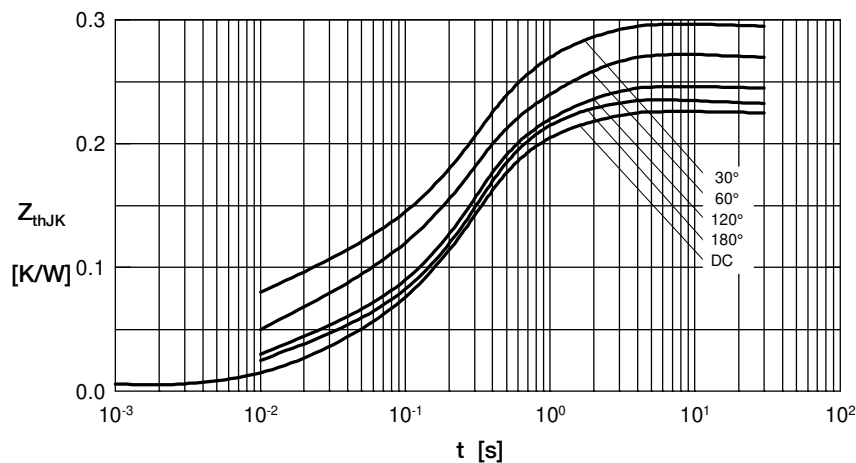


Fig. 10 Transient thermal impedance junction to heatsink (per thyristor/diode)

$R_{thJK}$  for various conduction angles  $d$ :

$d$	$R_{thJK}$ [K/W]
DC	0.225
180°	0.237
120°	0.246
60°	0.267
30°	0.297

Constants for  $Z_{thJK}$  calculation:

$i$	$R_{thi}$ [K/W]	$t_i$ [s]
1	0.0072	0.001
2	0.0188	0.080
3	0.1290	0.200
4	0.0700	1.000