

Thyristor Modules

$$I_{TRMS} = 2 \times 300 \text{ A}$$

$$I_{TAVM} = 2 \times 190 \text{ A}$$

$$V_{RRM} = 1400\text{-}1800 \text{ V}$$

V_{RSM}	V_{RRM}	Type
V_{DSM}	V_{DRM}	
V	V	
1500	1400	MCC 162-14io1B
1700	1600	MCC 162-16io1B
1900	1800	MCC 162-18io1B
1700	1600	MCD 162-16io1B

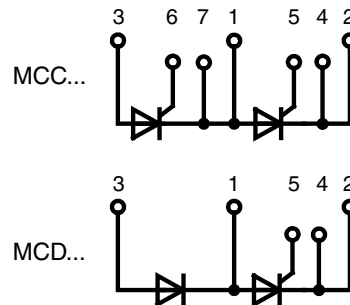

MCD... version without pins 6 & 7

Symbol	Conditions	Maximum Ratings
I_{TRMS}	$T_{VJ} = T_{VJM}$	300 A
I_{TAVM}	$T_C = 80^\circ\text{C}$; 180° sine	190 A
	$T_C = 85^\circ\text{C}$; 180° sine	181 A
I_{TSM}	$T_{VJ} = 45^\circ\text{C}$; $t = 10 \text{ ms}$ (50 Hz)	6000 A
	$V_R = 0$; $t = 8.3 \text{ ms}$ (60 Hz)	6400 A
	$T_{VJ} = T_{VJM}$; $t = 10 \text{ ms}$ (50 Hz)	5250 A
	$V_R = 0$; $t = 8.3 \text{ ms}$ (60 Hz)	6500 A
I^2t	$T_{VJ} = 45^\circ\text{C}$; $t = 10 \text{ ms}$ (50 Hz)	180 000 A ² s
	$V_R = 0$; $t = 8.3 \text{ ms}$ (60 Hz)	170 000 A ² s
	$T_{VJ} = T_{VJM}$; $t = 10 \text{ ms}$ (50 Hz)	137 000 A ² s
	$V_R = 0$; $t = 8.3 \text{ ms}$ (60 Hz)	128 000 A ² s
$(di/dt)_{cr}$	$T_{VJ} = T_{VJM}$; repetitive, $I_T = 500 \text{ A}$ $f = 50 \text{ Hz}$; $t_p = 200 \mu\text{s}$;	150 A/ μs
	$V_D = \frac{2}{3} V_{DRM}$; $I_G = 0.5 \text{ A}$; $di_G/dt = 0.5 \text{ A}/\mu\text{s}$ non repetitive, $I_T = 500 \text{ A}$	500 A/ μs
$(dv/dt)_{cr}$	$T_{VJ} = T_{VJM}$; $V_D = \frac{2}{3} V_{DRM}$; $R_{GK} = \infty$; method 1 (linear voltage rise)	1000 V/ μs
P_{GM}	$T_{VJ} = T_{VJM}$; $t_p = 30 \mu\text{s}$	120 W
	$I_T = I_{T(AV)M}$; $t_p = 500 \mu\text{s}$	60 W
P_{GAV}		8 W
V_{RGM}		10 V
T_{VJ}		-40...+125 °C
T_{VJM}		125 °C
T_{stg}		-40...+125 °C
V_{ISOL}	50/60 Hz, RMS $t = 1 \text{ min}$	3000 V~
	$I_{ISOL} \leq 1 \text{ mA}$ $t = 1 \text{ s}$	3600 V~
M_d	Mounting torque (M5)	4 - 5 Nm
	Mounting torque (M6)	4 - 5 Nm
	Terminal connection torque (M6)	4.5 - 5.5 Nm
Weight	Typical including screws	125 g

Data according to IEC 60747 and refer to a single diode unless otherwise stated.

IXYS reserves the right to change limits, test conditions and dimensions.

20160411e

Features

- International standard package
- Direct copper bonded Al_2O_3 -ceramic base plate
- Planar passivated chips
- Isolation voltage 3600 V~
- UL registered, E 72873
- Keyed gate/cathode twin pins

Applications

- Motor control
- Power converter
- Heat and temperature control for industrial furnaces and chemical processes
- Lighting control
- Contactless switches

Advantages

- Space and weight savings
- Simple mounting
- Improved temperature and power cycling
- Reduced protection circuits

Symbol	Conditions	Characteristic Values	
		typ.	max.
I_{RRM}, I_{DRM}	$V_R / V_D = V_{RRM} / V_{DRM}$	$T_{VJ} = T_{VJM}$	10 mA
V_T	$I_T = 300 \text{ A}$	$T_{VJ} = 25^\circ\text{C}$	1.25 V
V_{T0}	For power-loss calculations only		0.88 V
r_t		$T_{VJ} = T_{VJM}$	1.15 mΩ
V_{GT}	$V_D = 6 \text{ V}$	$T_{VJ} = 25^\circ\text{C}$	2.5 V
		$T_{VJ} = -40^\circ\text{C}$	2.6 V
I_{GT}	$V_D = 6 \text{ V}$	$T_{VJ} = 25^\circ\text{C}$	150 mA
		$T_{VJ} = -40^\circ\text{C}$	200 mA
V_{GD}	$V_D = \frac{2}{3} V_{DRM}$	$T_{VJ} = T_{VJM}$	0.2 V
I_{GD}			10 mA
I_L	$t_p = 30 \mu\text{s}; V_D = 6 \text{ V}$ $I_G = 0.5 \text{ A}; di_G/dt = 0.5 \text{ A}/\mu\text{s}$	$T_{VJ} = 25^\circ\text{C}$	300 mA
I_H	$V_D = 6 \text{ V}; R_{GK} = \infty;$	$T_{VJ} = 25^\circ\text{C}$	200 mA
t_{gd}	$V_D = \frac{1}{2} V_{DRM}$ $I_G = 0.5 \text{ A}; di_G/dt = 20 \text{ A}/\mu\text{s}$	$T_{VJ} = 25^\circ\text{C}$	2 μs
t_q	$V_D = \frac{2}{3} V_{DRM}$ $dv/dt = 20 \text{ V}/\mu\text{s}; -di/dt = 10 \text{ A}/\mu\text{s}$ $I_T = 160 \text{ A}; V_R = 100 \text{ V}; t_p = 200 \mu\text{s}$	$T_{VJ} = T_{VJM}$	150 μs
Q_S	$I_T = 300 \text{ A}; -di/dt = 50 \text{ A}/\mu\text{s}$	$T_{VJ} = T_{VJM}$	550 μC
I_{RM}			235 A
R_{thJC}	per thyristor; DC current per module	} other values see Fig. 8/9	0.155 K/W
R_{thJK}	per thyristor; DC current per module		0.0775 K/W
			0.255 K/W
			0.1125 K/W
d_s	Creeping distance on surface		12.7 mm
d_A	Creepage distance in air		9.6 mm
a	Maximum allowable acceleration		50 m/s ²

Optional accessories for modules

Keyed gate/cathode twin plugs with wire length = 350 mm, gate = yellow, cathode = red

Type **ZY 180L** (L = Left for pin pair 4/5) } UL 758, style 1385,
 Type **ZY 180R** (R = right for pin pair 6/7) } CSA class 5851, guide 460-1-1

MCC... MCD... w/o pins 6 and 7

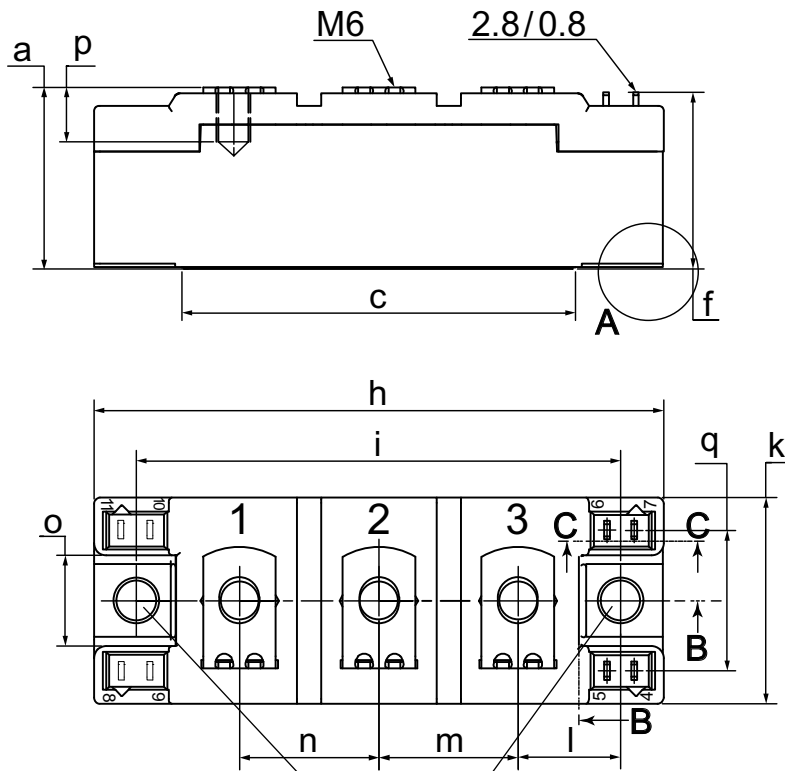

Dim.	MIN [mm]	MIN [mm]	MIN [inch]	MIN [inch]
a	30.0	30.6	1.181	1.205
b	typ. 0.25		typ. 0.010	
c	64.0	65.0	2.520	2.559
d	6.5	7.0	0.256	0.275
e	4.9	5.1	0.193	0.201
f	28.6	29.2	1.126	1.150
g	7.3	7.7	0.287	0.303
h	93.5	94.5	3.681	3.720
i	79.5	80.5	3.130	3.169
j	4.8	5.2	0.189	0.205
k	33.4	34.0	1.315	1.339
l	16.7	17.3	0.657	0.681
m	22.7	23.3	0.894	0.917
n	22.7	23.3	0.894	0.917
o	14.0	15.0	0.551	0.591
p	typ. 10.5		typ. 0.413	
q	22.8	23.3	0.898	0.917
r	1.8	2.4	0.071	0.041

A (3:1)

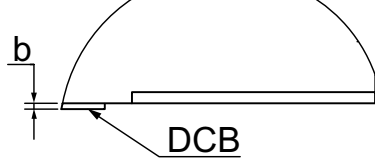

B-B (1:1)

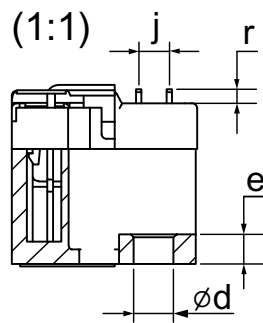

C-C (1:1)

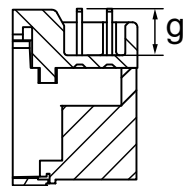

Plug socket

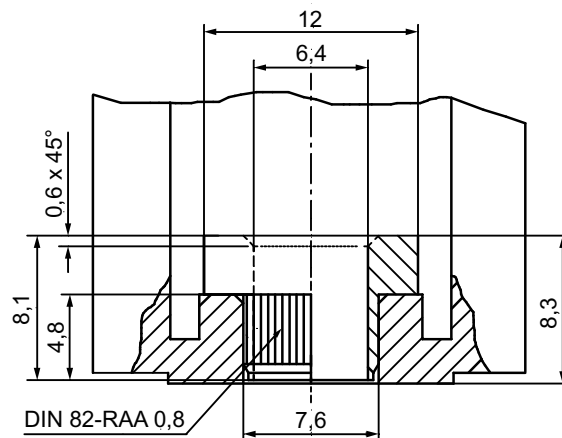

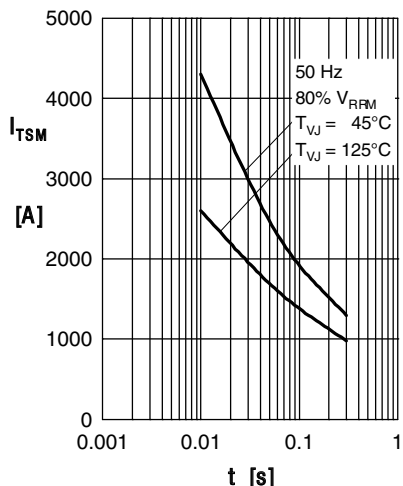

Fig. 1 Surge overload current I_{TSM} ,
 I_{FSM} : Crest value, t: duration

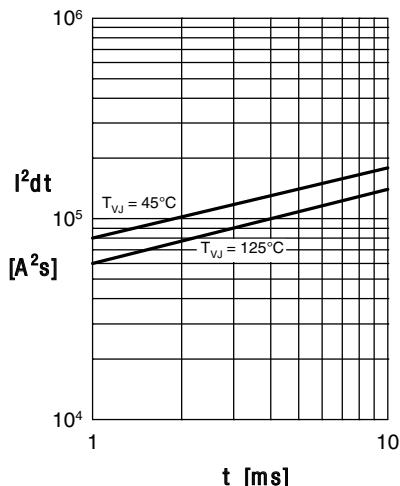

Fig. 2 I^2t versus time (1-10 ms)

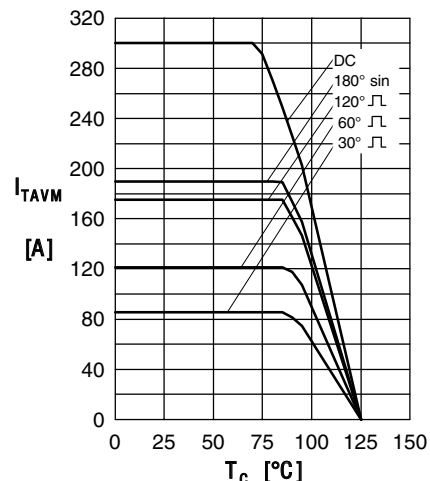

Fig. 3 Max. forward current at case temperature

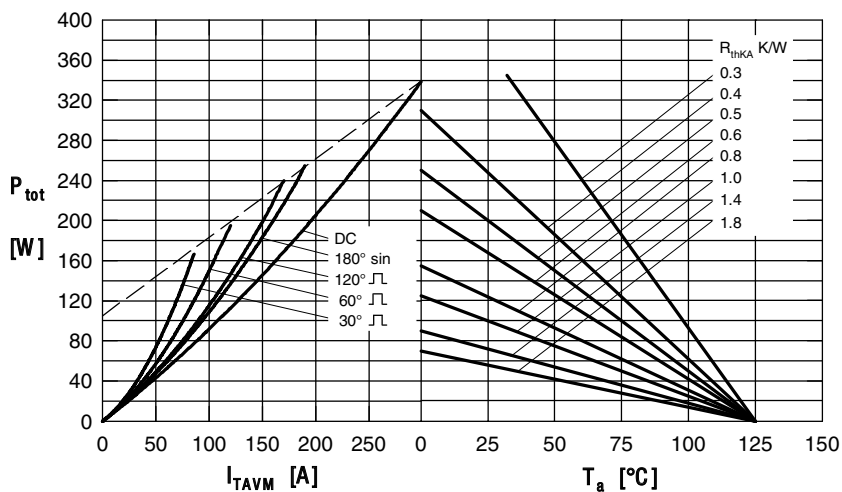

Fig. 4 Power dissipation vs. on-state current & ambient temperature (per thyristor or diode)

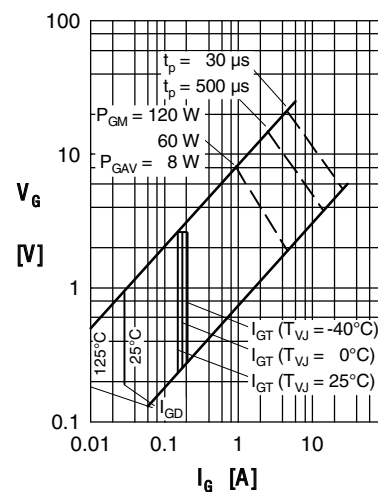

Fig. 5 Gate trigger characteristics

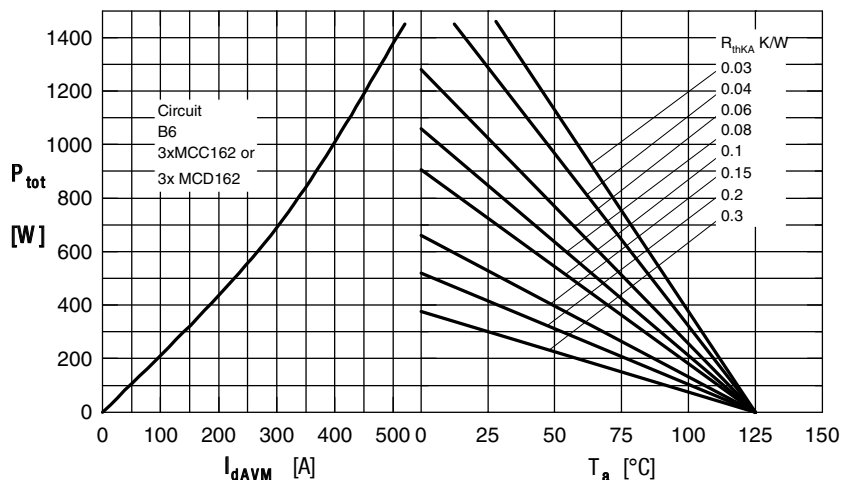

Fig. 6 Three phase rectifier bridge: Power dissipation versus direct output current and ambient temperature

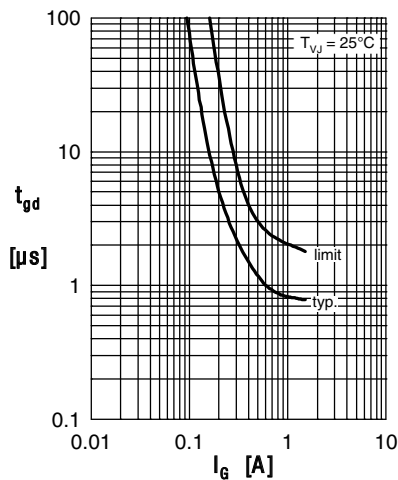

Fig. 7 Gate trigger delay time

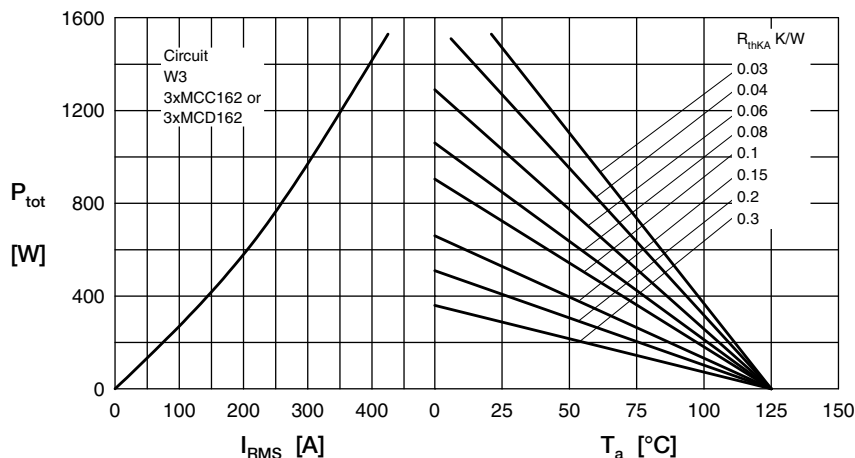

Fig. 8 Three phase AC-controller: Power dissipation versus RMS output current and ambient temperature

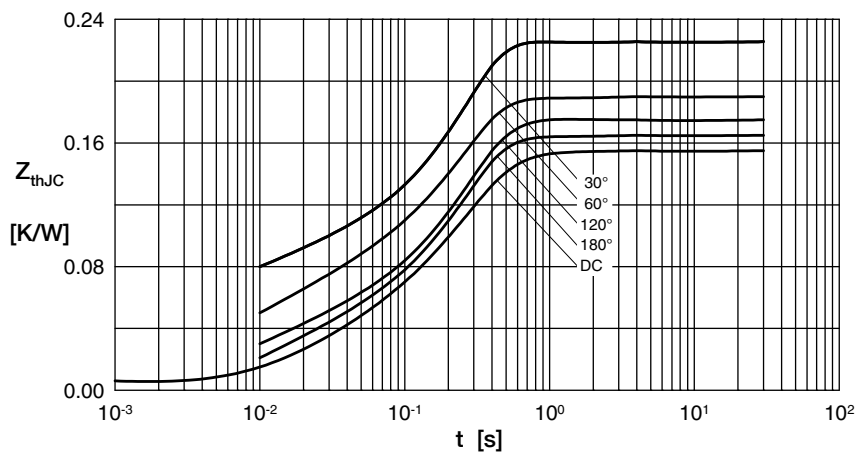

Fig. 9 Transient thermal impedance junction to case (per thyristor/diode)

R_{thJC} for various conduction angles d:

d	R_{thJC} [K/W]
DC	0.155
180°	0.167
120°	0.176
60°	0.197
30°	0.227

Constants for Z_{thJC} calculation:

i	R_{thi} [K/W]	t_i [s]
1	0.0072	0.001
2	0.0188	0.080
3	0.1290	0.200

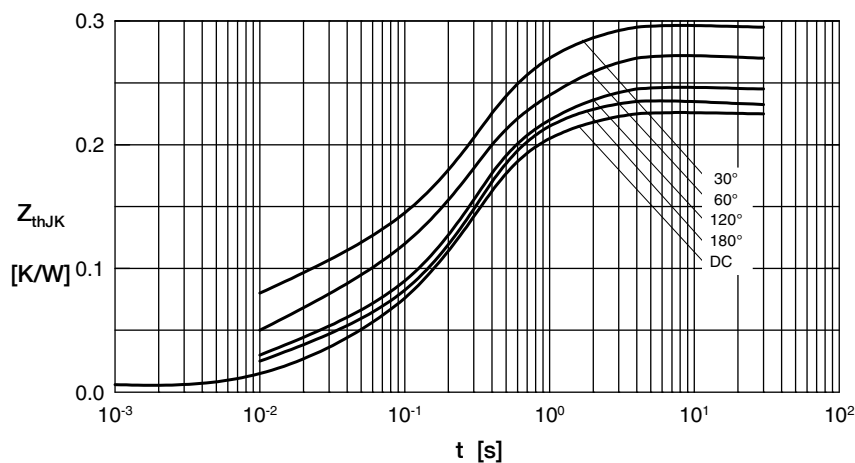

Fig. 10 Transient thermal impedance junction to heatsink (per thyristor/diode)

R_{thJK} for various conduction angles d:

d	R_{thJK} [K/W]
DC	0.225
180°	0.237
120°	0.246
60°	0.267
30°	0.297

Constants for Z_{thJK} calculation:

i	R_{thi} [K/W]	t_i [s]
1	0.0072	0.001
2	0.0188	0.080
3	0.1290	0.200
4	0.0700	1.000