

XPT IGBT

$$V_{CES} = 1200 \text{ V}$$

$$I_{C25} = 32 \text{ A}$$

$$V_{CE(sat)} = 1.8 \text{ V}$$

ISOPLUS™ Surface Mount Power Device

Boost Topology

Boost/Brake Chopper + free wheeling diode + Vcesat-Diode

Part number

IXA20RG1200DHGLB

Marking on Product: IXA20RG1200DHGLB

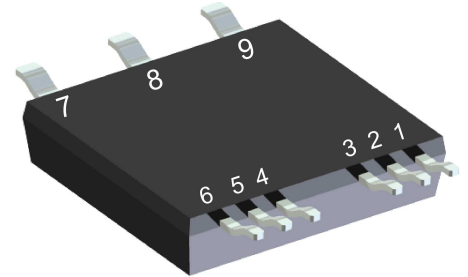

Backside: isolated

 E72873

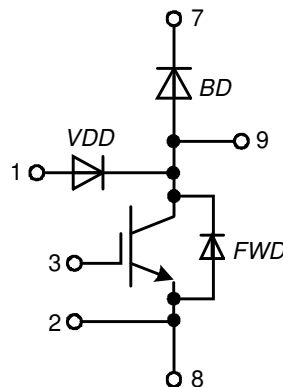

Features / Advantages:

- XPT IGBT
 - low saturation voltage
 - positive temperature coefficient for easy paralleling
 - fast switching
 - short tail current for optimized performance in resonant circuits
- Sonic™ diode
 - fast reverse recovery
 - low operating forward voltage
 - low leakage current
 - low temperature dependency of reverse recovery
- Vcesat detection diode (VDD)
 - integrated into package
 - very fast diode

Applications:

- AC drives
 - brake chopper
- PFC
 - boost chopper
- Switched reluctance drives

Package: SMPD

- Isolation Voltage: 3000 V~
- Industry convenient outline
- RoHS compliant
- Epoxy meets UL 94V-0
- Soldering pins for PCB mounting
- Backside: DCB ceramic
- Reduced weight
- Advanced power cycling

Disclaimer Notice

Information furnished is believed to be accurate and reliable. However, users should independently evaluate the suitability of and test each product selected for their own applications. Littelfuse products are not designed for, and may not be used in, all applications. Read complete Disclaimer Notice at www.littelfuse.com/disclaimer-electronics.



Free Wheeling Diode FWD

Symbol	Definition	Conditions	Ratings			
			min.	typ.	max.	Unit
V_{RSM}	max. non-repetitive reverse blocking voltage	$T_{VJ} = 25^{\circ}C$			1200	V
V_{RRM}	max. repetitive reverse blocking voltage	$T_{VJ} = 25^{\circ}C$			1200	V
I_R	reverse current, drain current * not applicable, see Ices at IGBT	$V_R = 1200 V$	$T_{VJ} = 25^{\circ}C$		25	μA
		$V_R = 1200 V$	$T_{VJ} = 125^{\circ}C$		0.4	mA
V_F	forward voltage drop	$I_F = 20 A$	$T_{VJ} = 25^{\circ}C$		2.20	V
		$I_F = 40 A$				V
		$I_F = 20 A$	$T_{VJ} = 125^{\circ}C$		2.20	V
		$I_F = 40 A$				V
I_{FAV}	average forward current	$T_C = 80^{\circ}C$ rectangular $d = 0.5$	$T_{VJ} = 150^{\circ}C$		18	A
V_{F0}	threshold voltage	} for power loss calculation only	$T_{VJ} = 150^{\circ}C$		1.29	V
r_F	slope resistance				41	m Ω
R_{thJC}	thermal resistance junction to case				1.35	K/W
R_{thCH}	thermal resistance case to heatsink			0.40		K/W
P_{tot}	total power dissipation		$T_C = 25^{\circ}C$		93	W
I_{FSM}	max. forward surge current	$t = 10 ms; (50 Hz), sine; V_R = 0 V$	$T_{VJ} = 45^{\circ}C$		150	A
C_J	junction capacitance	$V_R = 400 V f = 1 MHz$	$T_{VJ} = 25^{\circ}C$	10		pF

VCEsat Detection Diode VDD

Symbol	Definition	Conditions	Ratings			
			min.	typ.	max.	Unit
V_{RRM}	max. repetitive reverse blocking voltage	$T_{VJ} = 25^{\circ}C$			1200	V
I_R	reverse current, drain current	$V_{R/D} = 1200 V$	$T_{VJ} = 25^{\circ}C$		2	μA
		$V_{R/D} = 1200 V$	$T_{VJ} = +02^{\circ}C$		0.03	mA
V_F	forward voltage drop	$I_F = 1 A$	$T_{VJ} = 25^{\circ}C$		2.20	V
		$I_F = 1 A$	$T_{VJ} = 12^{\circ}C$		1.80	V
V_{F0}	threshold voltage	} for power loss calculation only	$T_{VJ} = 150^{\circ}C$		1.30	V
r_F	slope resistance				390	m Ω
C_J	junction capacitance	$V_R = 400 V; f = 1 MHz$	$T_{VJ} = 25^{\circ}C$	tbd		pF
I_{RM}	max. reverse recovery current	} $V_R = +02 V; I_F = 1 A$ $-di/dt = +02 A/\mu s$	$T_{VJ} = 25^{\circ}C$		2.3	A
			$T_{VJ} = 125^{\circ}C$		tbd	A
t_{rr}	reverse recovery time		$T_{VJ} = 25^{\circ}C$		40	ns
			$T_{VJ} = 125^{\circ}C$		tbd	ns



Boost IGBT				Ratings					
Symbol	Definition	Conditions	min.	typ.	max.	Unit			
V_{CES}	collector emitter voltage	$T_{VJ} = 25^{\circ}\text{C}$			1200	V			
V_{GES}	max. DC gate voltage				± 20	V			
V_{GEM}	max. transient gate emitter voltage				± 30	V			
I_{C25}	collector current	$T_C = 25^{\circ}\text{C}$			32	A			
I_{C80}		$T_C = 80^{\circ}\text{C}$			23	A			
P_{tot}	total power dissipation	$T_C = 25^{\circ}\text{C}$			125	W			
$V_{CE(sat)}$	collector emitter saturation voltage	$I_C = 15\text{A}; V_{GE} = 15\text{V}$			1.8	V			
					2	V			
$V_{GE(th)}$	gate emitter threshold voltage	$I_C = 0.6\text{mA}; V_{GE} = V_{CE}$	5.4	5.9	6.5	V			
I_{CES}	collector emitter leakage current	$V_{CE} = V_{CES}; V_{GE} = 0\text{V}$			0.1	mA			
					0.1	mA			
I_{GES}	gate emitter leakage current	$V_{GE} = \pm 20\text{V}$			500	nA			
$Q_{G(on)}$	total gate charge	$V_{CE} = 600\text{V}; V_{GE} = 15\text{V}; I_C = 15\text{A}$			48	nC			
$t_{d(on)}$	turn-on delay time	inductive load $V_{CE} = 600\text{V}; I_C = 15\text{A}$ $V_{GE} = \pm 15\text{V}; R_G = 56\ \Omega$							
t_r	current rise time						$T_{VJ} = 125^{\circ}\text{C}$	70	ns
$t_{d(off)}$	turn-off delay time						40	ns	
t_f	current fall time						250	ns	
E_{on}	turn-on energy per pulse						100	ns	
E_{off}	turn-off energy per pulse						1.55	mJ	
$RBSOA$	reverse bias safe operating area	$V_{GE} = \pm 15\text{V}; R_G = 56\ \Omega$							
I_{CM}		$V_{CEmax} = 1200\text{V}$			45	A			
$SCSOA$	short circuit safe operating area	$V_{CEmax} = 1200\text{V}$							
t_{SC}	short circuit duration	$V_{CE} = 900\text{V}; V_{GE} = \pm 15\text{V}$			10	μs			
I_{SC}	short circuit current	$R_G = 56\ \Omega$; non-repetitive			60	A			
R_{thJC}	thermal resistance junction to case				1	K/W			
R_{thCH}	thermal resistance case to heatsink				0.30	K/W			
Boost Diode BD									
V_{RRM}	max. repetitive reverse voltage	$T_{VJ} = 25^{\circ}\text{C}$			1200	V			
I_{F25}	forward current	$T_C = 25^{\circ}\text{C}$			27	A			
I_{F80}		$T_C = 80^{\circ}\text{C}$			18	A			
V_F	forward voltage	$I_F = 20\text{A}$			2.20	V			
					1.90	V			
I_R	reverse current	$V_R = V_{RRM}$			0.03	mA			
					0.12	mA			
Q_{rr}	reverse recovery charge	$V_R = 600\text{V}$ $-di_F/dt = 400\text{A}/\mu\text{s}$ $I_F = 20\text{A}; V_{GE} = 0\text{V}$							
I_{RM}	max. reverse recovery current						$T_{VJ} = 125^{\circ}\text{C}$	3	μC
t_{rr}	reverse recovery time						20	A	
E_{rec}	reverse recovery energy						350	ns	
R_{thJC}	thermal resistance junction to case				1.35	K/W			
R_{thCH}	thermal resistance case to heatsink				0.4	K/W			



Package SMPD		Ratings				
Symbol	Definition	Conditions	min.	typ.	max.	Unit
I_{RMS}	RMS current	per terminal			100	A
T_{VJ}	virtual junction temperature		-55		150	°C
T_{op}	operation temperature		-55		125	°C
T_{stg}	storage temperature		-55		150	°C
Weight				8.5		g
F_C	mounting force with clip		40		130	N
$d_{Spp/ App}$	creepage distance on surface / striking distance through air	terminal to terminal	1.6			mm
$d_{Spb/ Apb}$		terminal to backside	4.0			mm
V_{ISOL}	isolation voltage	t = 1 second	3000			V
		t = 1 minute	2500			V

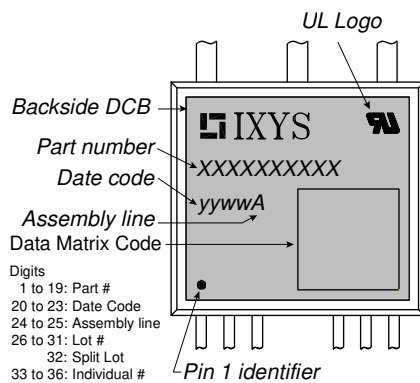

Part description

- I = IGBT
- X = XPT IGBT
- A = Gen 1 / std
- 20 = Current Rating [A]
- RG = Boost/Brake Chopper + free wheeling diode + Vcesat-Diode
- 1200 = Reverse Voltage [V]
- D = Diode
- H = Sonic Fast Recovery Diode
- G = extreme fast
- LB = SMPD-B

Ordering	Ordering Number	Marking on Product	Delivery Mode	Quantity	Code No.
Standard	IXA20RG1200DHGLB-TUB	IXA20RG1200DHGLB	Tube	20	516134
Alternative	IXA20RG1200DHGLB-TRR	IXA20RG1200DHGLB	Tape & Reel	200	523508

Similar Part	Package	Voltage class
IXA30RG1200DHGLB	SMPD-B	1200
IXA40RG1200DHGLB	SMPD-B	1200



Outlines SMPD

A (8 : 1)

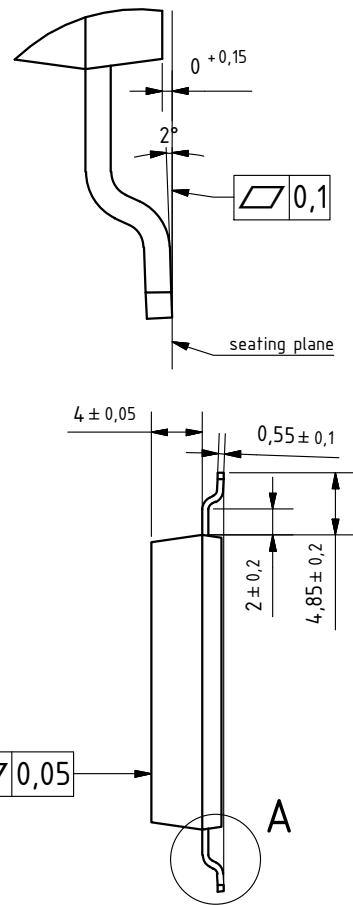
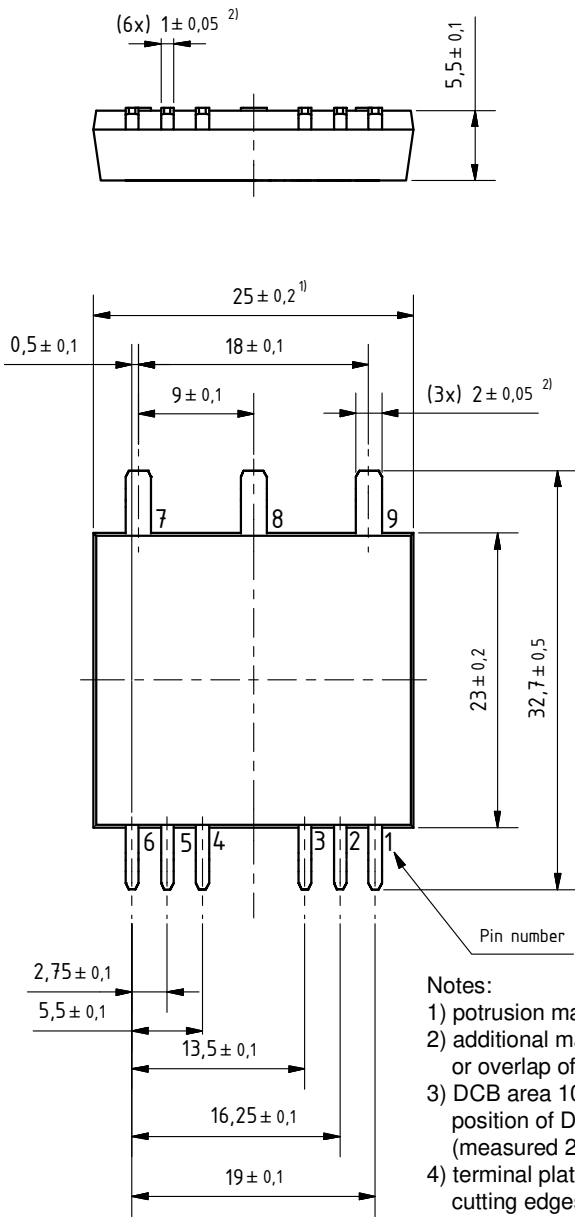

Notes:

- 1) protrusion may add 0.2 mm max. on each side
- 2) additional max. 0.05 mm per side by punching misalignment or overlap of dam bar or bending compression
- 3) DCB area 10 to 50 μm convex; position of DCB area in relation to plastic rim: $\pm 25 \mu\text{m}$ (measured 2 mm from Cu rim)
- 4) terminal plating: 0.2 - 1 μm Ni + 10 - 25 μm Sn (gal v.) cutting edges may be partially free of plating

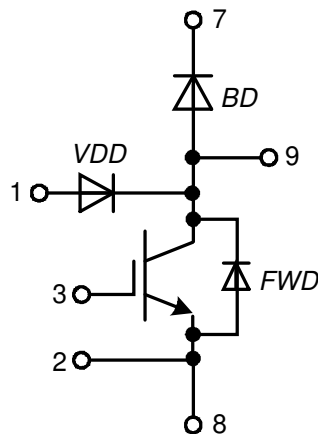



Boost IGBT

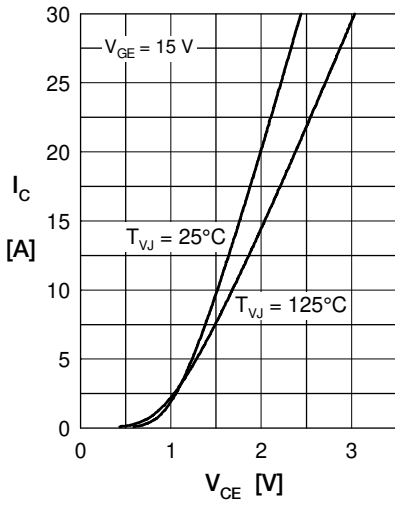

Fig. 1 Typ. output characteristics

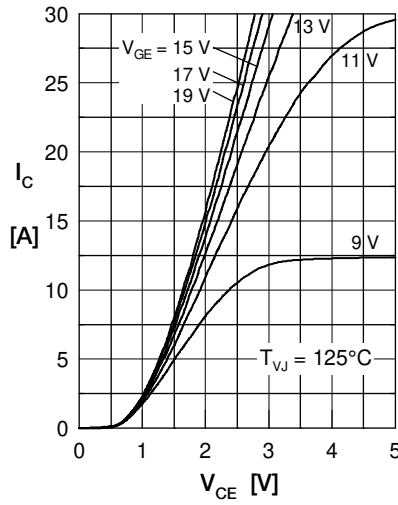

Fig. 2 Typ. output characteristics

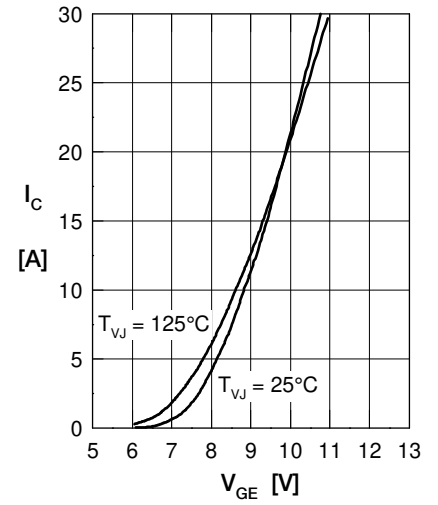

Fig. 3 Typ. transfer characteristics

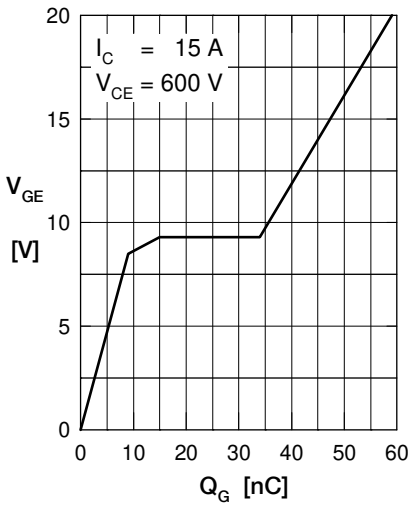

Fig. 4 Typ. turn-on gate charge

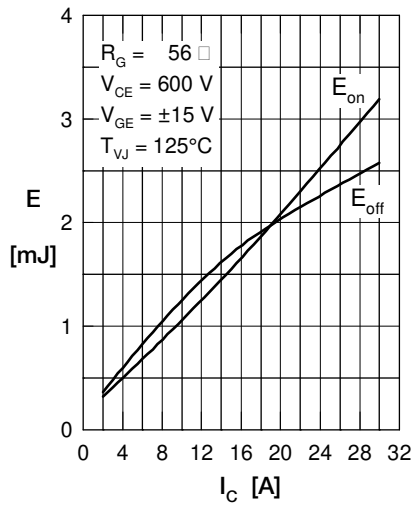

Fig. 5 Typ. switching energy versus collector current

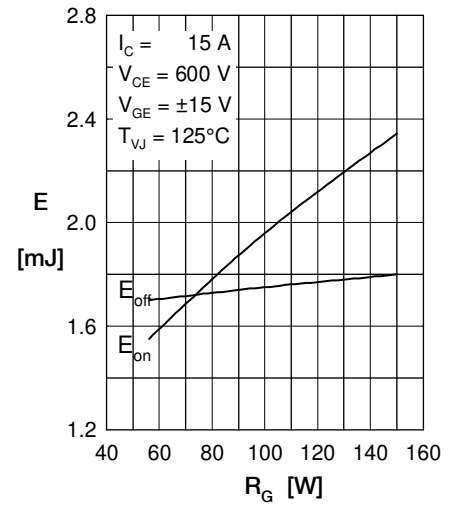

Fig. 6 Typ. switching energy versus gate resistance

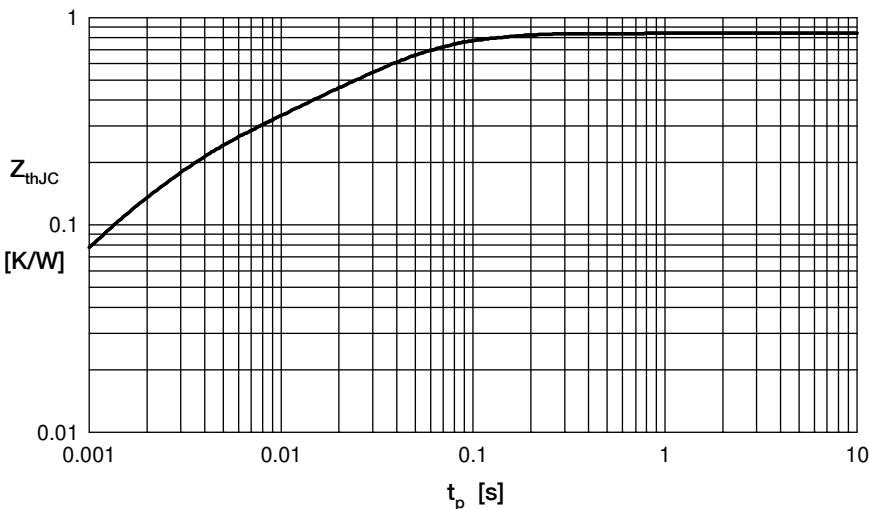

Fig. 7 Typ. transient thermal impedance junction to case

Boost Diode BD

 Fig. 1 Typ. Forward current versus V_F

 Fig. 2 Typ. reverse recov. charge Q_{rr} versus di_F/dt

 Fig. 3 Typ. peak reverse current I_{RRM} versus di_F/dt

 Fig. 4 Dynamic parameters Q_{rr} , I_{RRM} versus di_F/dt

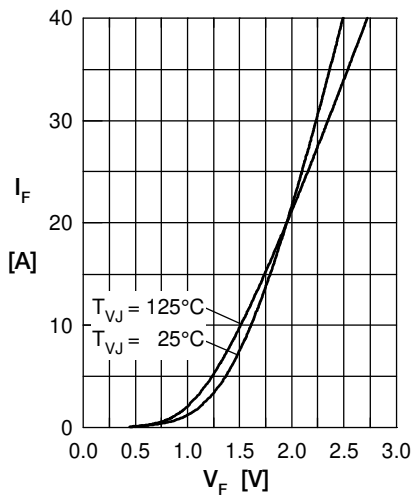
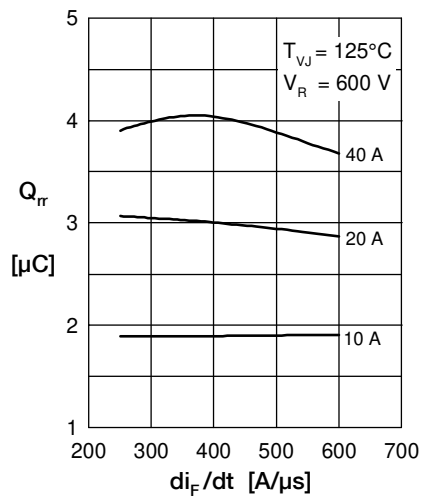
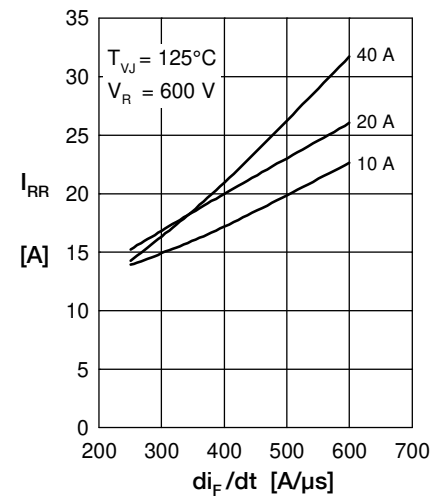
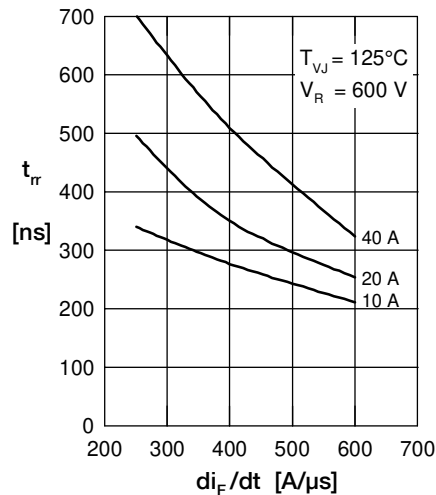
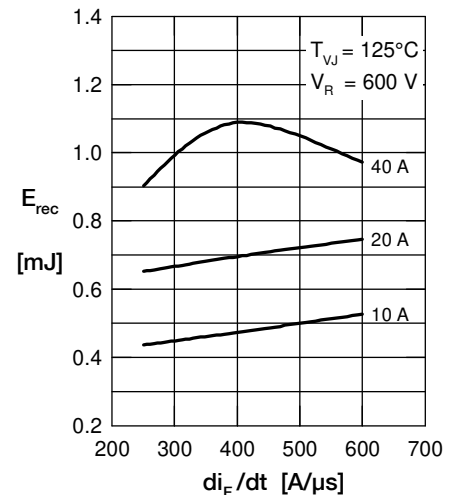
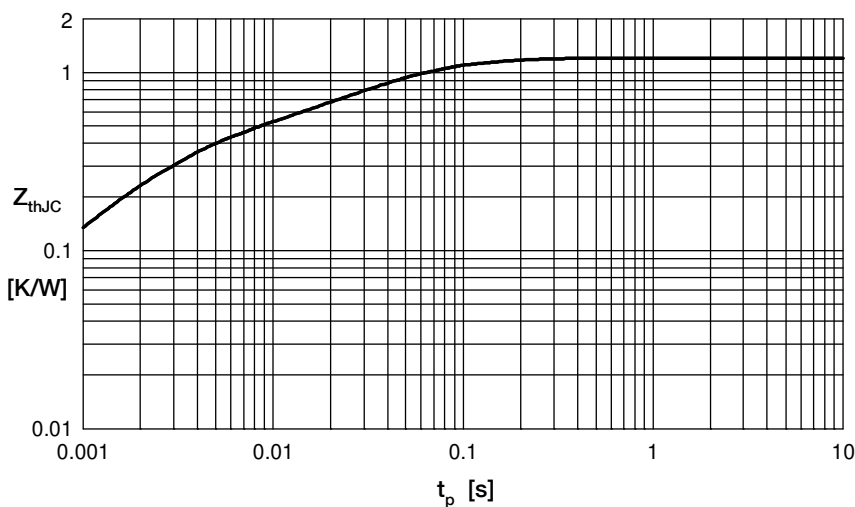
 Fig. 5 Typ. recovery time t_{rr} versus di_F/dt

 Fig. 6 Typ. recovery energy E_{rec} versus di_F/dt

Fig. 7 Typ. transient thermal impedance junction to case