

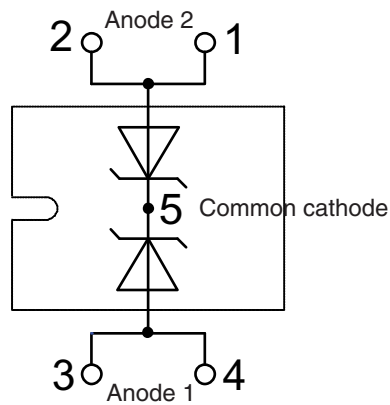
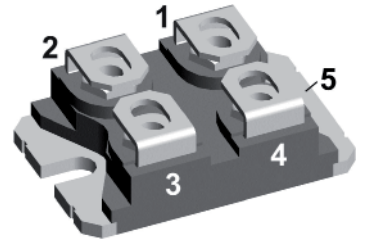
# Power Schottky Rectifier

Non isolated

$I_{FAVM} = 2x160 \text{ A}$   
 $V_{RRM} = 45 \text{ V}$   
 $V_F = 0.72 \text{ V}$

Part number

**DSS 2x160-0045A**



**Features / Advantages:**

- Very low  $V_F$
- Extremely low switching losses
- Low  $I_{RM}$ -values
- High reliability circuit operation
- Low voltage peaks for reduced protection circuits
- Low noise switching
- Low losses

**Applications:**

- Rectifiers in switch mode power supplies (SMPS)
- Free wheeling diode in low voltage converters

**Package:** SOT-227UI (minibloc)

- Industry standard outline
- RoHS compliant
- Epoxy meets UL 94V-0
- Base plate: Copper (non isolated)
- Advanced power cycling

**Disclaimer Notice**

Information furnished is believed to be accurate and reliable. However, users should independently evaluate the suitability of and test each product selected for their own applications. Littelfuse products are not designed for, and may not be used in, all applications. Read complete Disclaimer Notice at [www.littelfuse.com/disclaimer-electronics](http://www.littelfuse.com/disclaimer-electronics).

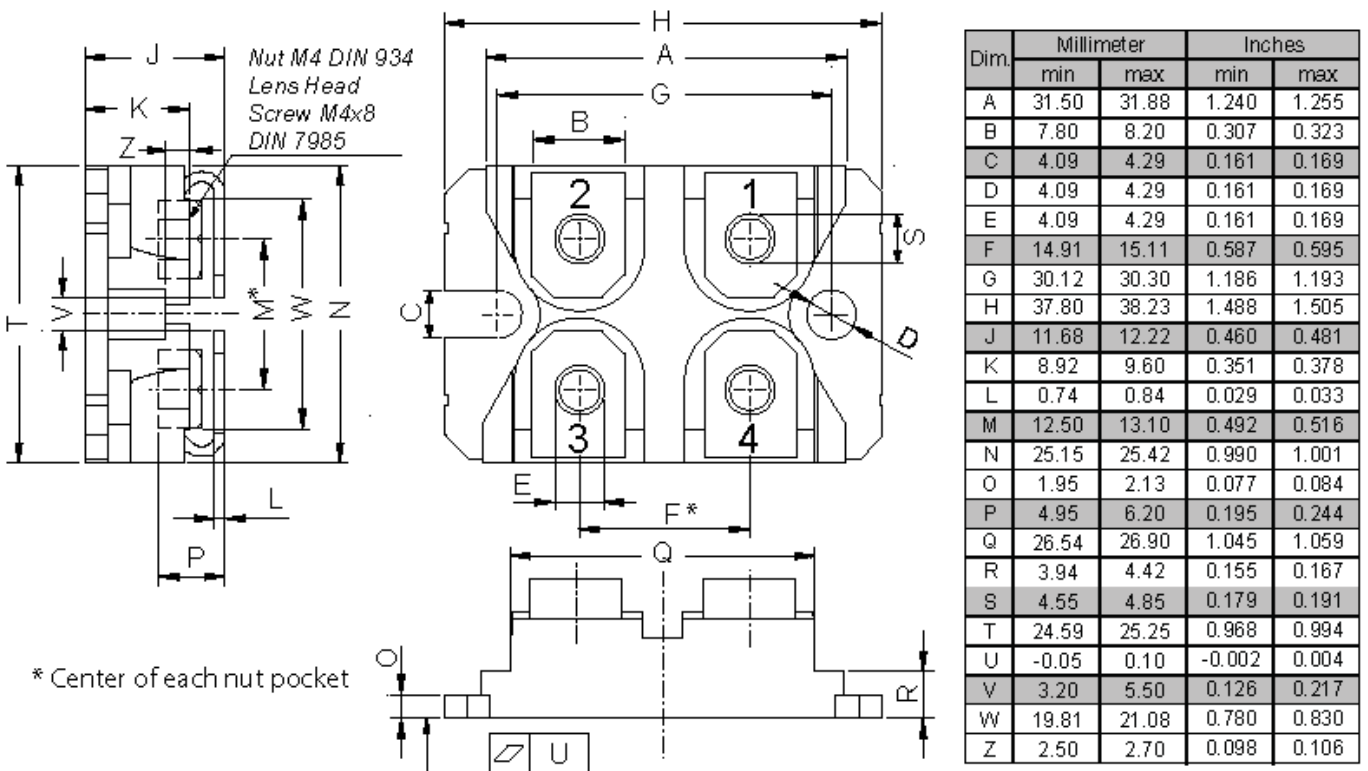
Symbol	Conditions	Maximum Ratings	
$I_{FRMS}$		200	A
$I_{FAVM}$	$T_C = 100^\circ\text{C}$ ; rectangular, $d = 0.5$	160	A
$I_{FAVM}$	$T_C = 100^\circ\text{C}$ ; rectangular, $d = 0.5$ ; per device	320	A
$I_{FSM}$	$T_{VJ} = 45^\circ\text{C}$ ; $t = 10$ ms (50 Hz), sine	1600	A
$E_{AS}$	$I_{AS} = 28$ A; $L = 180$ $\mu\text{H}$ ; $T_{VJ} = 25^\circ\text{C}$ ; non repetitive	112	mJ
$I_{AR}$	$V_A = 1.5 \cdot V_{RRM}$ typ.; $f = 10$ kHz; repetitive	2.8	A
$(dv/dt)_{cr}$		1000	V/ $\mu\text{s}$
$P_{tot}$	$T_C = 25^\circ\text{C}$	410	W

Symbol	Conditions	Characteristic Values		
		typ.	max.	
$I_R$ ①	$V_R = V_{RRM}$ $T_{VJ} = 25^\circ\text{C}$		4	mA
	$V_R = V_{RRM}$ $T_{VJ} = 125^\circ\text{C}$		40	mA
$V_F$	$I_F = 160$ A $T_{VJ} = 125^\circ\text{C}$		0.72	V
	$T_{VJ} = 25^\circ\text{C}$		0.80	V
	$I_F = 320$ A $T_{VJ} = 125^\circ\text{C}$		0.98	V
$R_{thJC}$			0.3	K/W
$R_{thCH}$		0.15		K/W

① Pulse Width = 5 ms, Duty Cycle < 2.0 %

Data according to IEC 60747 and per diode unless otherwise specified

### Outlines SOT-227B (minibloc)

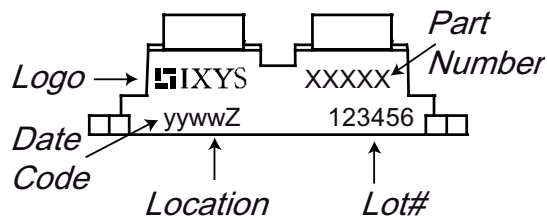


IXYS reserves the right to change limits, test conditions and dimensions.

20220623a

Package SOT-227B (minibloc)				Ratings			
Symbol	Definitions	Conditions	min.	typ.	max.		
$I_{RMS}$	RMS current	per terminal			150	A	
$T_{VJ}$	virtual junction temperature		-40		150	°C	
$T_{op}$	operation temperature		-40		125	°C	
$T_{stg}$	storage temperature		-40		150	°C	
<b>Weight</b>				30		g	
$M_D$	mounting torque		1.1		1.5	Nm	
$M_T$	terminal torque		1.1		1.5	Nm	
$d_{Spp/APP}$	creepage distance on surface   striking distance through air	terminal to terminal	10.5	0.8		Nm	
$d_{Spb/APb}$		terminal to backside	8.6	20		N	

### Product Marking



Ordering	Part Number	Marking on Product	Delivering Mode	Base Qty	Ordering Code
Standard	DSS2x160-0045A	DSS2x160-0045A	Tube	10	DSS2x160-0045A

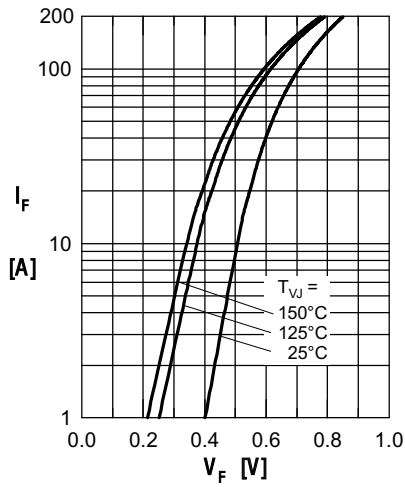
**Curves**


Fig. 1 Max. forward voltage drop characteristics

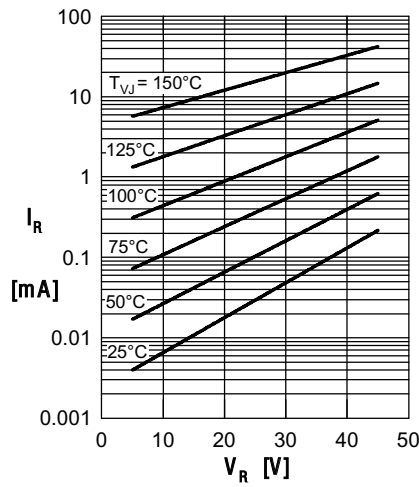
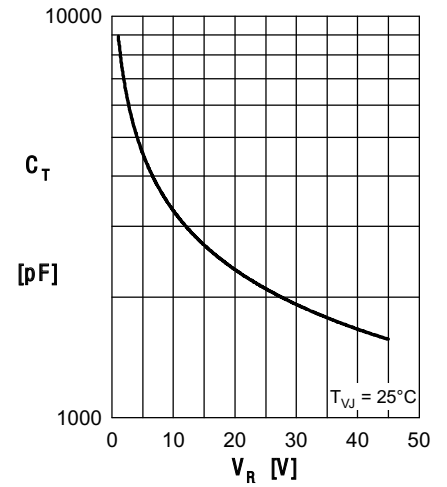
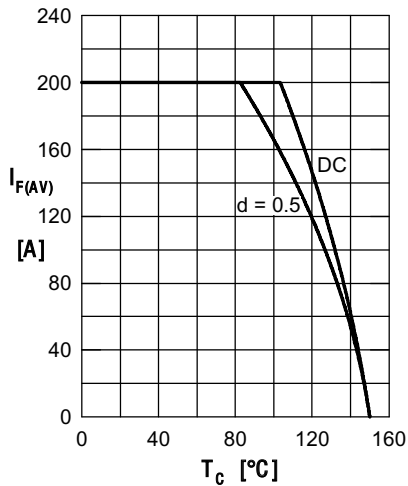
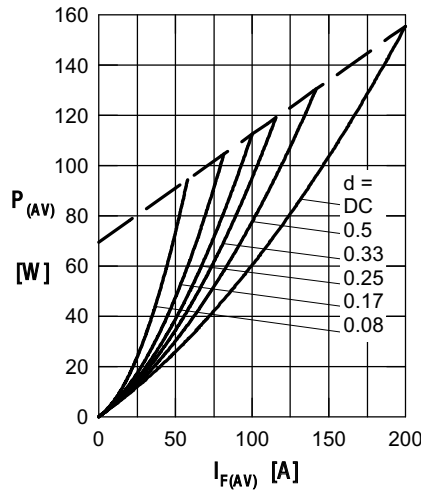

 Fig. 2 Typ. reverse current  $I_R$  vs. reverse voltage  $V_R$ 

 Fig. 3 Typ. junction capacitance  $C_T$  vs. reverse voltage  $V_R$ 

 Fig. 4 Average forward current  $I_{F(AV)}$  vs. case temp.  $T_C$ 


Fig. 5 Forward power loss characteristics

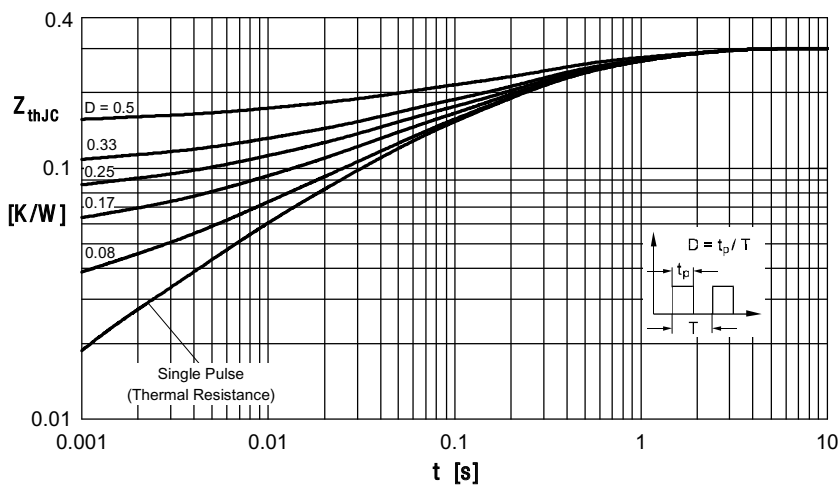


Fig. 6 Transient thermal impedance junction to case at various duty cycles

Note: All curves are per diode