

# Standard Rectifier

$$V_{RRM} = 2 \times 1600 \text{ V}$$

$$I_{FAV} = 45 \text{ A}$$

$$V_F = 1.23 \text{ V}$$

Phase leg

Part number

**DSP45-16A**

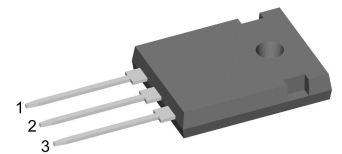

Backside: anode/cathode

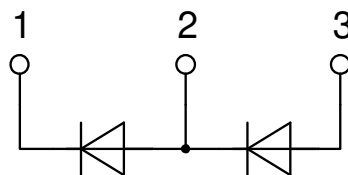

### Features / Advantages:

- Planar passivated chips
- Very low leakage current
- Very low forward voltage drop
- Improved thermal behaviour

### Applications:

- Diode for main rectification
- For single and three phase bridge configurations

### Package: TO-247

- Industry standard outline
- RoHS compliant
- Epoxy meets UL 94V-0

### Disclaimer Notice

Information furnished is believed to be accurate and reliable. However, users should independently evaluate the suitability of and test each product selected for their own applications. Littelfuse products are not designed for, and may not be used in, all applications. Read complete Disclaimer Notice at [www.littelfuse.com/disclaimer-electronics](http://www.littelfuse.com/disclaimer-electronics).

Rectifier				Ratings			
Symbol	Definition	Conditions	min.	typ.	max.	Unit	
$V_{RSM}$	max. non-repetitive reverse blocking voltage	$T_{VJ} = 25^{\circ}C$			1700	V	
$V_{RRM}$	max. repetitive reverse blocking voltage	$T_{VJ} = 25^{\circ}C$			1600	V	
$I_R$	reverse current	$V_R = 1600\text{ V}$	$T_{VJ} = 25^{\circ}C$		40	$\mu A$	
		$V_R = 1600\text{ V}$	$T_{VJ} = 150^{\circ}C$		1.5	mA	
$V_F$	forward voltage drop	$I_F = 45\text{ A}$	$T_{VJ} = 25^{\circ}C$		1.26	V	
		$I_F = 90\text{ A}$			1.57	V	
		$I_F = 45\text{ A}$	$T_{VJ} = 150^{\circ}C$		1.23	V	
		$I_F = 90\text{ A}$			1.66	V	
$I_{FAV}$	average forward current	$T_C = 130^{\circ}C$ 180° sine	$T_{VJ} = 175^{\circ}C$		45	A	
$V_{FO}$	threshold voltage	} for power loss calculation only	$T_{VJ} = 175^{\circ}C$		0.81	V	
$r_F$	slope resistance				9.1	m $\Omega$	
$R_{thJC}$	thermal resistance junction to case				0.55	K/W	
$R_{thCH}$	thermal resistance case to heatsink			0.3		K/W	
$P_{tot}$	total power dissipation		$T_C = 25^{\circ}C$		270	W	
$I_{FSM}$	max. forward surge current	$t = 10\text{ ms}; (50\text{ Hz}), \text{ sine}$	$T_{VJ} = 45^{\circ}C$		480	A	
		$t = 8,3\text{ ms}; (60\text{ Hz}), \text{ sine}$	$V_R = 0\text{ V}$		520	A	
		$t = 10\text{ ms}; (50\text{ Hz}), \text{ sine}$	$T_{VJ} = 150^{\circ}C$		410	A	
		$t = 8,3\text{ ms}; (60\text{ Hz}), \text{ sine}$	$V_R = 0\text{ V}$		440	A	
$I^2t$	value for fusing	$t = 10\text{ ms}; (50\text{ Hz}), \text{ sine}$	$T_{VJ} = 45^{\circ}C$		1.15	kA <sup>2</sup> s	
		$t = 8,3\text{ ms}; (60\text{ Hz}), \text{ sine}$	$V_R = 0\text{ V}$		1.13	kA <sup>2</sup> s	
		$t = 10\text{ ms}; (50\text{ Hz}), \text{ sine}$	$T_{VJ} = 150^{\circ}C$		840	A <sup>2</sup> s	
		$t = 8,3\text{ ms}; (60\text{ Hz}), \text{ sine}$	$V_R = 0\text{ V}$		805	A <sup>2</sup> s	
$C_J$	junction capacitance	$V_R = 400\text{ V}; f = 1\text{ MHz}$	$T_{VJ} = 25^{\circ}C$		18	pF	



Package TO-247			Ratings			
Symbol	Definition	Conditions	min.	typ.	max.	Unit
$I_{RMS}$	RMS current	per terminal			70	A
$T_{VJ}$	virtual junction temperature		-40		175	°C
$T_{op}$	operation temperature		-40		150	°C
$T_{stg}$	storage temperature		-40		150	°C
<b>Weight</b>				6		g
$M_D$	mounting torque		0.8		1.2	Nm
$F_C$	mounting force with clip		20		120	N

**Product Marking**

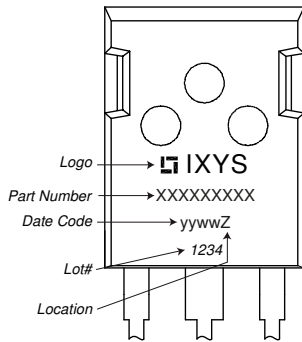

Ordering	Ordering Number	Marking on Product	Delivery Mode	Quantity	Code No.
Standard	DSP45-16A	DSP45-16A	Tube	30	480665

Similar Part	Package	Voltage class
DSP45-16AZ	TO-268AA (D3Pak) (2HV)	1600
DSP45-16AR	ISOPLUS247 (3)	1600
DSP45-12A	TO-247AD (3)	1200
DSP45-12AZ	TO-268AA (D3Pak) (2HV)	1200

DSP45-18A	TO-247AD (3)	1800
-----------	--------------	------

**Equivalent Circuits for Simulation**

*\* on die level*

$T_{VJ} = 175^{\circ}\text{C}$

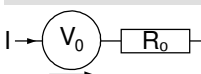

**Rectifier**

$V_{0\ max}$	threshold voltage	0.81	V
$R_{0\ max}$	slope resistance *	6.5	mΩ



**Outlines TO-247**

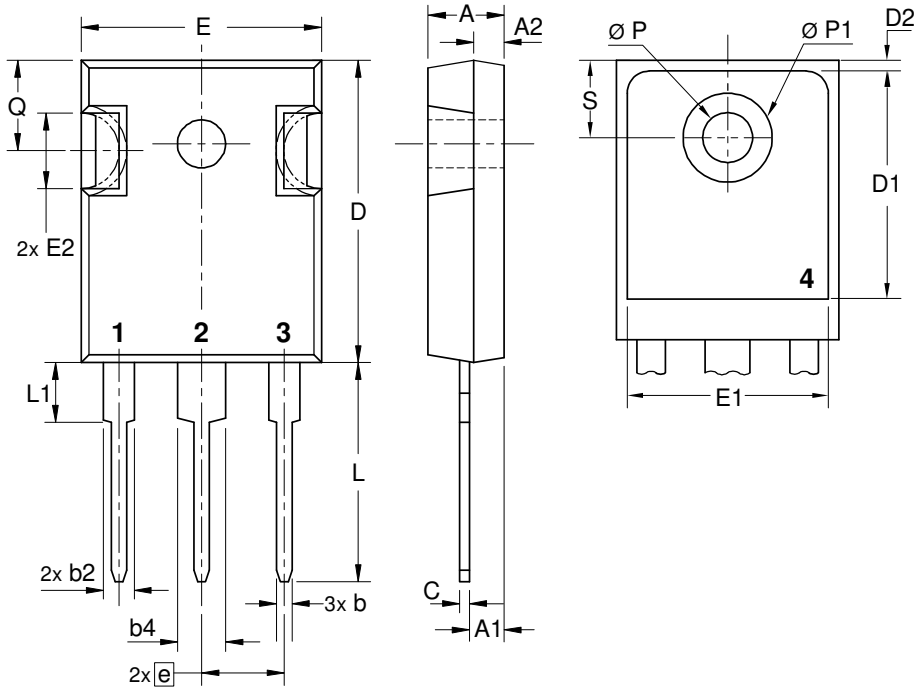

Sym.	Inches		Millimeter	
	min.	max.	min.	max.
A	0.185	0.209	4.70	5.30
A1	0.087	0.102	2.21	2.59
A2	0.059	0.098	1.50	2.49
D	0.819	0.845	20.79	21.45
E	0.610	0.640	15.48	16.24
E2	0.170	0.216	4.31	5.48
e	0.215 BSC		5.46 BSC	
L	0.780	0.800	19.80	20.30
L1	-	0.177	-	4.49
Ø P	0.140	0.144	3.55	3.65
Q	0.212		5.38	
S	0.242 BSC		6.14 BSC	
b	0.039	0.055	0.99	1.40
b2	0.065	0.094	1.65	2.39
b4	0.102	0.135	2.59	3.43
c	0.015	0.035	0.38	0.89
D1	0.515	-	13.07	-
D2	0.020	0.053	0.51	1.35
E1	0.530	-	13.45	-
Ø P1	-	0.29	-	7.39

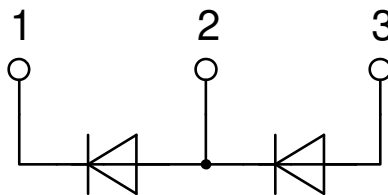



**Rectifier**

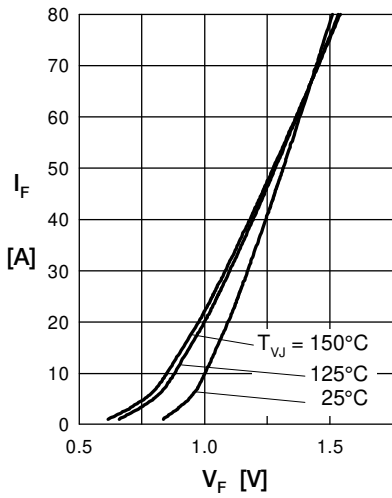

Fig. 1 Forward current versus voltage drop per diode

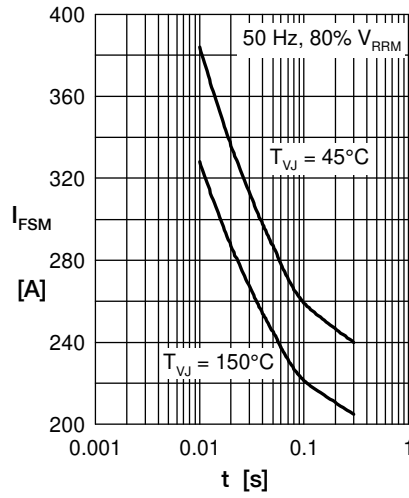

Fig. 2 Surge overload current

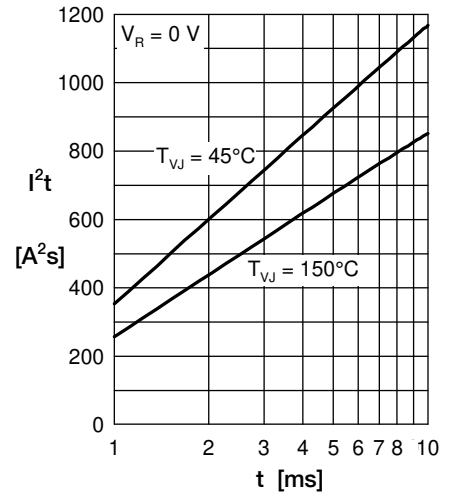

Fig. 3  $I^2t$  versus time per diode

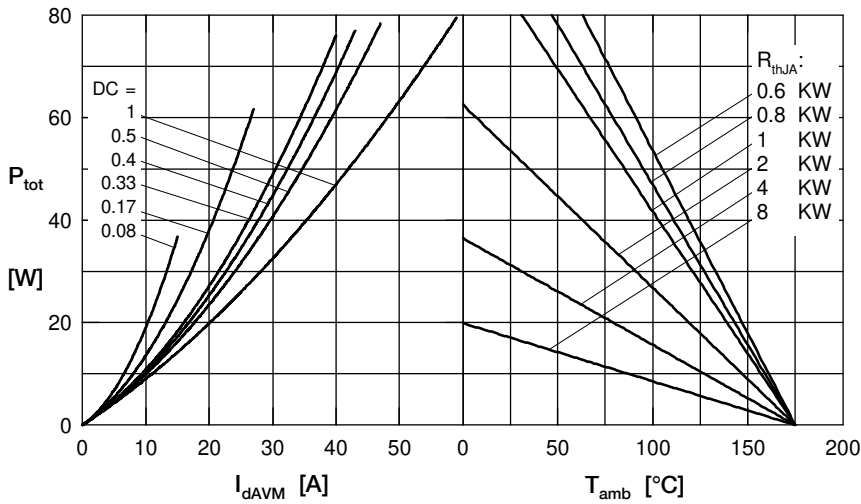

Fig. 4 Power dissipation vs. direct output current & ambient temperature

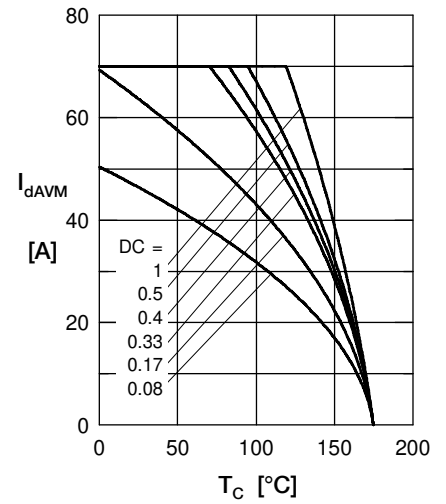

Fig. 5 Max. forward current vs. case temperature

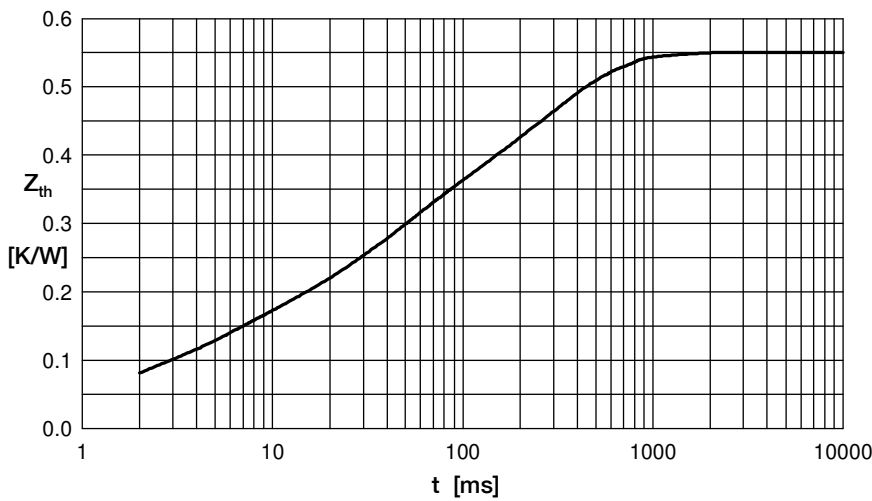

Fig. 6 Transient thermal impedance junction to case

i	$R_i$	$t_i$
1	0.033	0.0006
2	0.095	0.0039
3	0.164	0.033
4	0.258	0.272