



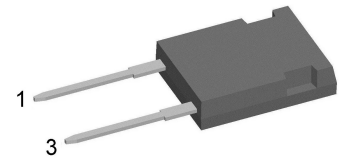
Standard Rectifier

$V_{RRM} = 1600\text{ V}$
 $I_{FAV} = 45\text{ A}$
 $V_F = 1.23\text{ V}$

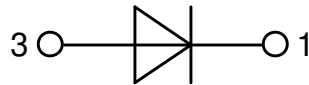
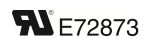
Single Diode

Part number

DSI45-16AR



Backside: isolated



Features / Advantages:

- Planar passivated chips
- Very low leakage current
- Very low forward voltage drop
- Improved thermal behaviour

Applications:

- Diode for main rectification
- For single and three phase bridge configurations

Package: ISOPLUS247

- Isolation Voltage: 3600 V~
- Industry standard outline
- RoHS compliant
- Epoxy meets UL 94V-0
- Soldering pins for PCB mounting
- Backside: DCB ceramic
- Reduced weight
- Advanced power cycling

Disclaimer Notice

Information furnished is believed to be accurate and reliable. However, users should independently evaluate the suitability of and test each product selected for their own applications. Littelfuse products are not designed for, and may not be used in, all applications. Read complete Disclaimer Notice at www.littelfuse.com/disclaimer-electronics.

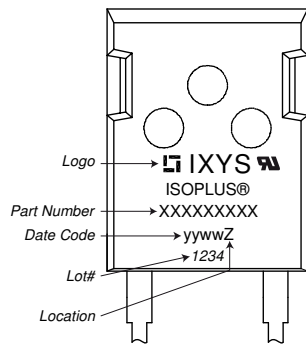


Rectifier				Ratings			
Symbol	Definition	Conditions	min.	typ.	max.	Unit	
V_{RSM}	max. non-repetitive reverse blocking voltage				1700	V	
V_{RRM}	max. repetitive reverse blocking voltage				1600	V	
I_R	reverse current	$V_R = 1600$ V			40	μ A	
		$V_R = 1600$ V			1.5	mA	
V_F	forward voltage drop	$I_F = 45$ A			1.26	V	
		$I_F = 90$ A			1.57	V	
		$I_F = 45$ A			1.23	V	
		$I_F = 90$ A			1.66	V	
I_{FAV}	average forward current	$T_C = 100^\circ$ C			45	A	
		sine 180°					
V_{F0}	threshold voltage	} for power loss calculation only			0.81	V	
r_F	slope resistance				9.1	m Ω	
R_{thJC}	thermal resistance junction to case				0.9	K/W	
R_{thCH}	thermal resistance case to heatsink			0.3		K/W	
P_{tot}	total power dissipation				165	W	
I_{FSM}	max. forward surge current	t = 10 ms; (50 Hz), sine			480	A	
		t = 8,3 ms; (60 Hz), sine			520	A	
		t = 10 ms; (50 Hz), sine			410	A	
		t = 8,3 ms; (60 Hz), sine			440	A	
I^2t	value for fusing	t = 10 ms; (50 Hz), sine			1.15	kA ² s	
		t = 8,3 ms; (60 Hz), sine			1.13	kA ² s	
		t = 10 ms; (50 Hz), sine			840	A ² s	
		t = 8,3 ms; (60 Hz), sine			805	A ² s	
C_J	junction capacitance	$V_R = 400$ V; f = 1 MHz			18	pF	



Package ISOPLUS247		Ratings				
Symbol	Definition	Conditions	min.	typ.	max.	Unit
I_{RMS}	RMS current	per terminal			70	A
T_{VJ}	virtual junction temperature		-40		175	°C
T_{op}	operation temperature		-40		150	°C
T_{stg}	storage temperature		-40		150	°C
Weight				6		g
F_C	mounting force with clip		20		120	N
$d_{Spp/ App}$	creepage distance on surface / striking distance through air	terminal to terminal	5.4			mm
$d_{Spb/ Apb}$		terminal to backside	4.1			mm
V_{ISOL}	isolation voltage	t = 1 second	3600			V
		t = 1 minute	3000			V

Product Marking



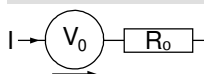
Ordering	Ordering Number	Marking on Product	Delivery Mode	Quantity	Code No.
Standard	DSI45-16AR	DSI45-16AR	Tube	30	480428

Similar Part	Package	Voltage class
DSI45-16A	TO-247AD (2)	1600
DSI45-12A	TO-247AD (2)	1200
DSI45-08A	TO-247AD (2)	800

Equivalent Circuits for Simulation

* on die level

$T_{VJ} = 175^{\circ}C$

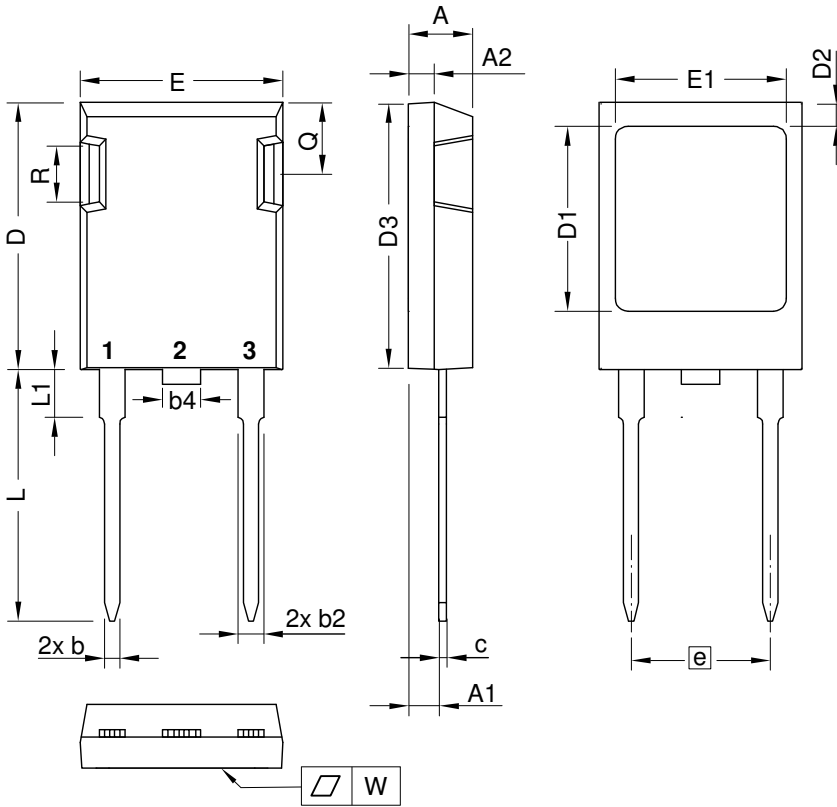


Rectifier

$V_{0 \max}$	threshold voltage	0.81	V
$R_{0 \max}$	slope resistance *	6.5	mΩ



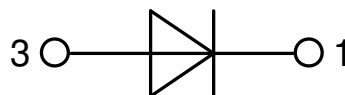
Outlines ISOPLUS247



Dim.	Millimeter		Inches	
	min	max	min	max
A	4.83	5.21	0.190	0.205
A1	2.29	2.54	0.090	0.100
A2	1.91	2.16	0.075	0.085
b	1.14	1.40	0.045	0.055
b2	1.91	2.20	0.075	0.087
b4	2.92	3.24	0.115	0.128
c	0.61	0.83	0.024	0.033
D	20.80	21.34	0.819	0.840
D1	15.75	16.26	0.620	0.640
D2	1.65	2.15	0.065	0.085
D3	20.30	20.70	0.799	0.815
E	15.75	16.13	0.620	0.635
E1	13.21	13.72	0.520	0.540
e	10.90 BSC		0.429 BSC	
L	19.81	20.60	0.780	0.811
L1	3.81	4.38	0.150	0.172
Q	5.59	6.20	0.220	0.244
R	4.25	5.50	0.167	0.217
W	-	0.10	-	0.004

Die konvexe Form des Substrates ist typ. < 0.04 mm über der Kunststoffoberfläche der Bauteilunterseite
The convex bow of substrate is typ. < 0.04 mm over plastic surface level of device bottom side

Die Gehäuseabmessungen entsprechen dem Typ TO-247 AD gemäß JEDEC außer Schraubloch und L_{max} .
This drawing will meet all dimensions requirement of JEDEC outline TO-247 AD except screw hole and except L_{max} .



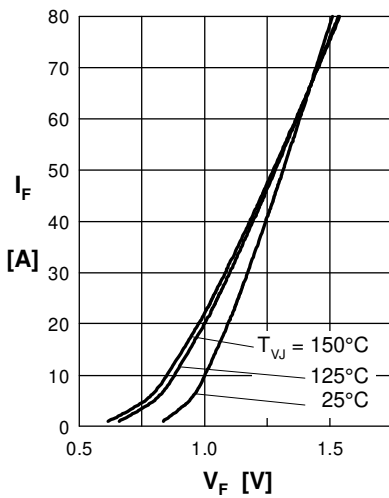
Rectifier


Fig. 1 Forward current versus voltage drop per diode

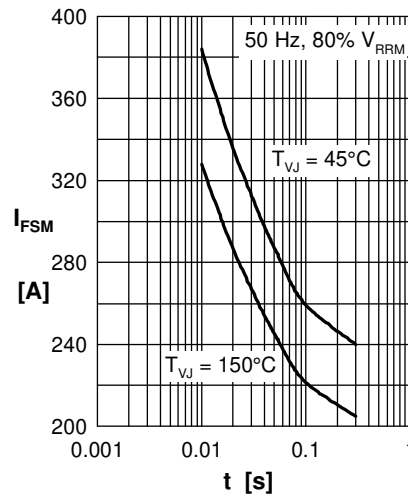


Fig. 2 Surge overload current

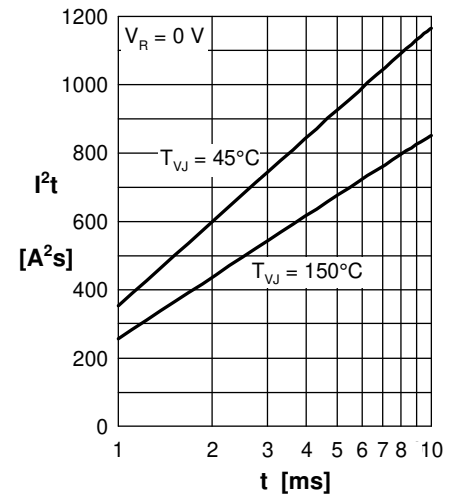
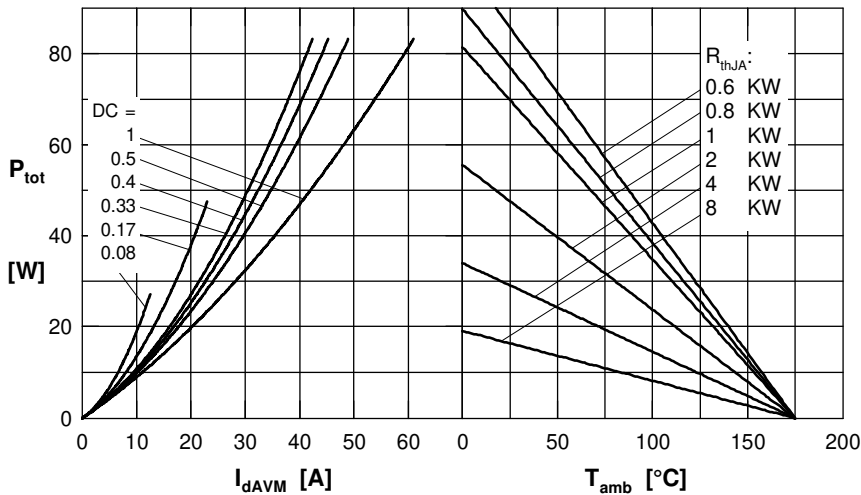

 Fig. 3 I^2t versus time per diode


Fig. 4 Power dissipation vs. direct output current & ambient temperature

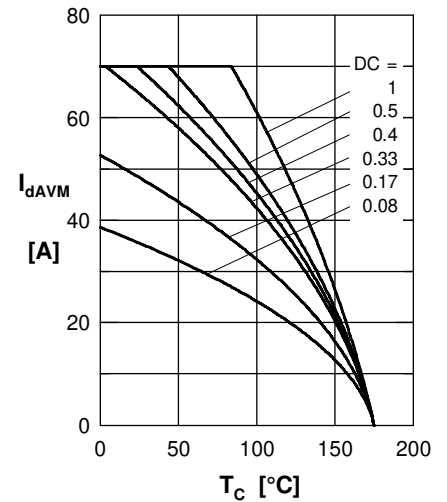


Fig. 5 Max. forward current vs. case temperature

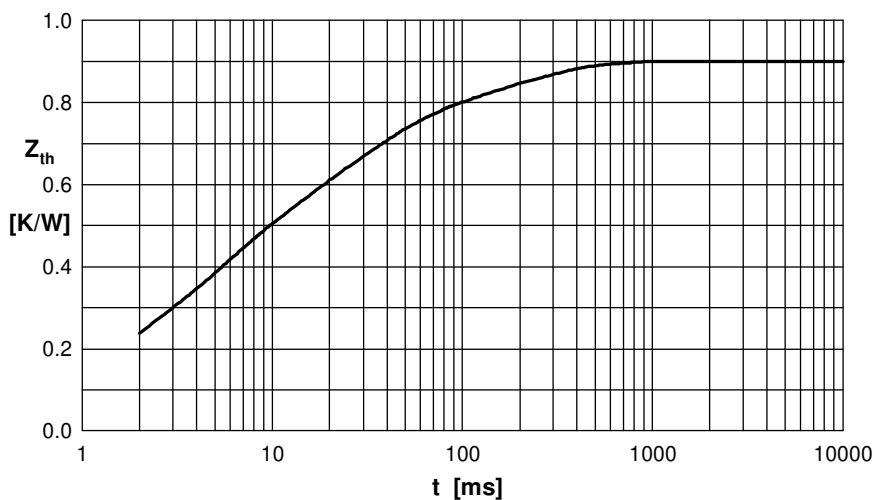


Fig. 6 Transient thermal impedance junction to case

i	R _i	t _i
1	0.0607	0.0004
2	0.123	0.00256
3	0.2305	0.045
4	0.323	0.0242
5	0.1628	0.18