



HiPerFRED

$V_{RRM} = 1200\text{ V}$
 $I_{FAV} = 12\text{ A}$
 $t_{rr} = 35\text{ ns}$

High Performance Fast Recovery Diode
 Low Loss and Soft Recovery
 Single Diode

Part number

DSEP12-12BZ

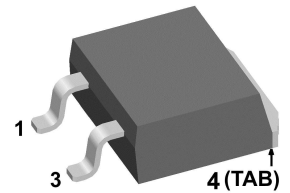

Backside: cathode

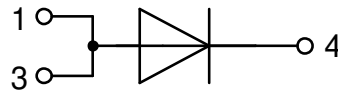

Features / Advantages:

- Planar passivated chips
- Very low leakage current
- Very short recovery time
- Improved thermal behaviour
- Very low I_{rm} -values
- Very soft recovery behaviour
- Avalanche voltage rated for reliable operation
- Soft reverse recovery for low EMI/RFI
- Low I_{rm} reduces:
 - Power dissipation within the diode
 - Turn-on loss in the commutating switch

Applications:

- Antiparallel diode for high frequency switching devices
- Antisaturation diode
- Snubber diode
- Free wheeling diode
- Rectifiers in switch mode power supplies (SMPS)
- Uninterruptible power supplies (UPS)

Package: TO-263 (D2Pak-HV)

- Industry standard outline
- RoHS compliant
- Epoxy meets UL 94V-0

Disclaimer Notice

Information furnished is believed to be accurate and reliable. However, users should independently evaluate the suitability of and test each product selected for their own applications. Littelfuse products are not designed for, and may not be used in, all applications. Read complete Disclaimer Notice at www.littelfuse.com/disclaimer-electronics.



Fast Diode				Ratings			
Symbol	Definition	Conditions	min.	typ.	max.	Unit	
V_{RSM}	max. non-repetitive reverse blocking voltage	$T_{VJ} = 25^{\circ}C$			1200	V	
V_{RRM}	max. repetitive reverse blocking voltage	$T_{VJ} = 25^{\circ}C$			1200	V	
I_R	reverse current, drain current	$V_R = 1200 V$	$T_{VJ} = 25^{\circ}C$		100	μA	
		$V_R = 1200 V$	$T_{VJ} = 150^{\circ}C$		0.5	mA	
V_F	forward voltage drop	$I_F = 15 A$	$T_{VJ} = 25^{\circ}C$		3.25	V	
		$I_F = 30 A$			3.96	V	
		$I_F = 15 A$	$T_{VJ} = 150^{\circ}C$		2.06	V	
		$I_F = 30 A$			2.89	V	
I_{FAV}	average forward current	$T_C = 130^{\circ}C$ rectangular $d = 0.5$	$T_{VJ} = 175^{\circ}C$		12	A	
V_{FO}	threshold voltage	} for power loss calculation only	$T_{VJ} = 175^{\circ}C$		1.00	V	
r_F	slope resistance				55	m Ω	
R_{thJC}	thermal resistance junction to case				1.6	K/W	
R_{thCH}	thermal resistance case to heatsink			0.25		K/W	
P_{tot}	total power dissipation		$T_C = 25^{\circ}C$		95	W	
I_{FSM}	max. forward surge current	$t = 10 ms; (50 Hz), sine; V_R = 0 V$	$T_{VJ} = 45^{\circ}C$		90	A	
C_J	junction capacitance	$V_R = 600 V \quad f = 1 MHz$	$T_{VJ} = 25^{\circ}C$		5	pF	
I_{RM}	max. reverse recovery current	} $I_F = 15 A; V_R = 800 V$ $-di_F/dt = 500 A/\mu s$	$T_{VJ} = 25^{\circ}C$		14	A	
			$T_{VJ} = 125^{\circ}C$		23	A	
t_{rr}	reverse recovery time		$T_{VJ} = 25^{\circ}C$		70	ns	
			$T_{VJ} = 125^{\circ}C$		300	ns	



Package TO-263 (D2Pak-HV)		Ratings				
Symbol	Definition	Conditions	min.	typ.	max.	Unit
I_{RMS}	RMS current	per terminal			35	A
T_{VJ}	virtual junction temperature		-55		175	°C
T_{op}	operation temperature		-55		150	°C
T_{stg}	storage temperature		-55		150	°C
Weight				1.5		g
F_C	mounting force with clip		20		60	N
$d_{Spp/APP}$	creepage distance on surface / striking distance through air	terminal to terminal	4.2			mm
$d_{Spb/APb}$		terminal to backside	4.7			mm

Product Marking

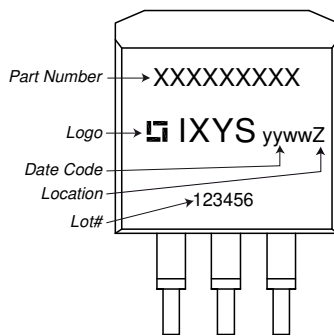

Ordering	Ordering Number	Marking on Product	Delivery Mode	Quantity	Code No.
Standard	DSEP12-12BZ-TRL	DSEP12-12BZ-TRL	Tape & Reel	800	514454
Alternative	DSEP12-12BZ-TUB	DSEP12-12BZ	Tube	50	523901

Similar Part	Package	Voltage class
DSEP12-12AZ	TO-263AB (D2Pak) (2HV)	1200

Equivalent Circuits for Simulation

* on die level

$T_{VJ} = 175^{\circ}C$

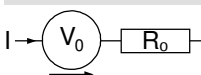

Fast Diode

$V_{0\ max}$	threshold voltage	1	V
$R_{0\ max}$	slope resistance *	52	mΩ



Outlines TO-263 (D2Pak-HV)

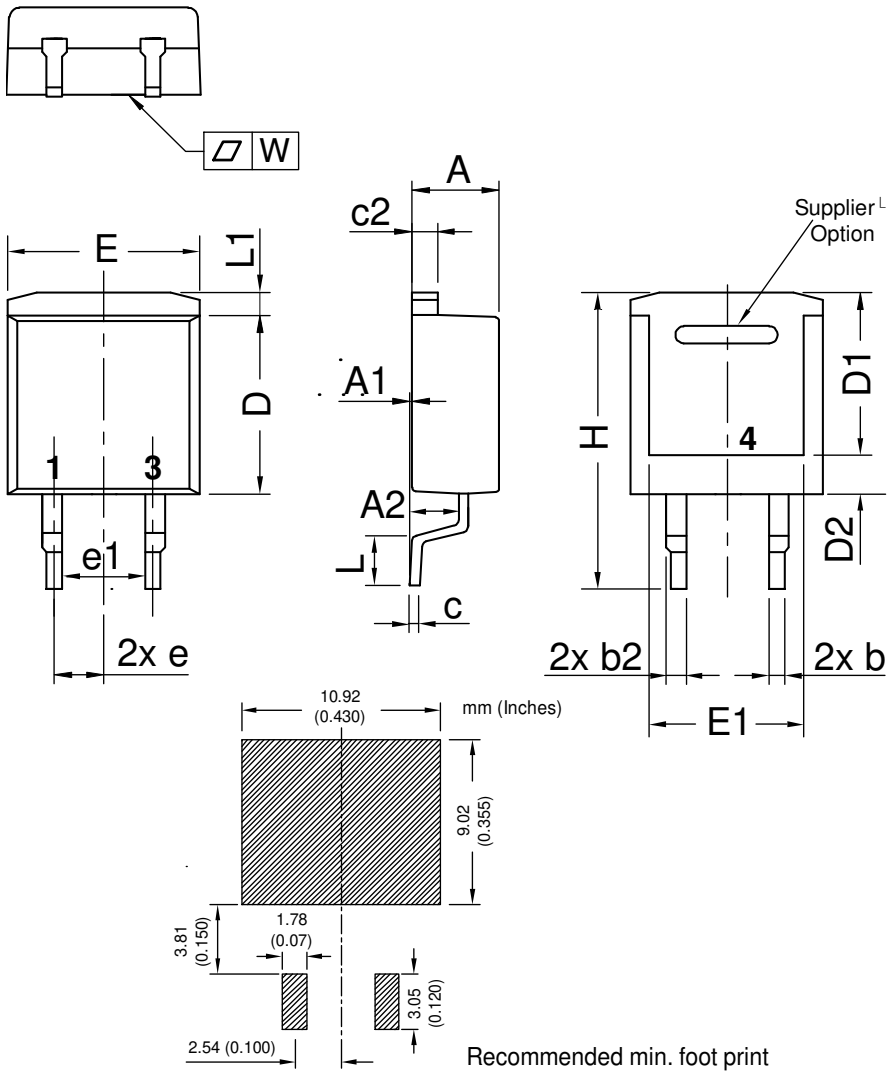

Dim.	Millimeter		Inches	
	min	max	min	max
A	4.06	4.83	0.160	0.190
A1	typ. 0.10		typ. 0.004	
A2	2.41		0.095	
b	0.51	0.99	0.020	0.039
b2	1.14	1.40	0.045	0.055
c	0.40	0.74	0.016	0.029
c2	1.14	1.40	0.045	0.055
D	8.38	9.40	0.330	0.370
D1	8.00	8.89	0.315	0.350
D2	2.3		0.091	
E	9.65	10.41	0.380	0.410
E1	6.22	8.50	0.245	0.335
e	2,54 BSC		0,100 BSC	
e1	4.28		0.169	
H	14.61	15.88	0.575	0.625
L	1.78	2.79	0.070	0.110
L1	1.02	1.68	0.040	0.066
W	typ. 0.02	0.040	typ. 0.0008	0.002

All dimensions conform with and/or within JEDEC standard.

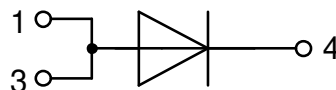

Fast Diode

 Fig. 1 Forward current I_F versus V_F

 Fig. 2 Typ. reverse recov. charge Q_R versus $-di_F/dt$

 Fig. 3 Typ. peak reverse current I_{RM} versus $-di_F/dt$

 Fig. 4 Typ. dynamic parameters Q_R , I_{RM} versus T_{VJ}

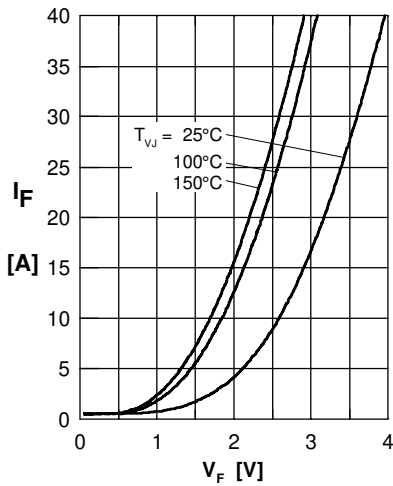
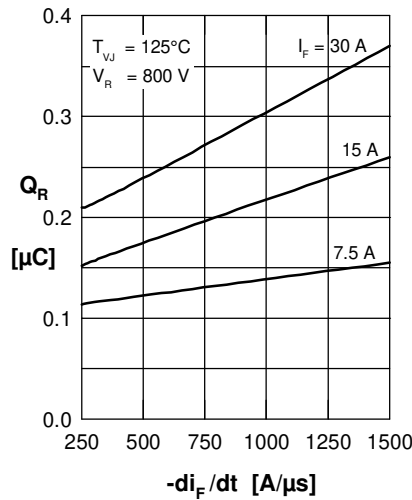
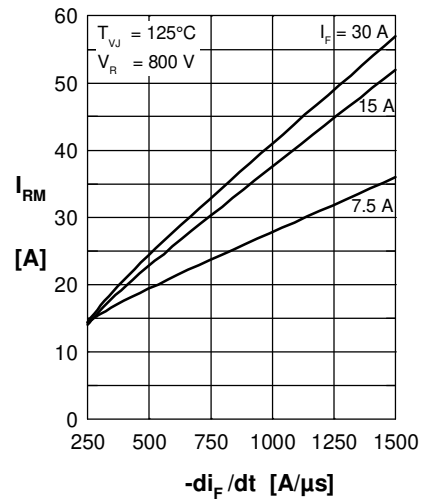
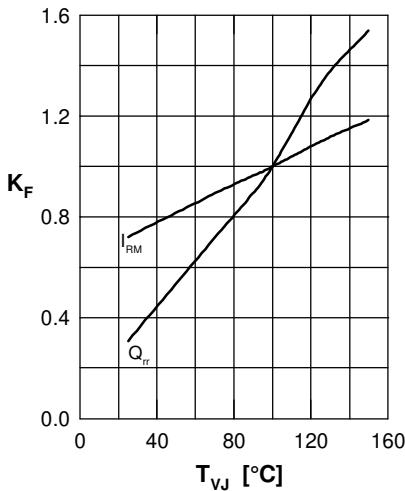
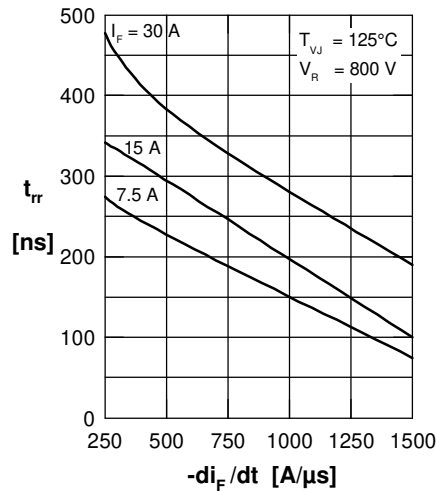
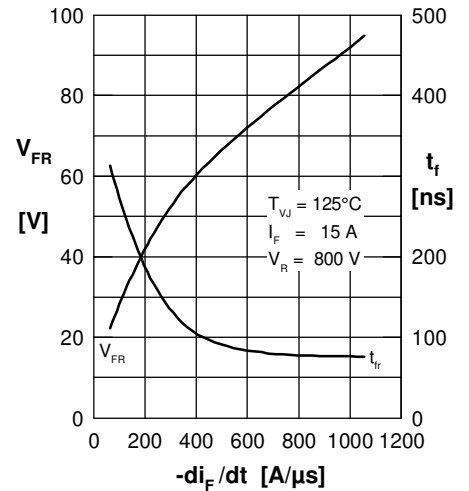
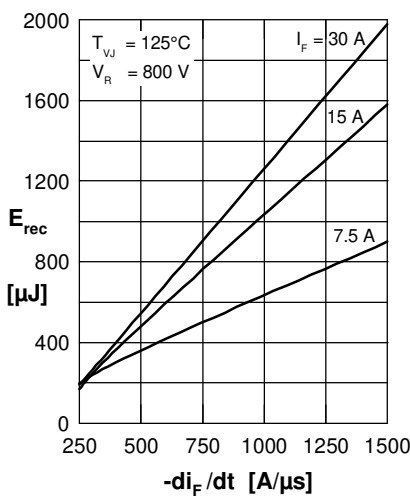
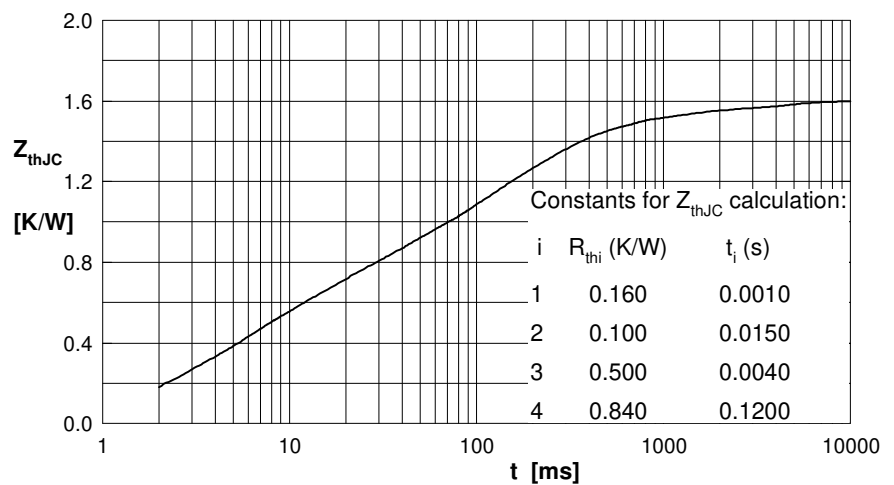
 Fig. 5 Typ. recovery time t_{rr} versus $-di_F/dt$

 Fig. 6 Typ. peak forward voltage V_{FR} and t_{tr} versus di_F/dt

 Fig. 7 Typ. recovery energy E_{rec} versus $-di_F/dt$

Fig. 8 Transient thermal resistance junction to case