

# FRED

$$V_{RRM} = 1200V$$

$$I_{FAV} = 109A$$

$$t_{rr} = 40ns$$

## Fast Recovery Epitaxial Diode Single Diode

### Part number

**DSEI120-12AZ**

Marking on Product: DSEI120-12AZ

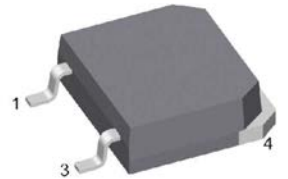

Backside: cathode

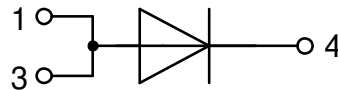

### Features / Advantages:

- Planar passivated chips
- Low leakage current
- Very short recovery time
- Improved thermal behaviour
- Very low  $I_{rm}$ -values
- Very soft recovery behaviour
- Avalanche voltage rated for reliable operation
- Soft reverse recovery for low EMI/RFI
- Low  $I_{rm}$  reduces:
  - Power dissipation within the diode
  - Turn-on loss in the commutating switch

### Applications:

- Antiparallel diode for high frequency switching devices
- Antisaturation diode
- Snubber diode
- Free wheeling diode
- Rectifiers in switch mode power supplies (SMPS)
- Uninterruptible power supplies (UPS)

### Package: TO-268AA (D3Pak-HV)

- Industry standard outline
- RoHS compliant
- Epoxy meets UL 94V-0

### Disclaimer Notice

Information furnished is believed to be accurate and reliable. However, users should independently evaluate the suitability of and test each product selected for their own applications. Littelfuse products are not designed for, and may not be used in, all applications. Read complete Disclaimer Notice at [www.littelfuse.com/disclaimer-electronics](http://www.littelfuse.com/disclaimer-electronics).



Fast Diode				Ratings			
Symbol	Definition	Conditions	min.	typ.	max.	Unit	
$V_{RSM}$	max. non-repetitive reverse blocking voltage	$T_{VJ} = 25^{\circ}C$			1200	V	
$V_{RRM}$	max. repetitive reverse blocking voltage	$T_{VJ} = 25^{\circ}C$			1200	V	
$I_R$	reverse current, drain current	$V_R = 1200 V$	$T_{VJ} = 25^{\circ}C$		300	$\mu A$	
		$V_R = 960 V$	$T_{VJ} = 125^{\circ}C$		20	mA	
$V_F$	forward voltage drop	$I_F = 70 A$	$T_{VJ} = 25^{\circ}C$		1,80	V	
		$I_F = 140 A$				V	
		$I_F = 70 A$	$T_{VJ} = 150^{\circ}C$		1,55	V	
		$I_F = 140 A$				V	
$I_{FAV}$	average forward current	$T_C = 60^{\circ}C$ rectangular $d = 0.5$	$T_{VJ} = 150^{\circ}C$		109	A	
$V_{FO}$	threshold voltage	} for power loss calculation only	$T_{VJ} = 150^{\circ}C$		1,20	V	
$r_F$	slope resistance				4,6	m $\Omega$	
$R_{thJC}$	thermal resistance junction to case				0,35	K/W	
$R_{thCH}$	thermal resistance case to heatsink			0,15		K/W	
$P_{tot}$	total power dissipation		$T_C = 25^{\circ}C$		357	W	
$I_{FSM}$	max. forward surge current	$t = 10 ms; (50 Hz), sine; V_R = 0 V$	$T_{VJ} = 45^{\circ}C$		600	A	
$C_J$	junction capacitance	$V_R = 600V f = 1 MHz$	$T_{VJ} = 25^{\circ}C$		56	pF	
$I_{RM}$	max. reverse recovery current	} $I_F = 75 A; V_R = 350 V$ $-di_F/dt = 200 A/\mu s$	$T_{VJ} = 25^{\circ}C$		tbd	A	
			$T_{VJ} = 100^{\circ}C$		25	A	
$t_{rr}$	reverse recovery time		$T_{VJ} = 25^{\circ}C$		40	ns	
			$T_{VJ} = 100^{\circ}C$		tbd	ns	



Package TO-268AA (D3Pak-HV)			Ratings			
Symbol	Definition	Conditions	min.	typ.	max.	Unit
$I_{RMS}$	RMS current	per terminal			70	A
$T_{VJ}$	virtual junction temperature		-40		150	°C
$T_{op}$	operation temperature		-40		125	°C
$T_{stg}$	storage temperature		-40		150	°C
<b>Weight</b>				4		g
$F_C$	mounting force with clip		20		120	N
$d_{Spp/App}$	creepage distance on surface   striking distance through air	terminal to terminal	9,4			mm
$d_{Spb/Apb}$		terminal to backside	5,6			mm

### Product Marking

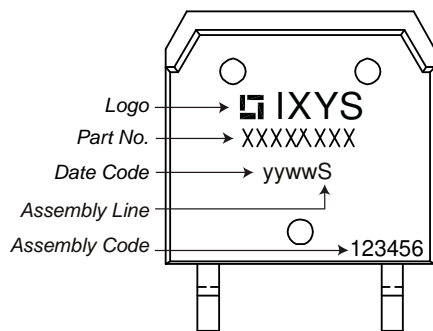

Ordering	Ordering Number	Marking on Product	Delivery Mode	Quantity	Code No.
Standard	DSEI120-12AZ-TUB	DSEI120-12AZ	Tube	30	520332

Similar Part	Package	Voltage class
DSEP90-12AZ	TO-268AA (D3Pak) (2HV)	1200
DSEP60-12AZ	TO-268AA (D3Pak) (2HV)	1200

### Equivalent Circuits for Simulation

\* on die level

$T_{VJ} = 150^{\circ}C$

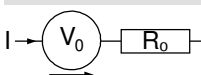

**Fast Diode**

$V_{0\ max}$  threshold voltage

1,2

V

$R_{0\ max}$  slope resistance \*

mΩ



**Outlines TO-268AA (D3Pak-HV)**

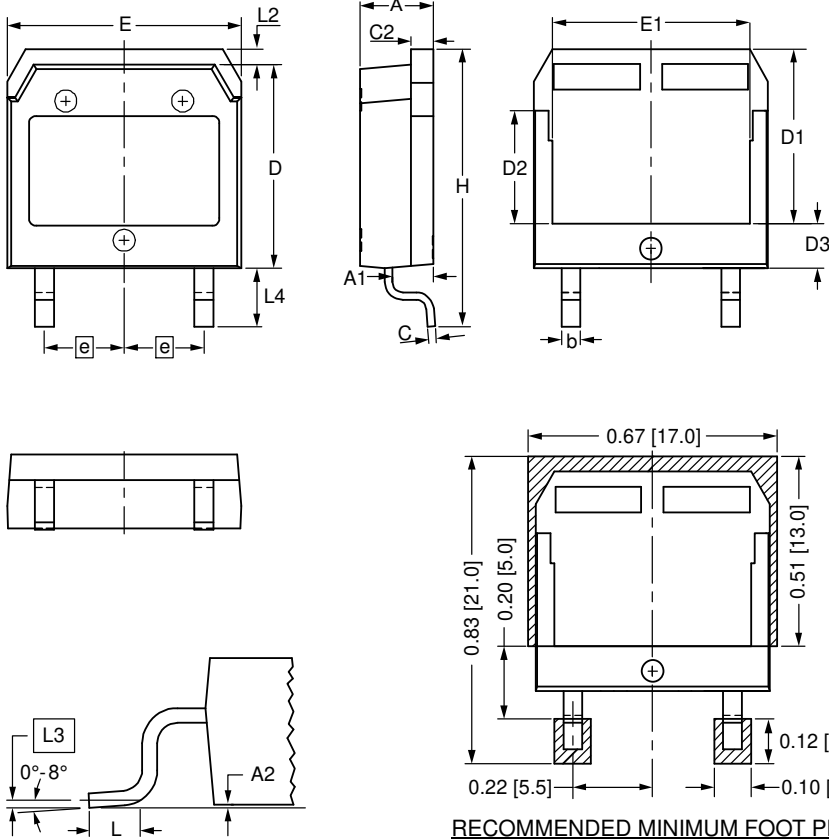

Dim.	Millimeter		Inches	
	min	max	min	max
A	4.90	5.10	0.193	0.201
A1	2.70	2.90	0.106	0.114
A2	0.02	0.25	0.001	0.010
b	1.15	1.45	0.045	0.057
C	0.40	0.65	0.016	0.026
C2	1.45	1.60	0.057	0.063
D	13.80	14.00	0.543	0.551
D1	11.80	12.10	0.465	0.476
D2	7.50	7.80	0.295	0.307
D3	2.90	3.20	0.114	0.126
E	15.85	16.05	0.624	0.632
E1	13.30	13.60	0.524	0.535
e	5.450 BSC		0.215 BSC	
H	18.70	19.10	0.736	0.752
L	1.70	2.00	0.067	0.079
L2	1.00	1.15	0.039	0.045
L3	0.250 BSC		0.010 BSC	
L4	3.80	4.10	0.150	0.161

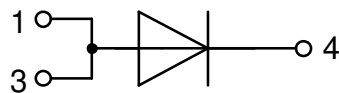

**Fast Diode**

 Fig. 1 Forward current  $I_F$  vs.  $V_F$ 

 Fig. 2 Reverse recovery charge  $Q_r$  versus  $-di_F/dt$ 

 Fig. 3 Peak reverse current  $I_{RM}$  versus  $-di_F/dt$ 

 Fig. 4 Dynamic parameters  $Q_r$ ,  $I_{RM}$  versus  $T_{VJ}$ 

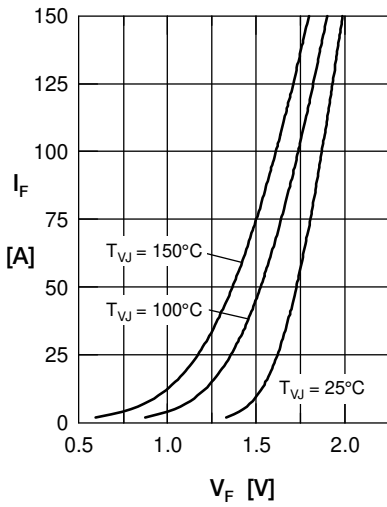
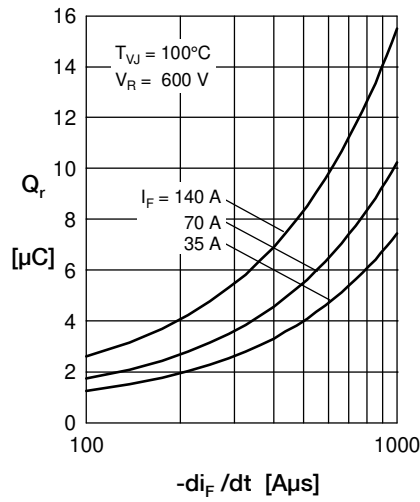
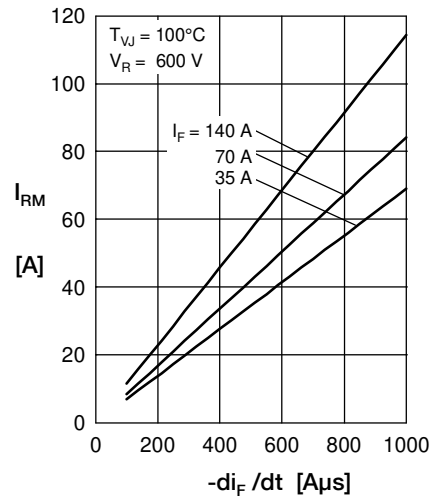
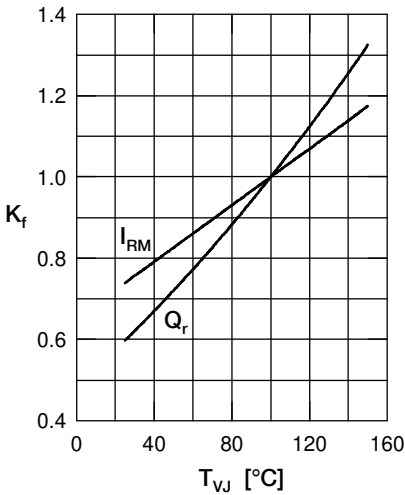
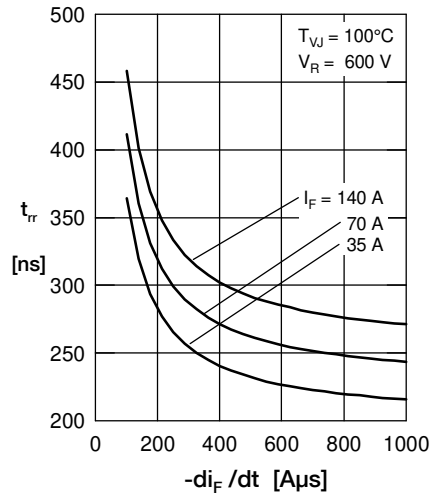
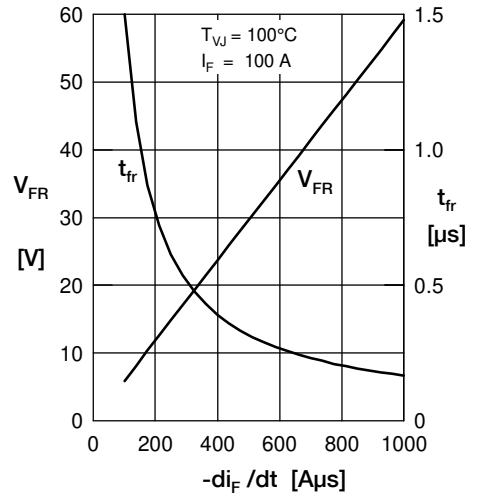
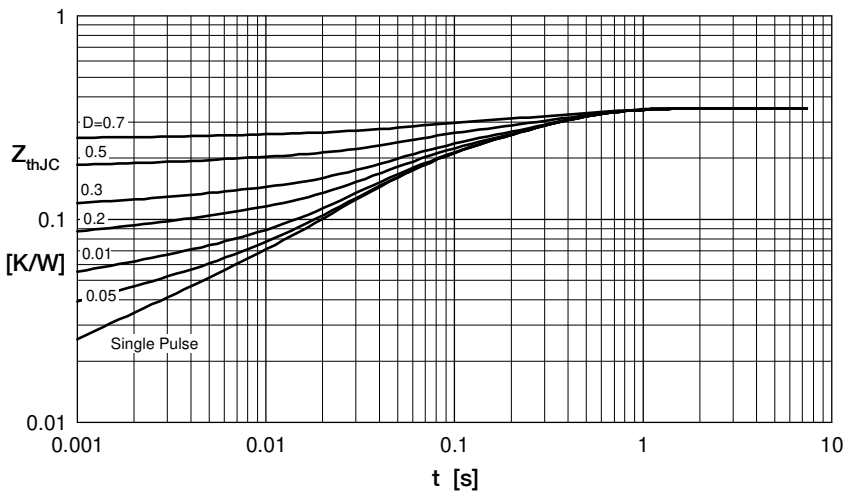
 Fig. 5 Recovery time  $t_{tr}$  versus  $-di_F/dt$ 

 Fig. 6 Peak forward voltage  $V_{FR}$  and  $t_{fr}$  versus  $-di_F/dt$ 

Fig. 7 Transient thermal resistance junction to case at various duty cycles

 Constants for  $Z_{thJC}$  calculation:

i	$R_{thi}$ (K/W)	$t_i$ (s)
1	0.017	0.00038
2	0.0184	0.0026
3	0.1296	0.0387
4	0.185	0.274