



# Schottky Diode Gen <sup>2</sup>

$V_{RRM} = 100\text{ V}$

$I_{FAV} = 2 \times 25\text{ A}$

$V_F = 0.72\text{ V}$

High Performance Schottky Diode  
Low Loss and Soft Recovery  
Common Cathode

Part number

**DSA50C100HB**

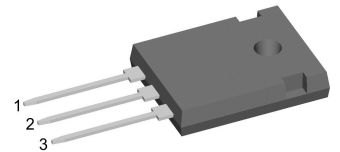

Backside: cathode

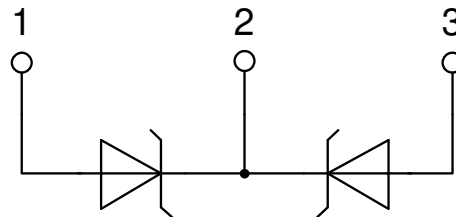

**Features / Advantages:**

- Very low  $V_f$
- Extremely low switching losses
- Low  $I_{rm}$  values
- Improved thermal behaviour
- High reliability circuit operation
- Low voltage peaks for reduced protection circuits
- Low noise switching

**Applications:**

- Rectifiers in switch mode power supplies (SMPS)
- Free wheeling diode in low voltage converters

**Package: TO-247**

- Industry standard outline
- RoHS compliant
- Epoxy meets UL 94V-0

**Disclaimer Notice**

Information furnished is believed to be accurate and reliable. However, users should independently evaluate the suitability of and test each product selected for their own applications. Littelfuse products are not designed for, and may not be used in, all applications. Read complete Disclaimer Notice at [www.littelfuse.com/disclaimer-electronics](http://www.littelfuse.com/disclaimer-electronics).



Schottky				Ratings			
Symbol	Definition	Conditions		min.	typ.	max.	Unit
$V_{RSM}$	max. non-repetitive reverse blocking voltage					100	V
$V_{RRM}$	max. repetitive reverse blocking voltage					100	V
$I_R$	reverse current, drain current	$V_R = 100\text{ V}$		$T_{VJ} = 25^\circ\text{C}$		450	$\mu\text{A}$
		$V_R = 100\text{ V}$		$T_{VJ} = 125^\circ\text{C}$		5	mA
$V_F$	forward voltage drop	$I_F = 25\text{ A}$		$T_{VJ} = 25^\circ\text{C}$		0.90	V
		$I_F = 50\text{ A}$				1.07	V
		$I_F = 25\text{ A}$		$T_{VJ} = 125^\circ\text{C}$		0.72	V
		$I_F = 50\text{ A}$				0.90	V
$I_{FAV}$	average forward current	$T_C = 155^\circ\text{C}$	rectangular	$T_{VJ} = 175^\circ\text{C}$		25	A
$V_{F0}$	threshold voltage	} for power loss calculation only				0.45	V
$r_F$	slope resistance					7.3	m $\Omega$
$R_{thJC}$	thermal resistance junction to case					0.95	K/W
$R_{thCH}$	thermal resistance case to heatsink					0.3	K/W
$P_{tot}$	total power dissipation			$T_C = 25^\circ\text{C}$		160	W
$I_{FSM}$	max. forward surge current	$t = 10\text{ ms}; (50\text{ Hz}), \text{ sine}; V_R = 0\text{ V}$		$T_{VJ} = 45^\circ\text{C}$		440	A
$C_J$	junction capacitance	$V_R = 12\text{ V}$	$f = 1\text{ MHz}$	$T_{VJ} = 25^\circ\text{C}$		289	pF



Package TO-247			Ratings			
Symbol	Definition	Conditions	min.	typ.	max.	Unit
$I_{RMS}$	RMS current	per terminal <sup>1)</sup>			50	A
$T_{VJ}$	virtual junction temperature		-55		175	°C
$T_{op}$	operation temperature		-55		150	°C
$T_{stg}$	storage temperature		-55		150	°C
<b>Weight</b>				6		g
$M_D$	mounting torque		0.8		1.2	Nm
$F_C$	mounting force with clip		20		120	N

**Product Marking**

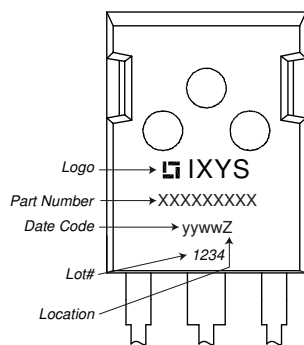

**Part description**

- D = Diode
- S = Schottky Diode
- A = low VF
- 50 = Current Rating [A]
- C = Common Cathode
- 100 = Reverse Voltage [V]
- HB = TO-247AD (3)

Ordering	Ordering Number	Marking on Product	Delivery Mode	Quantity	Code No.
Standard	DSA50C100HB	DSA50C100HB	Tube	30	502774

Similar Part	Package	Voltage class
DSA50C100QB	TO-3P (3)	100
DSA60C100PB	TO-220AB (3)	100

**Equivalent Circuits for Simulation**

*\* on die level*

$T_{VJ} = 175^{\circ}C$

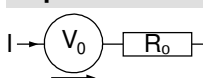

**Schottky**

$V_{0\ max}$	threshold voltage	0.45	V
$R_{0\ max}$	slope resistance *	4.7	mΩ



**Outlines TO-247**



Sym.	Inches		Millimeter	
	min.	max.	min.	max.
A	0.185	0.209	4.70	5.30
A1	0.087	0.102	2.21	2.59
A2	0.059	0.098	1.50	2.49
D	0.819	0.845	20.79	21.45
E	0.610	0.640	15.48	16.24
E2	0.170	0.216	4.31	5.48
e	0.215	BSC	5.46	BSC
L	0.780	0.800	19.80	20.30
L1	-	0.177	-	4.49
Ø P	0.140	0.144	3.55	3.65
Q	0.212	0.244	5.38	6.19
S	-	0.242 BSC	-	6.14 BSC
b	0.039	0.055	0.99	1.40
b2	0.065	0.094	1.65	2.39
b4	0.102	0.135	2.59	3.43
c	0.015	0.035	0.38	0.89
D1	0.515	-	13.07	-
D2	0.020	0.053	0.51	1.35
E1	0.530	-	13.45	-
Ø P1	-	0.29	-	7.39

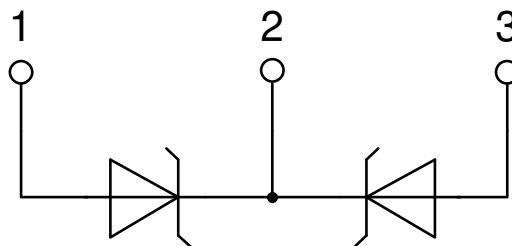



**Schottky**

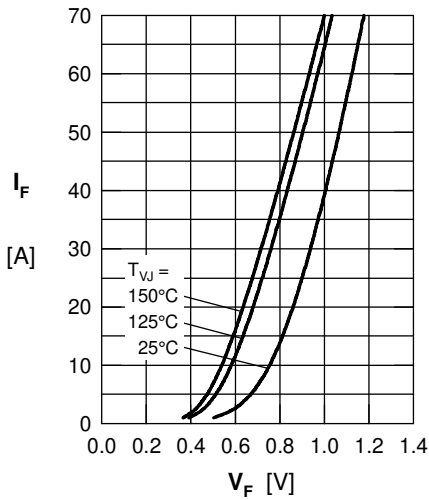

Fig. 1 Maximum forward voltage drop characteristics

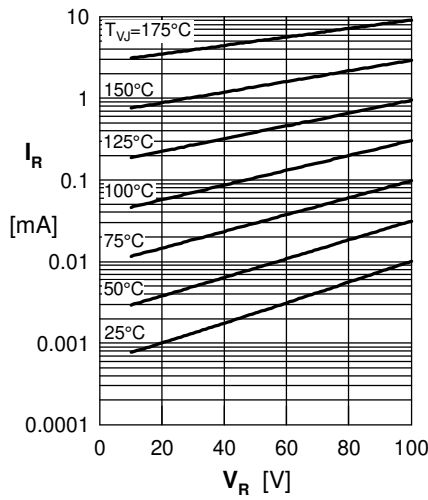

Fig. 2 Typ. reverse current  $I_R$  vs. reverse voltage  $V_R$

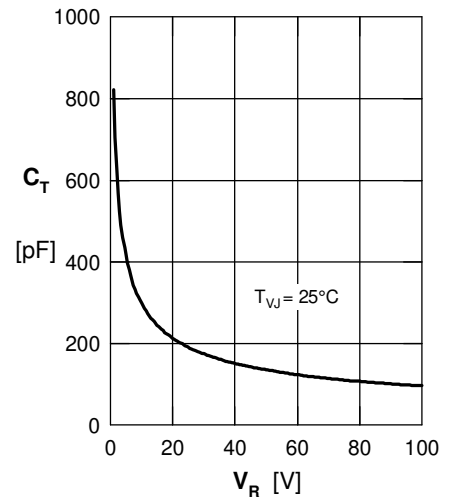

Fig. 3 Typ. junction capacitance  $C_T$  vs. reverse voltage  $V_R$

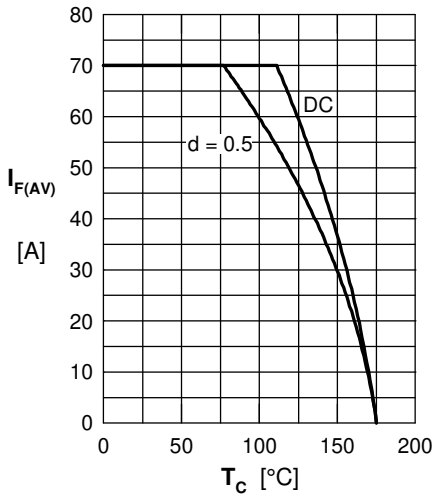

Fig. 4 Average forward current  $I_{F(AV)}$  vs. case temperature  $T_C$

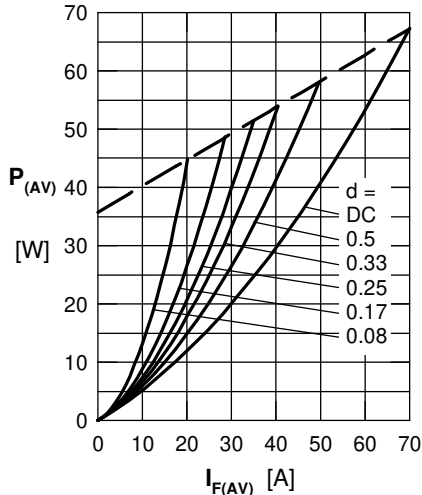

Fig. 5 Forward power loss characteristics

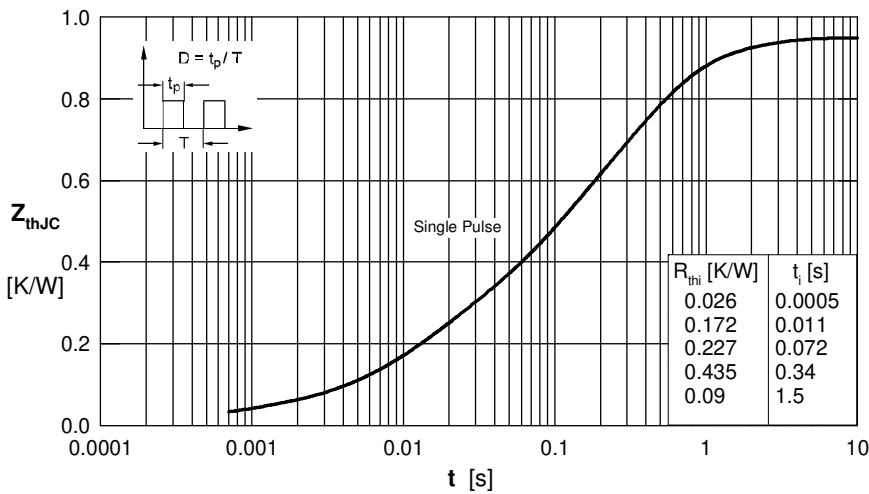

Fig. 6 Transient thermal impedance junction to case

Note: All curves are per diode