

High Voltage Standard Rectifier

$$V_{RRM} = 2200 \text{ V}$$

$$I_{FAV} = 30 \text{ A}$$

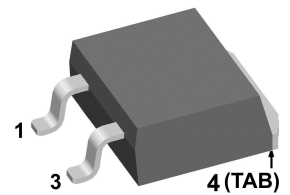
$$V_F = 1.24 \text{ V}$$

Single Diode

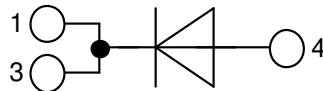
Part number

DNA30EM2200PZ

Marking on Product: DNA30EM2200PZ



Backside: anode



Features / Advantages:

- Planar passivated chips
- Very low leakage current
- Very low forward voltage drop
- Improved thermal behaviour

Applications:

- Diode for main rectification
- For single and three phase bridge configurations

Package: TO-263 (D2Pak-HV)

- Industry standard outline
- RoHS compliant
- Epoxy meets UL 94V-0
- High creepage distance between terminals

Disclaimer Notice

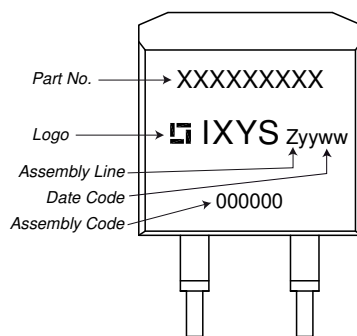
Information furnished is believed to be accurate and reliable. However, users should independently evaluate the suitability of and test each product selected for their own applications. Littelfuse products are not designed for, and may not be used in, all applications. Read complete Disclaimer Notice at www.littelfuse.com/disclaimer-electronics.

Rectifier				Ratings			
Symbol	Definition	Conditions		min.	typ.	max.	Unit
V_{RSM}	max. non-repetitive reverse blocking voltage					2300	V
V_{RRM}	max. repetitive reverse blocking voltage					2200	V
I_R	reverse current	$V_R = 2200$ V		$T_{VJ} = 25^\circ\text{C}$		40	μA
		$V_R = 2200$ V		$T_{VJ} = 150^\circ\text{C}$		1.5	mA
V_F	forward voltage drop	$I_F = 30$ A		$T_{VJ} = 25^\circ\text{C}$		1.26	V
		$I_F = 60$ A				1.53	V
		$I_F = 30$ A		$T_{VJ} = 150^\circ\text{C}$		1.24	V
		$I_F = 60$ A				1.63	V
I_{FAV}	average forward current	$T_C = 140^\circ\text{C}$	rectangular	$T_{VJ} = 175^\circ\text{C}$		30	A
V_{FO}	threshold voltage			$T_{VJ} = 175^\circ\text{C}$		0.83	V
r_F	slope resistance					13.4	m Ω
R_{thJC}	thermal resistance junction to case					0.7	K/W
R_{thCH}	thermal resistance case to heatsink				0.25		K/W
P_{tot}	total power dissipation			$T_C = 25^\circ\text{C}$		210	W
I_{FSM}	max. forward surge current	$t = 10$ ms; (50 Hz), sine		$T_{VJ} = 45^\circ\text{C}$		370	A
		$t = 8,3$ ms; (60 Hz), sine		$V_R = 0$ V		400	A
		$t = 10$ ms; (50 Hz), sine		$T_{VJ} = 150^\circ\text{C}$		315	A
		$t = 8,3$ ms; (60 Hz), sine		$V_R = 0$ V		340	A
I^2t	value for fusing	$t = 10$ ms; (50 Hz), sine		$T_{VJ} = 45^\circ\text{C}$		685	A ² s
		$t = 8,3$ ms; (60 Hz), sine		$V_R = 0$ V		665	A ² s
		$t = 10$ ms; (50 Hz), sine		$T_{VJ} = 150^\circ\text{C}$		495	A ² s
		$t = 8,3$ ms; (60 Hz), sine		$V_R = 0$ V		480	A ² s
C_J	junction capacitance	$V_R = 700$ V; $f = 1$ MHz		$T_{VJ} = 25^\circ\text{C}$		7	pF



Package TO-263 (D2Pak-HV)		Ratings				
Symbol	Definition	Conditions	min.	typ.	max.	Unit
I_{RMS}	RMS current	per terminal			35	A
T_{VJ}	virtual junction temperature		-55		175	°C
T_{op}	operation temperature		-55		150	°C
T_{stg}	storage temperature		-55		150	°C
Weight				1.5		g
F_C	mounting force with clip		20		60	N
$d_{Spp/App}$	creepage distance on surface / striking distance through air	terminal to terminal	4.2			mm
$d_{Spb/Apb}$		terminal to backside	4.7			mm

Product Marking



Part description

- D = Diode
- N = High Voltage Standard Rectifier
- A = (>= 2000V)
- 30 = Current Rating [A]
- EM = Single Diode
- 2200 = Reverse Voltage [V]
- PZ = TO-263AB (D2Pak) (2HV)

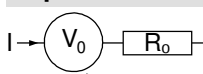
Ordering	Ordering Number	Marking on Product	Delivery Mode	Quantity	Code No.
Standard	DNA30EM2200PZ-TRL	DNA30EM2200PZ	Tape & Reel	800	514467
Alternative	DNA30EM2200PZ-TUB	DNA30EM2200PZ	Tube	50	525368

Similar Part	Package	Voltage class
DNA30E2200PZ	TO-263AB (D2Pak) (2HV)	2200
DNA30E2200PA	TO-220AC	2200
DNA30E2200FE	i4-Pac (2HV)	2200
DNA30E2200IY	TO-262 (I2Pak) (2HV)	2200

Equivalent Circuits for Simulation

* on die level

$T_{VJ} = 175\text{ °C}$

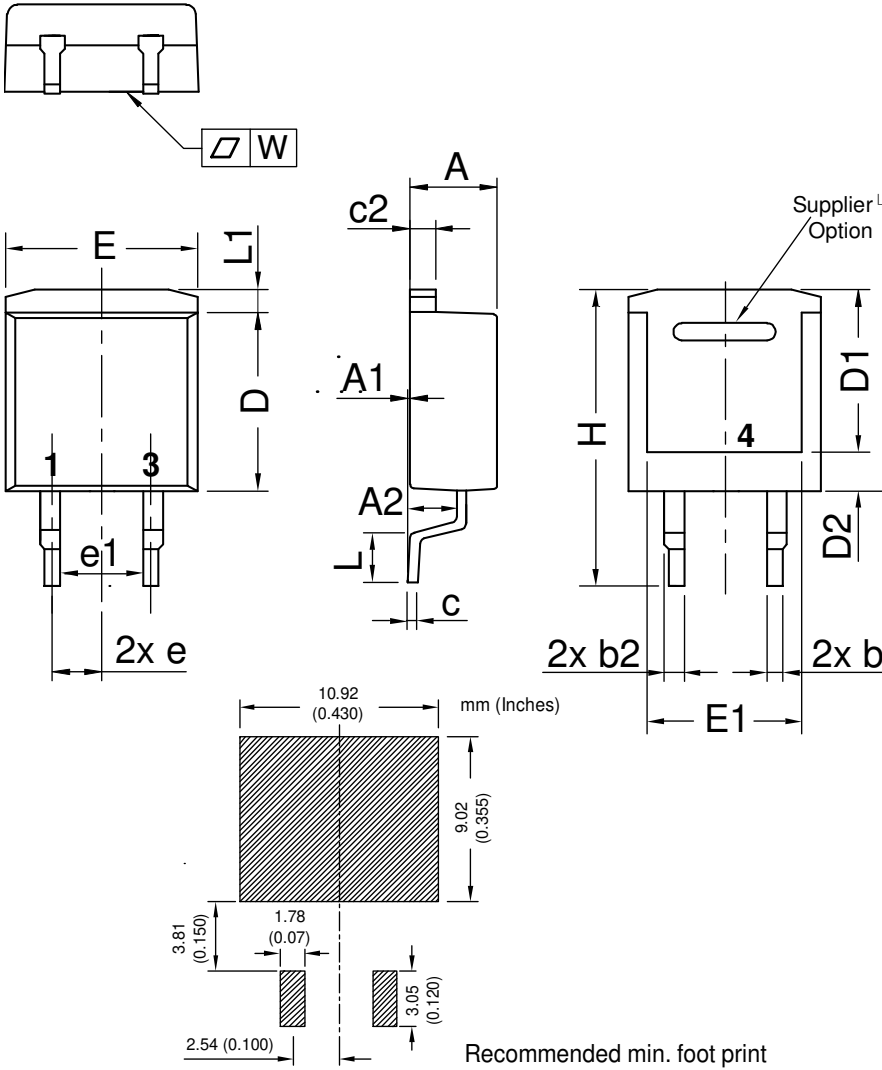


Rectifier

$V_{0\ max}$	threshold voltage	0.83	V
$R_{0\ max}$	slope resistance *	10.2	mΩ

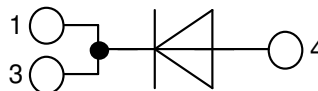


Outlines TO-263 (D2Pak-HV)



Dim.	Millimeter		Inches	
	min	max	min	max
A	4.06	4.83	0.160	0.190
A1	typ. 0.10		typ. 0.004	
A2	2.41		0.095	
b	0.51	0.99	0.020	0.039
b2	1.14	1.40	0.045	0.055
c	0.40	0.74	0.016	0.029
c2	1.14	1.40	0.045	0.055
D	8.38	9.40	0.330	0.370
D1	8.00	8.89	0.315	0.350
D2	2.3		0.091	
E	9.65	10.41	0.380	0.410
E1	6.22	8.50	0.245	0.335
e	2,54 BSC		0,100 BSC	
e1	4.28		0.169	
H	14.61	15.88	0.575	0.625
L	1.78	2.79	0.070	0.110
L1	1.02	1.68	0.040	0.066
W	typ. 0.02	0.040	typ. 0.0008	0.002

All dimensions conform with and/or within JEDEC standard.



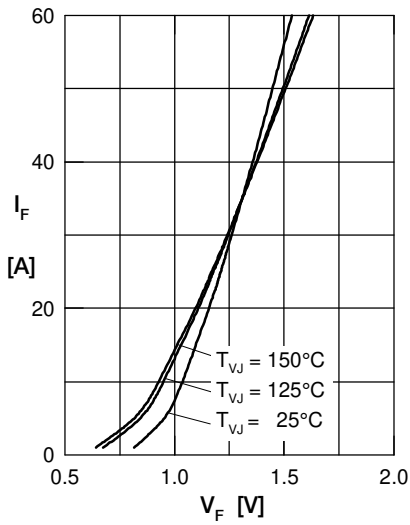
Rectifier


Fig. 1 Forward current versus voltage drop per diode

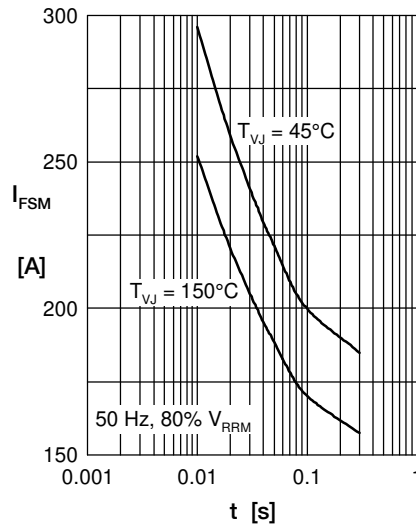


Fig. 2 Surge overload current

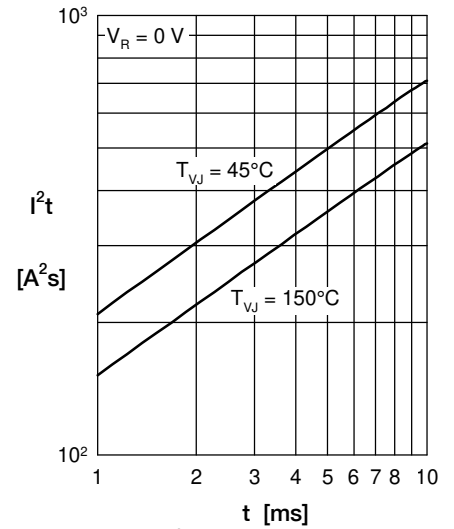
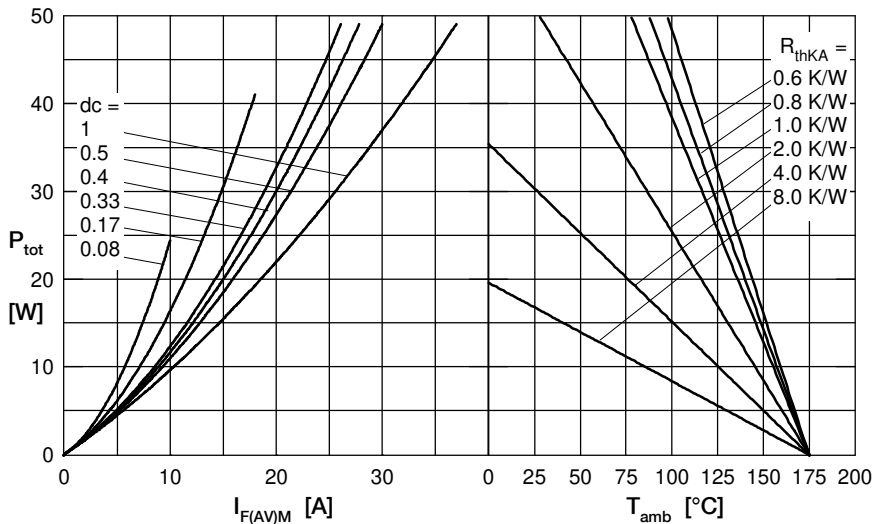

 Fig. 3 I^2t versus time per diode


Fig. 4 Power dissipation vs. direct output current & ambient temperature

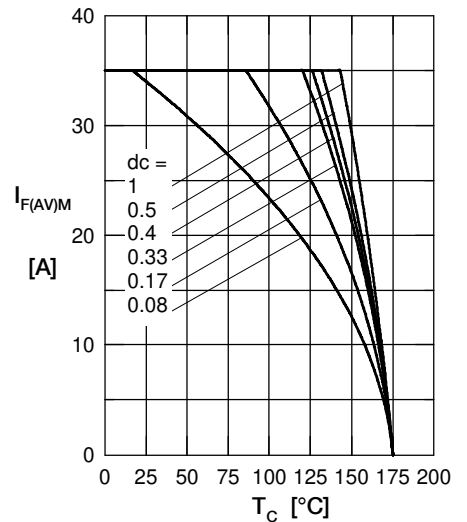


Fig. 5 Max. forward current versus case temperature

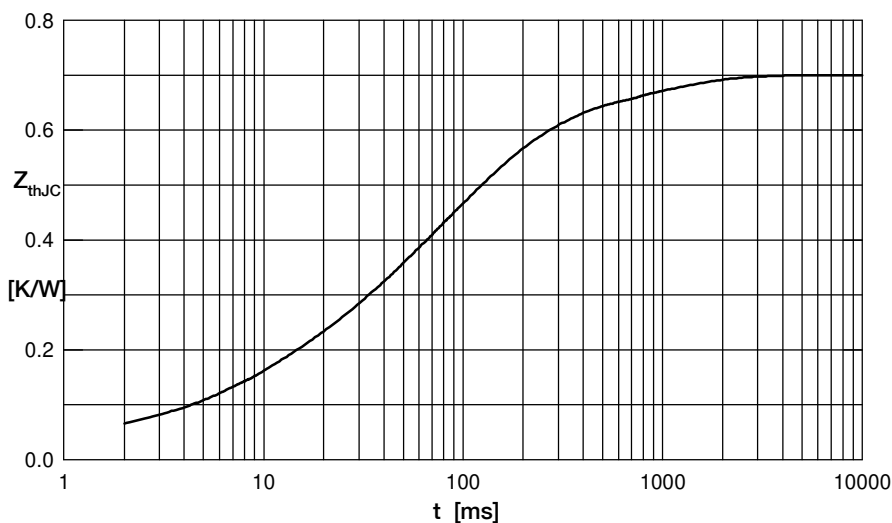


Fig. 6 Transient thermal impedance junction to case

 Constants for Z_{thJC} calculation:

i	R_{thi} (K/W)	t_i (s)
1	0.03	0.0003
2	0.072	0.0065
3	0.131	0.027
4	0.367	0.105
5	0.1	0.8