

# High Voltage Standard Rectifier

$$V_{RRM} = 2200\text{ V}$$

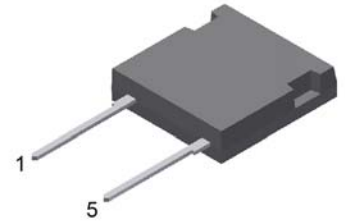
$$I_{FAV} = 30\text{ A}$$

$$V_F = 1,22\text{ V}$$

## Single Diode

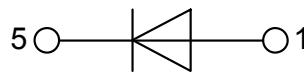
Part number

**DNA30E2200FE**



Backside: isolated

 E72873



### Features / Advantages:

- Planar passivated chips
- Very low leakage current
- Very low forward voltage drop
- Improved thermal behaviour

### Applications:

- Diode for main rectification
- For single and three phase bridge configurations

### Package: i4-Pac

- Isolation Voltage: 3000 V~
- Industry convenient outline
- RoHS compliant
- Epoxy meets UL 94V-0
- Soldering pins for PCB mounting
- Backside: DCB ceramic
- Reduced weight
- Advanced power cycling

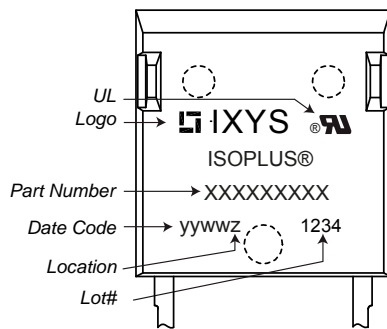
### Disclaimer Notice

Information furnished is believed to be accurate and reliable. However, users should independently evaluate the suitability of and test each product selected for their own applications. Littelfuse products are not designed for, and may not be used in, all applications. Read complete Disclaimer Notice at [www.littelfuse.com/disclaimer-electronics](http://www.littelfuse.com/disclaimer-electronics).

Rectifier				Ratings			
Symbol	Definition	Conditions	min.	typ.	max.	Unit	
$V_{RSM}$	max. non-repetitive reverse blocking voltage	$T_{VJ} = 25^{\circ}C$			2300	V	
$V_{RRM}$	max. repetitive reverse blocking voltage	$T_{VJ} = 25^{\circ}C$			2200	V	
$I_R$	reverse current	$V_R = 2200 V$	$T_{VJ} = 25^{\circ}C$		40	$\mu A$	
		$V_R = 2200 V$	$T_{VJ} = 150^{\circ}C$		1,5	mA	
$V_F$	forward voltage drop	$I_F = 30 A$	$T_{VJ} = 25^{\circ}C$		1,25	V	
					1,50	V	
		$I_F = 60 A$	$T_{VJ} = 150^{\circ}C$		1,22	V	
					1,59	V	
$I_{FAV}$	average forward current	$T_C = 110^{\circ}C$ rectangular $d = 0.5$	$T_{VJ} = 175^{\circ}C$		30	A	
$V_{F0}$	threshold voltage		$T_{VJ} = 175^{\circ}C$		0,83	V	
$r_F$	slope resistance				12,8	m $\Omega$	
$R_{thJC}$	thermal resistance junction to case				1,35	K/W	
$R_{thCH}$	thermal resistance case to heatsink			0,2		K/W	
$P_{tot}$	total power dissipation		$T_C = 25^{\circ}C$		110	W	
$I_{FSM}$	max. forward surge current	$t = 10 \text{ ms; (50 Hz), sine}$	$T_{VJ} = 45^{\circ}C$		370	A	
		$t = 8,3 \text{ ms; (60 Hz), sine}$	$V_R = 0 V$		400	A	
		$t = 10 \text{ ms; (50 Hz), sine}$	$T_{VJ} = 150^{\circ}C$		315	A	
		$t = 8,3 \text{ ms; (60 Hz), sine}$	$V_R = 0 V$		340	A	
$I^2t$	value for fusing	$t = 10 \text{ ms; (50 Hz), sine}$	$T_{VJ} = 45^{\circ}C$		685	A <sup>2</sup> s	
		$t = 8,3 \text{ ms; (60 Hz), sine}$	$V_R = 0 V$		665	A <sup>2</sup> s	
		$t = 10 \text{ ms; (50 Hz), sine}$	$T_{VJ} = 150^{\circ}C$		495	A <sup>2</sup> s	
		$t = 8,3 \text{ ms; (60 Hz), sine}$	$V_R = 0 V$		480	A <sup>2</sup> s	
$C_J$	junction capacitance	$V_R = 700 V; f = 1 \text{ MHz}$	$T_{VJ} = 25^{\circ}C$		7	pF	

Package i4-Pac			Ratings			
Symbol	Definition	Conditions	min.	typ.	max.	Unit
$I_{RMS}$	RMS current	per terminal			70	A
$T_{VJ}$	virtual junction temperature		-55		175	°C
$T_{op}$	operation temperature		-55		150	°C
$T_{stg}$	storage temperature		-55		150	°C
<b>Weight</b>				5,5		g
$F_C$	mounting force with clip		20		120	N
$d_{Spp/App}$	creepage distance on surface   striking distance through air	terminal to terminal	13,8			mm
$d_{Spb/Apb}$		terminal to backside	5,1			mm
$V_{ISOL}$	isolation voltage	t = 1 second	3000			V
		t = 1 minute	2500			V

### Product Marking



### Part description

D = Diode  
 N = High Voltage Standard Rectifier  
 A = ( $\geq 2000V$ )  
 30 = Current Rating [A]  
 E = Single Diode  
 2200 = Reverse Voltage [V]  
 FE = i4-Pac (2HV)

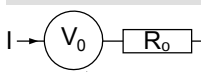
Ordering	Ordering Number	Marking on Product	Delivery Mode	Quantity	Code No.
Standard	DNA30E2200FE	DNA30E2200FE	Tube	25	508861

Similar Part	Package	Voltage class
DNA30E2200PA	TO-220AC	2200
DNA30E2200PZ	TO-263AB (D2Pak) (2HV)	2200
DNA30EM2200PZ	TO-263AB (D2Pak) (2HV)	2200
DNA30E2200IY	TO-262 (2HV) (I2PAK)	2200

### Equivalent Circuits for Simulation

\* on die level

$T_{VJ} = 175^\circ C$

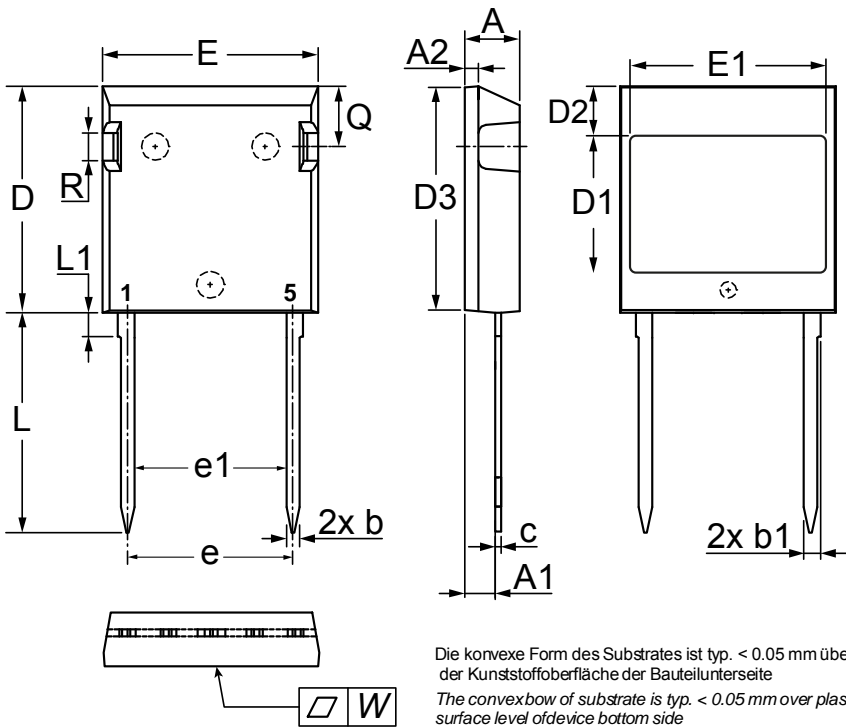


Rectifier

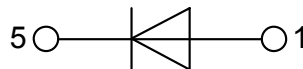
$V_{0\ max}$	threshold voltage	0,83	V
$R_{0\ max}$	slope resistance *	10,2	mΩ



Outlines i4-Pac



Dim.	Millimeter		Inches	
	min	max	min	max
A	4.83	5.21	0.190	0.205
A1	2.59	3.00	0.102	0.118
A2	1.17	2.16	0.046	0.085
b	1.14	1.40	0.045	0.055
b1	1.47	1.73	0.058	0.068
c	0.51	0.74	0.020	0.029
D	20.80	21.34	0.819	0.840
D1	11.70	12.30	0.460	0.484
D2	5.50	6.10	0.216	0.240
D3	20.30	20.70	0.799	0.815
E	19.56	20.29	0.770	0.799
E1	17.50	18.10	0.689	0.712
e	15.24	BSC	0.600	BSC
e1	14.10	BSC	0.555	BSC
L	19.81	21.34	0.780	0.840
L1	2.11	2.59	0.083	0.102
Q	5.33	6.20	0.210	0.244
R	2.54	4.57	0.100	0.180
W	-	0.10	-	0.004



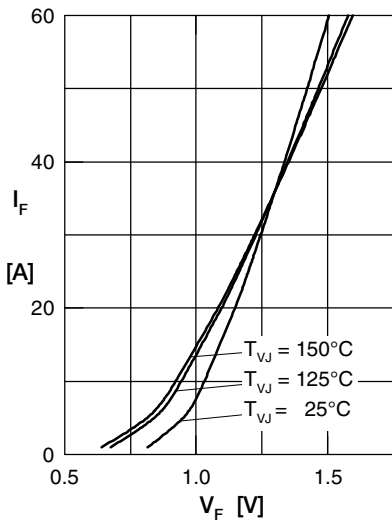
**Rectifier**


Fig. 1 Forward current versus voltage drop per diode

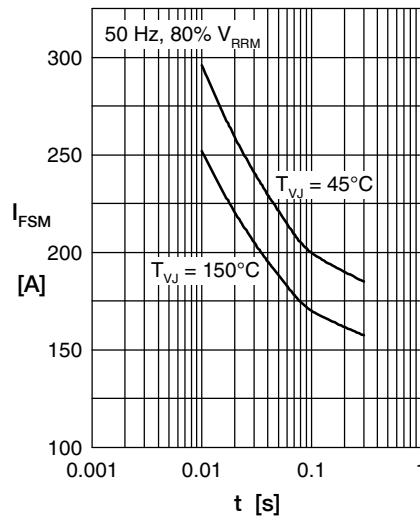


Fig. 2 Surge overload current

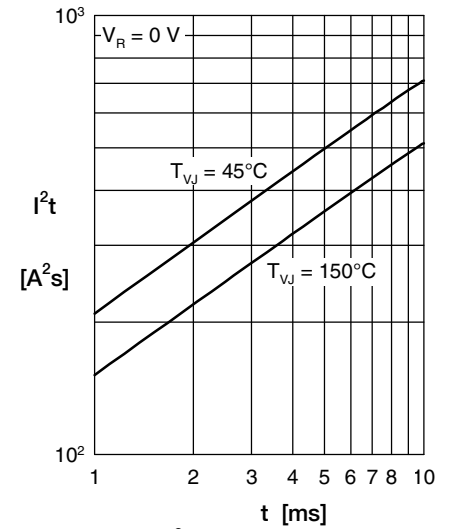
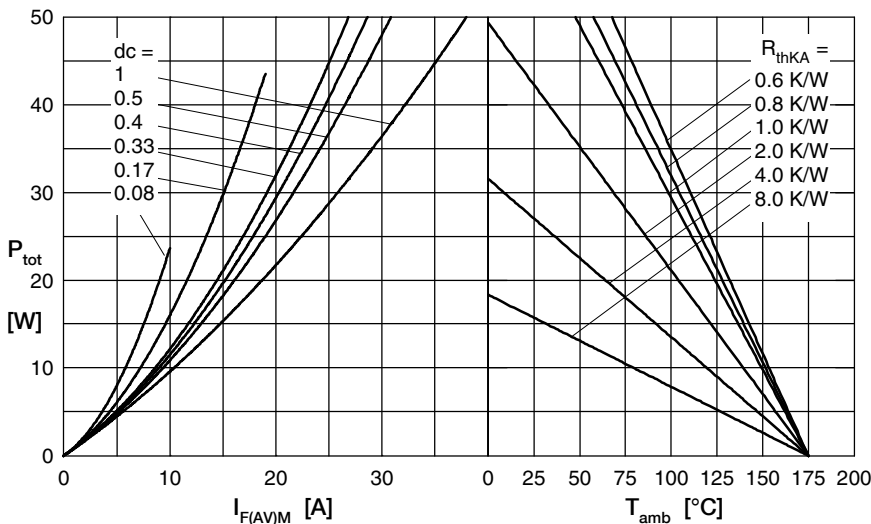

 Fig. 3  $I^2t$  versus time per diode


Fig. 4 Power dissipation versus direct output current &amp; ambient temperature

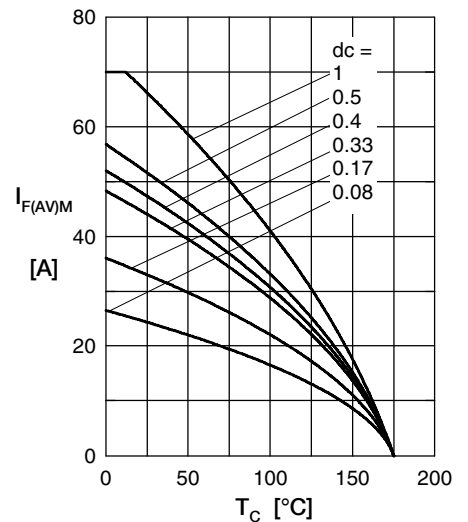


Fig. 5 Max. forward current versus case temperature

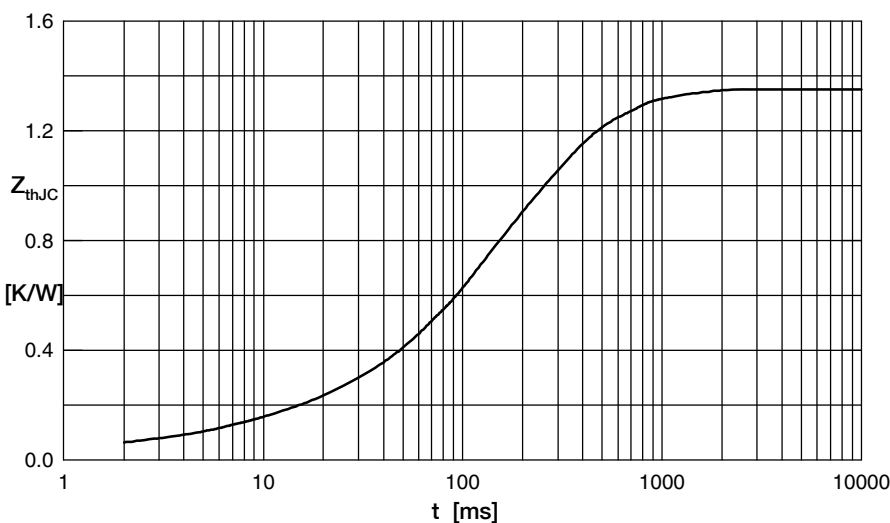


Fig. 6 Transient thermal impedance junction to case

 Constants for  $Z_{thJC}$  calculation:

i	$R_{thi}$ (K/W)	$t_i$ (s)
1	0.03	0.0003
2	0.072	0.0065
3	0.122	0.083
4	0.736	0.152
5	0.39	0.4