



Standard Rectifier

3~ Rectifier	
V_{RRM}	= 1800 V
I_{DAV}	= 90 A
I_{FSM}	= 350 A

ISOPLUS™
Surface Mount Power Device
3~ Rectifier Bridge

Part number

DMA90U1800LB

Marking on Product: DMA90U1800LB

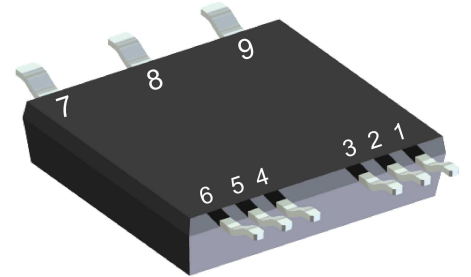

Backside: isolated

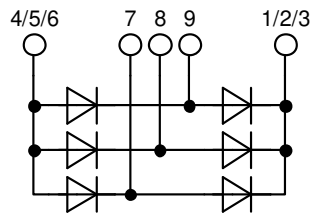
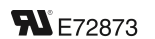

Features / Advantages:

- Rectifier diode
- Isolated back surface
- Low coupling capacity between pins and heatsink
- Enlarged creepage towards heatsink
- Application friendly pinout
- Low inductive current path
- High reliability

Applications:

- Line rectifying 50/60 Hz
- Drives
- SMPS
- UPS

Package: SMPD

- Isolation Voltage: 3000 V~
- Industry convenient outline
- RoHS compliant
- Epoxy meets UL 94V-0
- Soldering pins for PCB mounting
- Backside: DCB ceramic
- Reduced weight
- Advanced power cycling

Disclaimer Notice

Information furnished is believed to be accurate and reliable. However, users should independently evaluate the suitability of and test each product selected for their own applications. Littelfuse products are not designed for, and may not be used in, all applications. Read complete Disclaimer Notice at www.littelfuse.com/disclaimer-electronics.

Rectifier				Ratings			
Symbol	Definition	Conditions		min.	typ.	max.	Unit
V_{RSM}	max. non-repetitive reverse blocking voltage					1900	V
V_{RRM}	max. repetitive reverse blocking voltage					1800	V
I_R	reverse current	$V_R = 1800$ V	$T_{VJ} = 25^\circ\text{C}$			40	μA
		$V_R = 1800$ V	$T_{VJ} = 150^\circ\text{C}$			1.5	mA
V_F	forward voltage drop	$I_F = 30$ A	$T_{VJ} = 25^\circ\text{C}$			1.26	V
		$I_F = 90$ A				1.79	V
		$I_F = 30$ A	$T_{VJ} = 150^\circ\text{C}$			1.20	V
		$I_F = 90$ A				1.93	V
I_{DAV}	bridge output current	$T_C = 110^\circ\text{C}$ rectangular	$T_{VJ} = 175^\circ\text{C}$ $d = \frac{1}{3}$			90	A
V_{FO}	threshold voltage	} for power loss calculation only				0.81	V
r_F	slope resistance					12.7	m Ω
R_{thJC}	thermal resistance junction to case					1.1	K/W
R_{thCH}	thermal resistance case to heatsink				0.4		K/W
P_{tot}	total power dissipation			$T_C = 25^\circ\text{C}$		135	W
I_{FSM}	max. forward surge current	$t = 10$ ms; (50 Hz), sine	$T_{VJ} = 45^\circ\text{C}$			350	A
		$t = 8,3$ ms; (60 Hz), sine	$V_R = 0$ V			380	A
		$t = 10$ ms; (50 Hz), sine	$T_{VJ} = 150^\circ\text{C}$			300	A
		$t = 8,3$ ms; (60 Hz), sine	$V_R = 0$ V			320	A
I^2t	value for fusing	$t = 10$ ms; (50 Hz), sine	$T_{VJ} = 45^\circ\text{C}$			615	A ² s
		$t = 8,3$ ms; (60 Hz), sine	$V_R = 0$ V			600	A ² s
		$t = 10$ ms; (50 Hz), sine	$T_{VJ} = 150^\circ\text{C}$			450	A ² s
		$t = 8,3$ ms; (60 Hz), sine	$V_R = 0$ V			425	A ² s
C_J	junction capacitance	$V_R = 400$ V; $f = 1$ MHz		$T_{VJ} = 25^\circ\text{C}$		11	pF



Package SMPD		Ratings				
Symbol	Definition	Conditions	min.	typ.	max.	Unit
I_{RMS}	RMS current	per terminal			100	A
T_{VJ}	virtual junction temperature		-55		175	°C
T_{op}	operation temperature		-55		150	°C
T_{stg}	storage temperature		-55		150	°C
Weight				8.5		g
F_C	mounting force with clip		40		130	N
$d_{Spp/ App}$	creepage distance on surface / striking distance through air	terminal to terminal	1.6			mm
$d_{Spb/ Apb}$		terminal to backside	4.0			mm
V_{ISOL}	isolation voltage	t = 1 second	3000			V
		t = 1 minute	2500			V

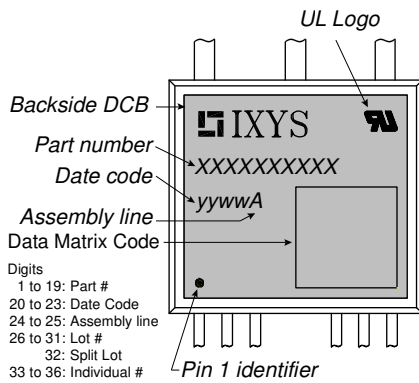

Part description

- D = Diode
- M = Standard Rectifier
- A = (up to 1800V)
- 90 = Current Rating [A]
- U = 3- Rectifier Bridge
- 1800 = Reverse Voltage [V]
- LB = SMPD-B

Ordering	Ordering Number	Marking on Product	Delivery Mode	Quantity	Code No.
Standard	DMA90U1800LB-TUB	DMA90U1800LB	Tube	20	517130
Alternative	DMA90U1800LB-TRR	DMA90U1800LB	Tape & Reel	200	524497

Equivalent Circuits for Simulation

* on die level

$T_{VJ} = 175\text{ °C}$

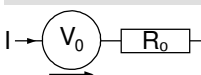

Rectifier

$V_{0\ max}$	threshold voltage	0.81	V
$R_{0\ max}$	slope resistance *	10.1	mΩ



Outlines SMPD

A (8 : 1)

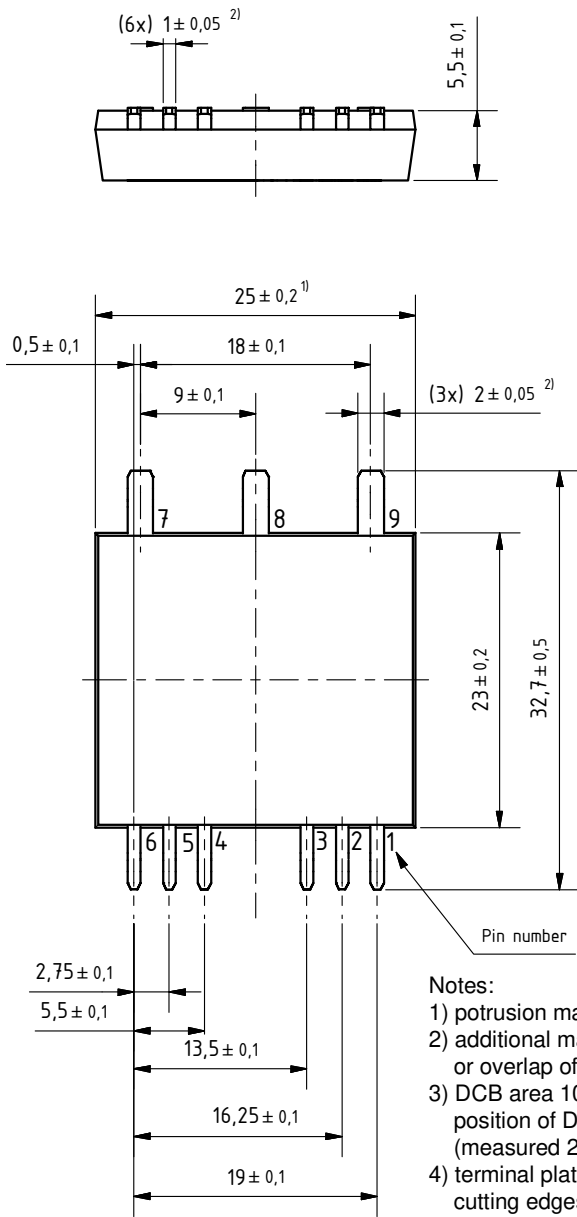

Notes:

- 1) protrusion may add 0.2 mm max. on each side
- 2) additional max. 0.05 mm per side by punching misalignment or overlap of dam bar or bending compression
- 3) DCB area 10 to 50 μm convex; position of DCB area in relation to plastic rim: $\pm 25 \mu\text{m}$ (measured 2 mm from Cu rim)
- 4) terminal plating: 0.2 - 1 μm Ni + 10 - 25 μm Sn (gal v.) cutting edges may be partially free of plating

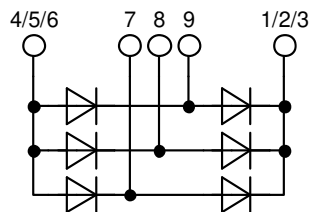



Rectifier

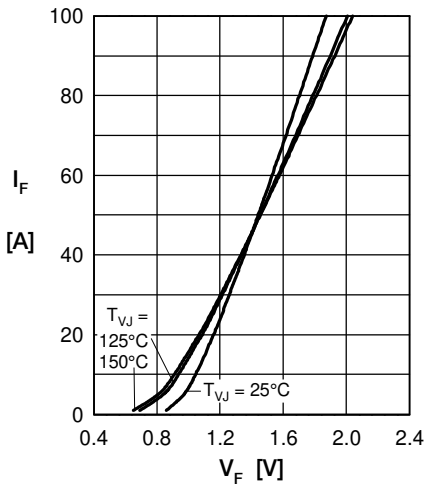

Fig. 1 Forward current vs. voltage drop per diode

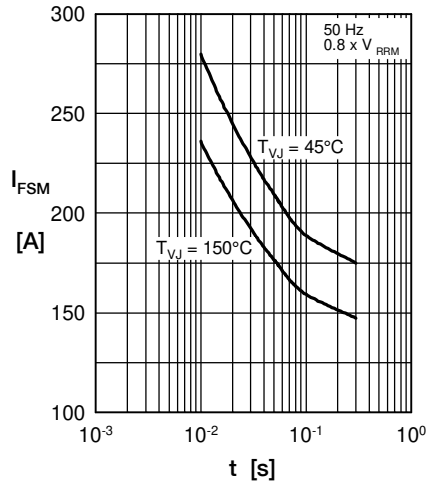

Fig. 2 Surge overload current vs. time per diode

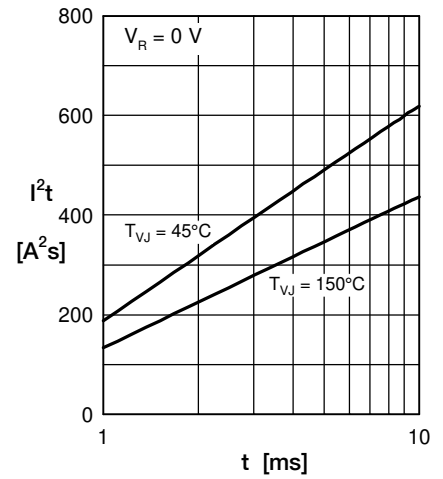

Fig. 3 I^2t vs. time per diode

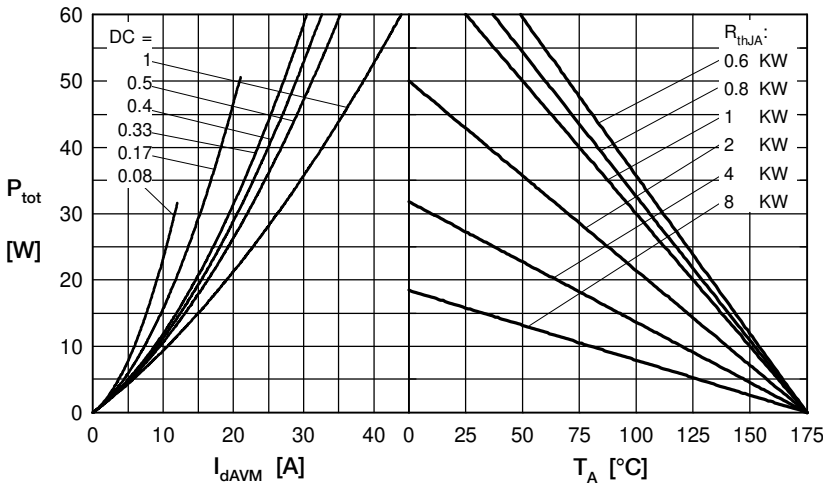

Fig. 4 Power dissipation vs. forward current and ambient temperature per diode

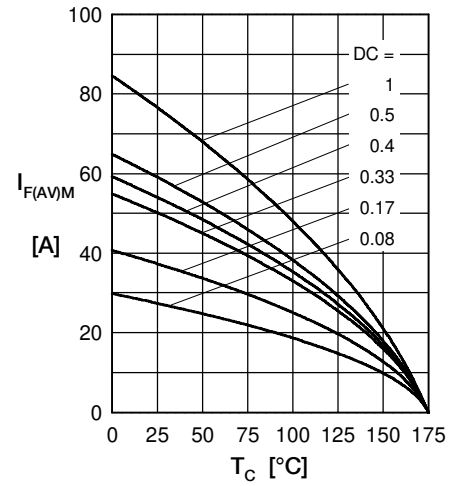

Fig. 5 Max. forward current vs. case temperature per diode

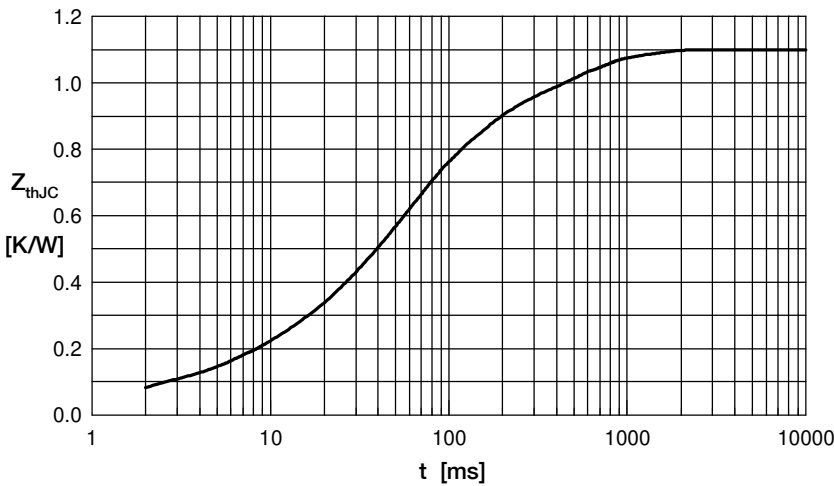

Fig. 6 Transient thermal impedance junction to case vs. time per diode

Constants for Z_{thJC} calculation:

i	R_{th} (K/W)	t_i (s)
1	0.030	0.0003
2	0.072	0.0045
3	0.092	0.0530
4	0.606	0.0520
5	0.300	0.4000