



Standard Rectifier

$$V_{RRM} = 1600\text{ V}$$

$$I_{FAV} = 10\text{ A}$$

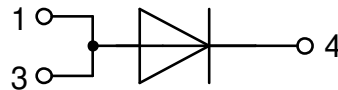
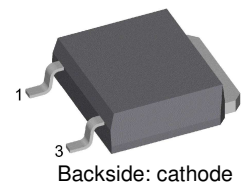
$$V_F = 1.21\text{ V}$$

Single Diode

Part number

DMA10IM1600UZ

Marking on Product: MAUMZI



Features / Advantages:

- Planar passivated chips
- Very low leakage current
- Very low forward voltage drop
- Improved thermal behaviour
- High commutation robustness
- High surge capability

Applications:

- Diode for main rectification
- For single and three phase bridge configurations

Package: TO-252 (DPak)

- Industry standard outline
- RoHS compliant
- Epoxy meets UL 94V-0
- High creepage distance between terminals

Disclaimer Notice

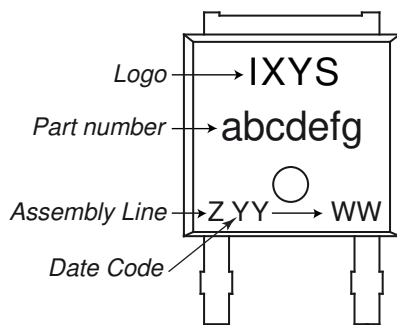
Information furnished is believed to be accurate and reliable. However, users should independently evaluate the suitability of and test each product selected for their own applications. Littelfuse products are not designed for, and may not be used in, all applications. Read complete Disclaimer Notice at www.littelfuse.com/disclaimer-electronics.

Rectifier				Ratings			
Symbol	Definition	Conditions		min.	typ.	max.	Unit
V_{RSM}	max. non-repetitive reverse blocking voltage					1700	V
V_{RRM}	max. repetitive reverse blocking voltage					1600	V
I_R	reverse current	$V_R = 1600$ V		$T_{VJ} = 25^\circ\text{C}$		10	μA
		$V_R = 1600$ V		$T_{VJ} = 150^\circ\text{C}$		0.2	mA
V_F	forward voltage drop	$I_F = 10$ A		$T_{VJ} = 25^\circ\text{C}$		1.26	V
		$I_F = 20$ A				1.53	V
		$I_F = 10$ A		$T_{VJ} = 150^\circ\text{C}$		1.21	V
		$I_F = 20$ A				1.57	V
I_{FAV}	average forward current	$T_C = 150^\circ\text{C}$	rectangular	$T_{VJ} = 175^\circ\text{C}$		10	A
V_{FO}	threshold voltage	} for power loss calculation only		$T_{VJ} = 175^\circ\text{C}$		0.82	V
r_F	slope resistance					37	m Ω
R_{thJC}	thermal resistance junction to case					1.5	K/W
R_{thCH}	thermal resistance case to heatsink				0.50		K/W
P_{tot}	total power dissipation			$T_C = 25^\circ\text{C}$		100	W
I_{FSM}	max. forward surge current	$t = 10$ ms; (50 Hz), sine		$T_{VJ} = 45^\circ\text{C}$		120	A
		$t = 8,3$ ms; (60 Hz), sine		$V_R = 0$ V		130	A
		$t = 10$ ms; (50 Hz), sine		$T_{VJ} = 150^\circ\text{C}$		100	A
		$t = 8,3$ ms; (60 Hz), sine		$V_R = 0$ V		110	A
I^2t	value for fusing	$t = 10$ ms; (50 Hz), sine		$T_{VJ} = 45^\circ\text{C}$		72	A ² s
		$t = 8,3$ ms; (60 Hz), sine		$V_R = 0$ V		70	A ² s
		$t = 10$ ms; (50 Hz), sine		$T_{VJ} = 150^\circ\text{C}$		50	A ² s
		$t = 8,3$ ms; (60 Hz), sine		$V_R = 0$ V		50	A ² s
C_J	junction capacitance	$V_R = 400$ V; $f = 1$ MHz		$T_{VJ} = 25^\circ\text{C}$		4	pF



Package TO-252 (DPak)			Ratings			
Symbol	Definition	Conditions	min.	typ.	max.	Unit
I_{RMS}	RMS current	per terminal			20	A
T_{VJ}	virtual junction temperature		-55		175	°C
T_{op}	operation temperature		-55		150	°C
T_{stg}	storage temperature		-55		150	°C
Weight				0.3		g
F_C	mounting force with clip		20		60	N
$d_{Spp/App}$	creepage distance on surface / striking distance through air	terminal to terminal	3.6			mm
$d_{Spb/Apb}$		terminal to backside	3.0			mm

Product Marking



Part description

- D = Diode
- M = Standard Rectifier
- A = (up to 1800V)
- 10 = Current Rating [A]
- IM = Single Diode
- 1600 = Reverse Voltage [V]
- UZ = TO-252AA (DPak) (2HV)

Ordering	Ordering Number	Marking on Product	Delivery Mode	Quantity	Code No.
Standard	DMA10IM1600UZ-TRL	MAUMZI	Tape & Reel	2500	523222
Alternative	DMA10IM1600UZ-TUB	MAUMZI	Tube	70	523581

Similar Part	Package	Voltage class
DMA10IM1200UZ	TO-252AA (DPak) (2HV)	1200

Equivalent Circuits for Simulation

* on die level

$T_{VJ} = 175\text{°C}$

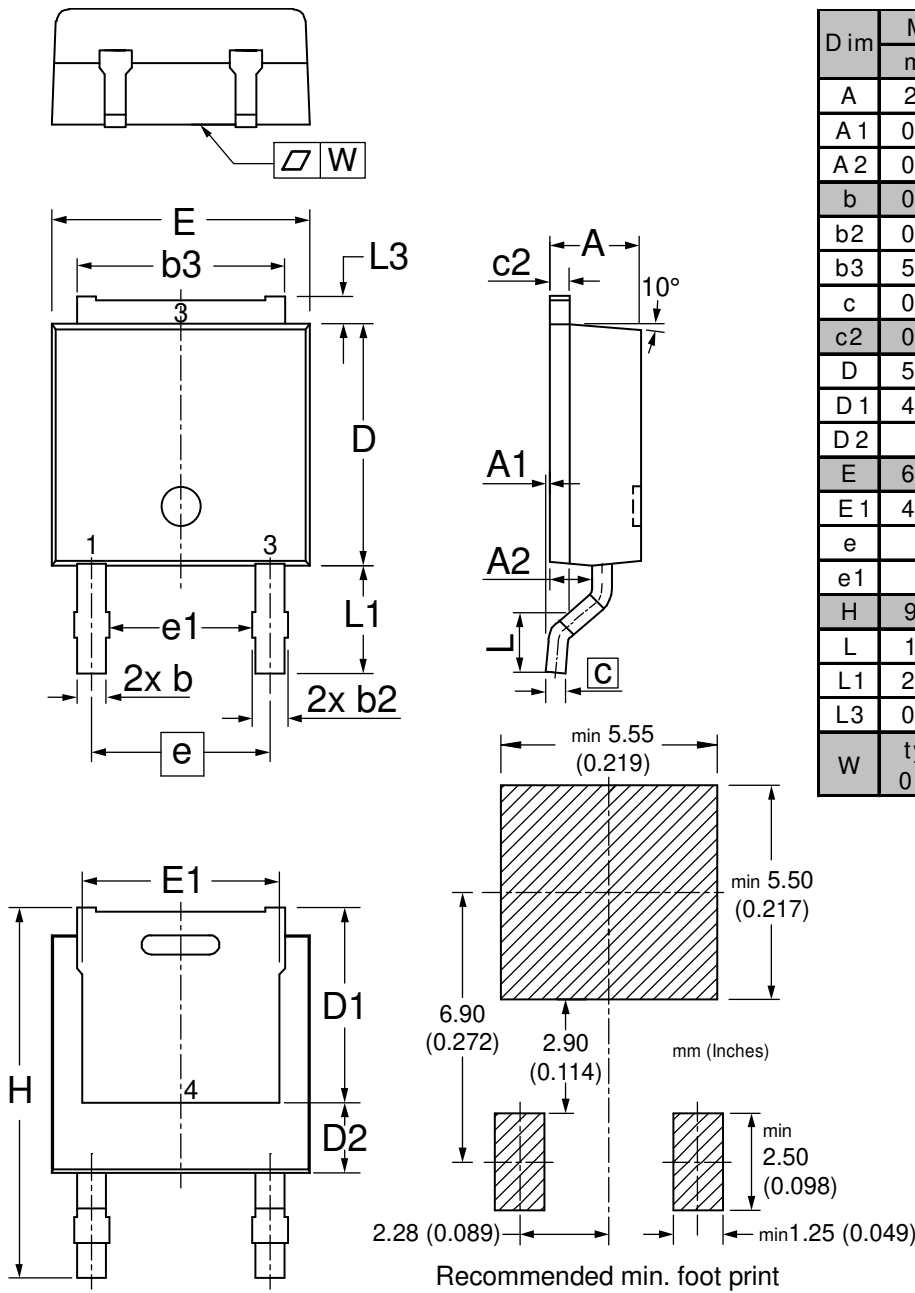


Rectifier

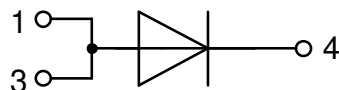
$V_{0\ max}$	threshold voltage	0.82	V
$R_{0\ max}$	slope resistance *	34	mΩ



Outlines TO-252 (DPak)



Dim	Millimeters		Inches	
	min	max	min	max
A	2.18	2.39	0.086	0.094
A1	0.00	0.13	0.000	0.005
A2	0.97	1.17	0.038	0.046
b	0.64	0.89	0.025	0.035
b2	0.76	1.14	0.030	0.045
b3	5.08	5.59	0.200	0.220
c	0.46	0.61	0.018	0.024
c2	0.46	0.58	0.018	0.023
D	5.97	6.22	0.235	0.245
D1	4.57	5.21	0.180	0.205
D2	2.03		0.080	
E	6.35	6.73	0.250	0.265
E1	4.32	5.21	0.170	0.205
e	4.57		0.180	
e1	3.62		0.143	
H	9.15	10.34	0.360	0.407
L	1.40	1.78	0.055	0.070
L1	2.54	2.92	0.100	0.115
L3	0.64	1.02	0.025	0.040
W	typ. 0.02	0.040	typ. 0.0008	0.000



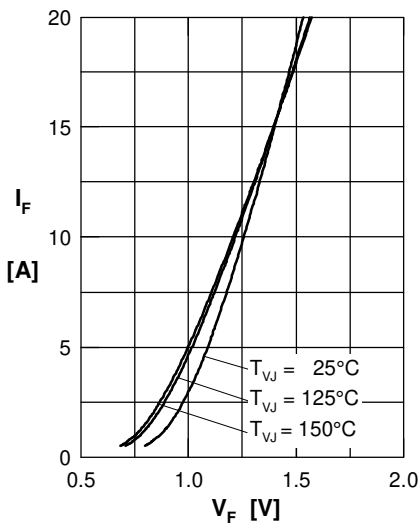
Rectifier


Fig. 1 Forward current versus voltage drop per diode

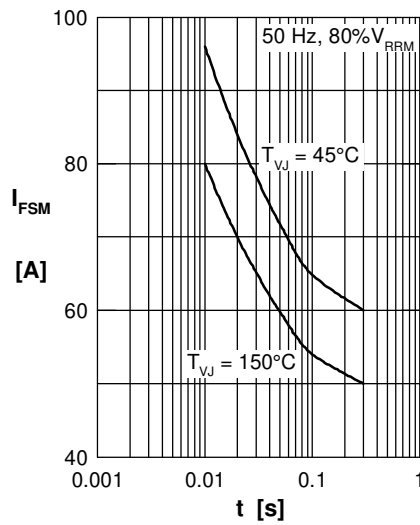


Fig. 2 Surge overload current

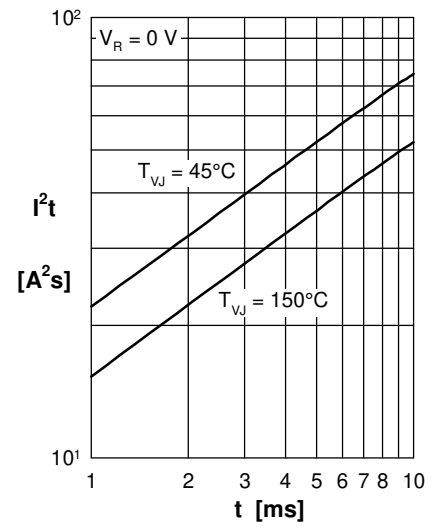
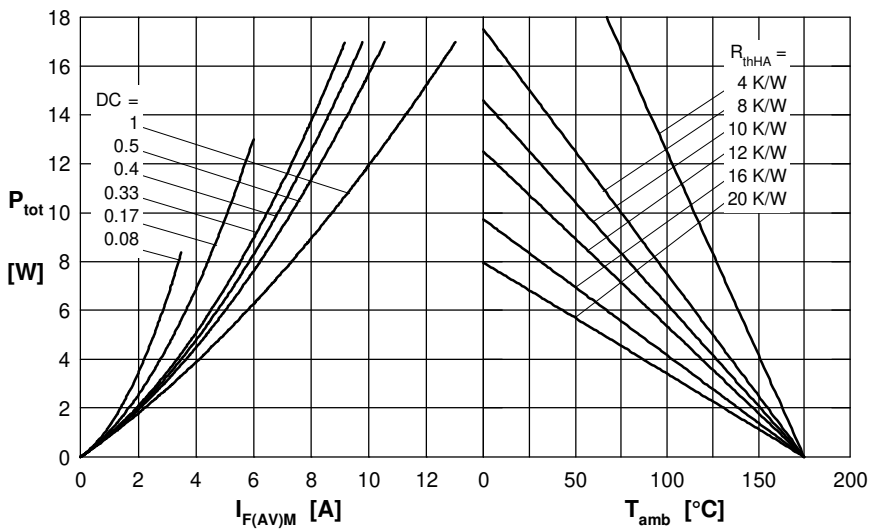

 Fig. 3 I^2t versus time per diode


Fig. 4 Power dissipation vs. direct output current and ambient temperature

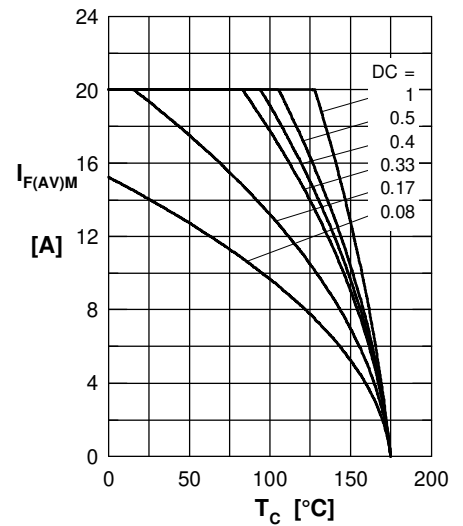


Fig. 5 Max. forward current vs. case temperature

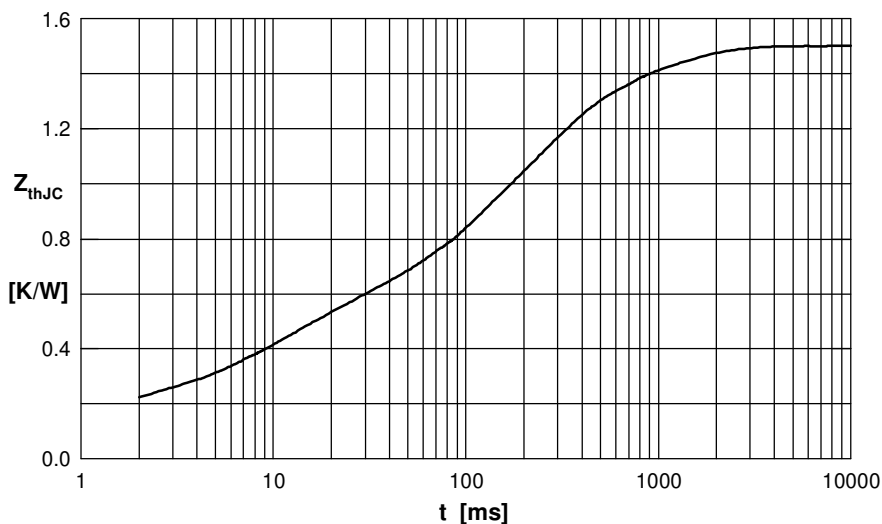


Fig. 6 Transient thermal impedance junction to case

 Constants for Z_{thJC} calculation:

i	R_{thi} (K/W)	t_i (s)
1	0.155	0.0005
2	0.332	0.0095
3	0.713	0.17
4	0.3	0.8