

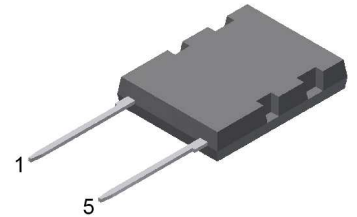
Sonic Fast Recovery Diode

V_{RRM}	=	4500 V
I_{F80}	=	43 A
t_{rr}	=	1450 ns

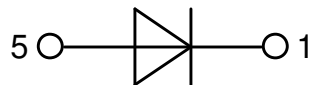
High Performance Fast Recovery Diode
 Low Loss and Soft Recovery
 Single Diode

Part number

DHG40I4500KO



Backside: isolated
 see important note page 4



Features / Advantages:

- Planar passivated chips
- Very low leakage current
- Very short recovery time
- Improved thermal behaviour
- Very low I_{rm} -values
- Very soft recovery behaviour
- Avalanche voltage rated for reliable operation
- Soft reverse recovery for low EMI/RFI
- Low I_{rm} reduces:
 - Power dissipation within the diode
 - Turn-on loss in the commutating switch

Applications:

- Antiparallel diode for high frequency switching devices
- Snubber diode
- Free wheeling diode
- Rectifiers in switch mode power supplies (SMPS)
- Uninterruptible power supplies (UPS)

Package: ISOPLUS264

- Isolation Voltage: 4200 V~
- Industry convenient outline
- RoHS compliant
- Epoxy meets UL 94V-0
- Soldering pins for PCB mounting
- Backside: DCB ceramic
- Reduced weight
- Advanced power cycling

Disclaimer Notice

Information furnished is believed to be accurate and reliable. However, users should independently evaluate the suitability of and test each product selected for their own applications. Littelfuse products are not designed for, and may not be used in, all applications. Read complete Disclaimer Notice at www.littelfuse.com/disclaimer-electronics.

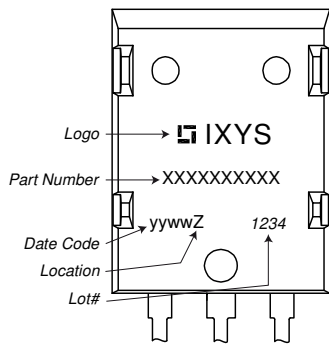


Fast Diode				Ratings			
Symbol	Definition	Conditions		min.	typ.	max.	Unit
V_{RSM}	max. non-repetitive reverse blocking voltage					4500	V
V_{RRM}	max. repetitive reverse blocking voltage					4500	V
I_R	reverse current, drain current	$V_R = 4500\text{ V}$		$T_{VJ} = 25^\circ\text{C}$		100	μA
		$V_R = 4500\text{ V}$		$T_{VJ} = 125^\circ\text{C}$		2	mA
V_F	forward voltage drop	$I_F = 50\text{ A}$		$T_{VJ} = 25^\circ\text{C}$		3.02	V
		$I_F = 100\text{ A}$				3.67	V
		$I_F = 50\text{ A}$		$T_{VJ} = 125^\circ\text{C}$		3.33	V
		$I_F = 100\text{ A}$				4.35	V
I_{FAV}	average forward current	$T_C = 80^\circ\text{C}$	rectangular	$T_{VJ} = 150^\circ\text{C}$		43	A
V_{FO}	threshold voltage	} for power loss calculation only		$T_{VJ} = 150^\circ\text{C}$		2.20	V
r_F	slope resistance					24	m Ω
R_{thJC}	thermal resistance junction to case					0.5	K/W
R_{thCH}	thermal resistance case to heatsink				0.15		K/W
P_{tot}	total power dissipation			$T_C = 25^\circ\text{C}$		250	W
I_{FSM}	max. forward surge current	$t = 10\text{ ms}; (50\text{ Hz}), \text{ sine}; V_R = 0\text{ V}$		$T_{VJ} = 45^\circ\text{C}$		600	A
C_J	junction capacitance	$V_R = 1800\text{ V}$ $f = 1\text{ MHz}$		$T_{VJ} = 25^\circ\text{C}$		13	pF
I_{RM}	max. reverse recovery current	} $I_F = 50\text{ A}; V_R = 2800\text{ V}$		$T_{VJ} = 25^\circ\text{C}$		80	A
				$T_{VJ} = 125^\circ\text{C}$		82	A
t_{rr}	reverse recovery time	} $-di_F/dt = 800\text{ A}/\mu\text{s}$		$T_{VJ} = 25^\circ\text{C}$		1450	ns
				$T_{VJ} = 125^\circ\text{C}$		2200	ns



Package ISOPLUS264		Ratings				
Symbol	Definition	Conditions	min.	typ.	max.	Unit
I_{RMS}	RMS current	per terminal			70	A
T_{VJ}	virtual junction temperature		-40		150	°C
T_{op}	operation temperature		-40		125	°C
T_{stg}	storage temperature		-40		150	°C
Weight				10		g
F_C	mounting force with clip		20		120	N
$d_{Spp/App}$	creepage distance on surface striking distance through air	terminal to terminal	13.8			mm
$d_{Spb/Apb}$		terminal to backside	5.0			mm
V_{ISOL}	isolation voltage	t = 1 second t = 1 minute	4200 3000			V V
		50/60 Hz, RMS; $I_{ISOL} \leq 1$ mA				

Product Marking



Part description

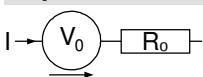
- D = Diode
- H = Sonic Fast Recovery Diode
- G = extreme fast
- 40 = Current Rating [A]
- I = Single Diode
- 4500 = Reverse Voltage [V]
- KO = ISOPLUS264 (2HV)

Ordering	Ordering Number	Marking on Product	Delivery Mode	Quantity	Code No.
Standard	DHG40I4500KO	DHG40I4500KO	Tube	25	520601

Equivalent Circuits for Simulation

* on die level

$T_{VJ} = 150^{\circ}C$

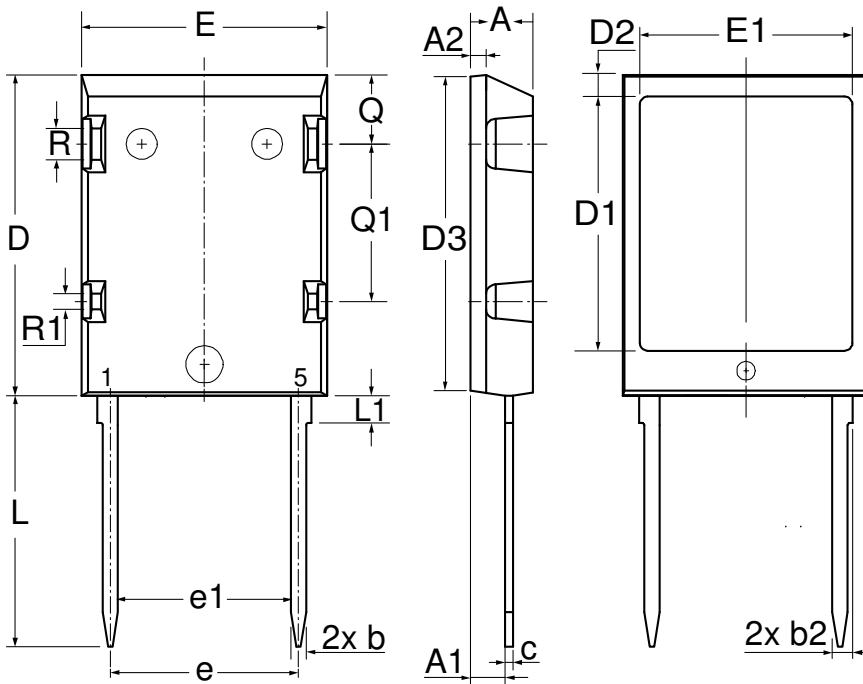


Fast Diode

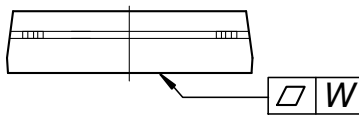
$V_{0\ max}$	threshold voltage	2.2	V
$R_{0\ max}$	slope resistance *	24	mΩ



Outlines ISOPLUS264



Dim.	Millimeter		Inches	
	min	max	min	max
A	4.83	5.21	0.190	0.205
A1	2.59	3.00	0.102	0.118
A2	1.17	1.40	0.046	0.055
b	1.14	1.40	0.045	0.055
b2	1.60	1.83	0.063	0.072
c	0.51	0.74	0.020	0.029
D	25.91	26.42	1.020	1.040
D1	20.34	20.85	0.801	0.821
D2	1.65	2.03	0.065	0.080
D3	25.29	25.78	1.000	1.020
E	19.56	20.29	0.770	0.799
E1	16.97	17.53	0.668	0.690
e	15.24	BSC	0.600	BSC
e1	14.10	BSC	0.555	BSC
L	19.81	20.83	0.780	0.820
L1	2.03	2.59	0.080	0.102
Q	5.33	5.97	0.210	0.235
Q1	12.45	13.03	0.490	0.513
R	3.81	4.57	0.150	0.180
R1	2.54	3.30	0.100	0.130
W	-	0.10	-	0.004

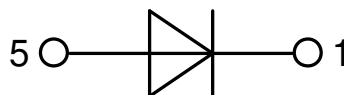


Die konvexe Form des Substrates ist typ. < 0.05 mm über der Kunststoffoberfläche der Bauteilunterseite
The convexbow of substrate is typ. < 0.05 mm over plastic surface level of device bottom side

Important note:

External clearances between pins and between pins and tab may be insufficient to prevent flash over under all conditions. It is the customer's responsibility to apply additional insulation appropriate to the application. ISOPLUS264 is designed to isolate a max continuous operation voltage (DC) of 1700 V. The peak test voltage of 4200 V assures safety for transient voltages only. The package is not tested for partial discharge. If the product is used outside the package design voltage range the customer must use additional electrical insulation. Extra insulation layers should be used both between the tab and any heatsink and between any conducting clip and the top surface of the package particularly when metal parts (such as a heatsink or a clip) are in contact. Please note that the intention of this package is to provide customers with an encapsulated die for high voltage application but the responsibility rests entirely with the customer to ensure for safe operation. Bodily injury cannot be excluded if this warning is disregarded. Device implementation is the end user's responsibility.

For a low FIT rate over lifetime failures due to SEB (Single Event Burnout) and an adequate voltage derating should be considered.



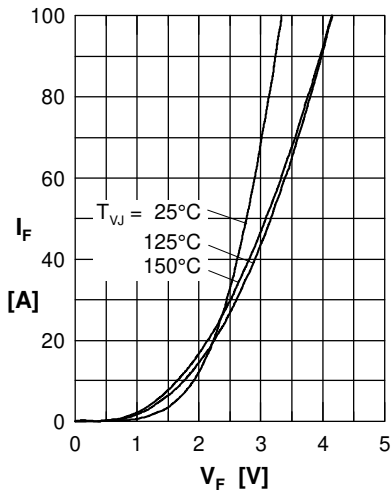
Fast Diode


Fig. 1 Forward current I_F versus V_F

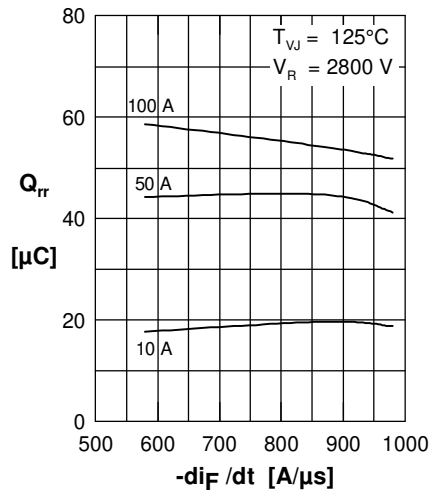


Fig. 2 Typ. reverse recov. charge Q_{rr} versus $-di_F/dt$

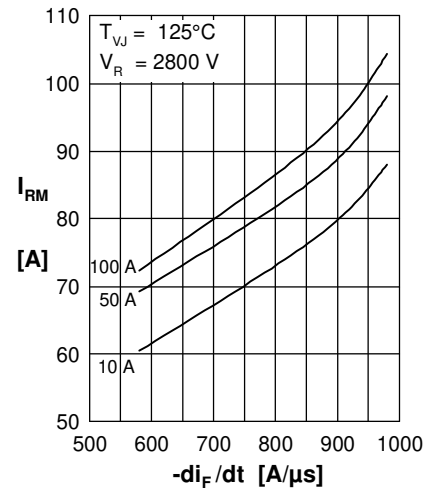


Fig. 3 Typ. reverse recov. current I_{RM} versus $-di_F/dt$

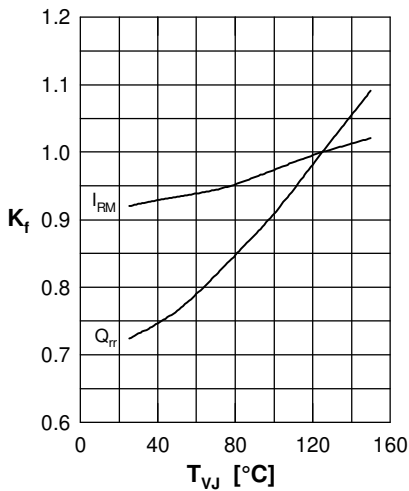


Fig. 4 Typ. dynamic parameters Q_{rr} , I_{RM} versus T_{VJ}

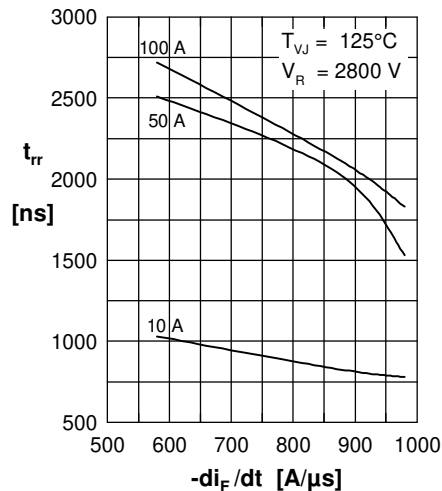


Fig. 5 Typ. reverse recov. time t_{rr} versus $-di_F/dt$

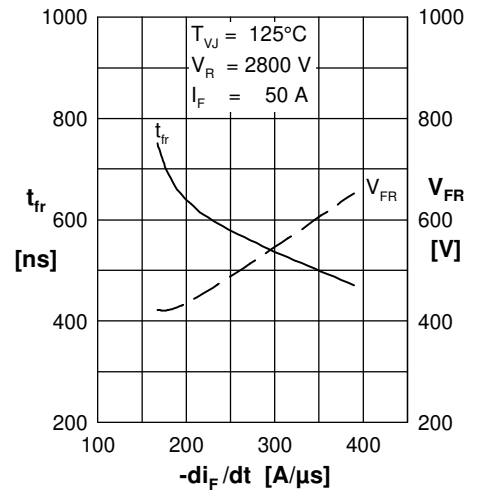


Fig. 6 Typ. forward recov. voltage V_{FR} & time t_{fr} versus di_F/dt

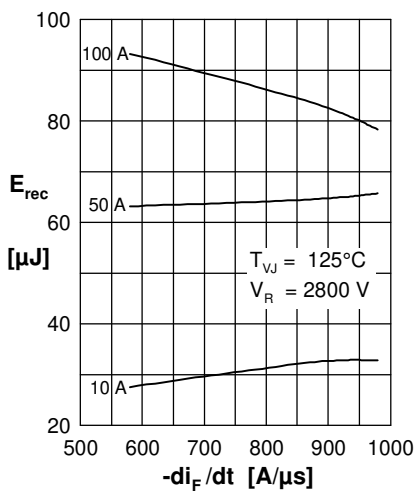


Fig. 7 Typ. recovery energy E_{rec} versus $-di_F/dt$

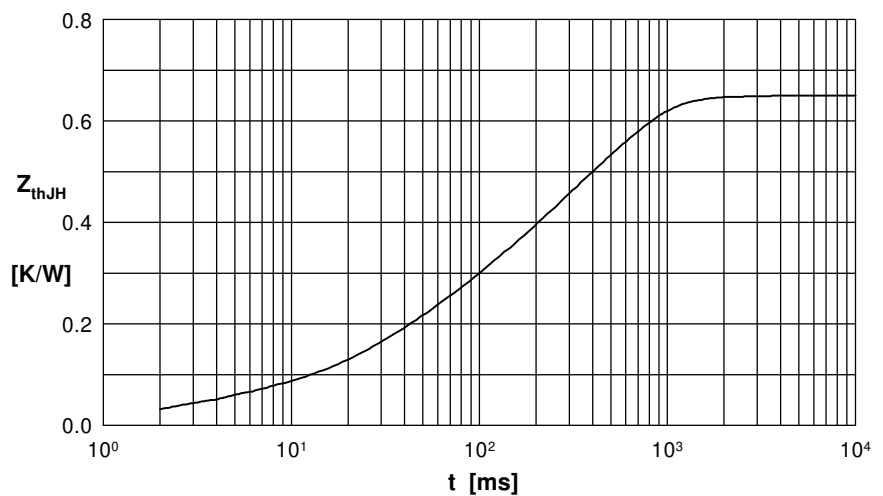


Fig. 8 Typical transient thermal impedance junction to heatsink