

# Sonic Fast Recovery Diode

$V_{RRM} = 1800\text{ V}$   
 $I_{FAV} = 10\text{ A}$   
 $t_{rr} = 260\text{ ns}$

High Performance Fast Recovery Diode  
 Low Loss and Soft Recovery  
 Single Diode

**Part number**

**DHG10IM1800UZ**

Marking on Product: HAVGZI

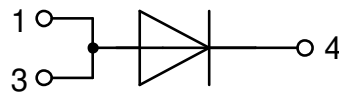
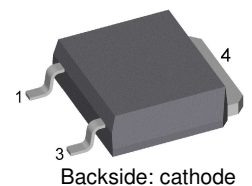

## Features / Advantages:

- Planar passivated chips
- Very low leakage current
- Very short recovery time
- Improved thermal behaviour
- Very low  $I_{rm}$ -values
- Very soft recovery behaviour
- Avalanche voltage rated for reliable operation
- Soft reverse recovery for low EMI/RFI
- Low  $I_{rm}$  reduces:
  - Power dissipation within the diode
  - Turn-on loss in the commutating switch

## Applications:

- Antiparallel diode for high frequency switching devices
- Antisaturation diode
- Snubber diode
- Free wheeling diode
- Rectifiers in switch mode power supplies (SMPS)
- Uninterruptible power supplies (UPS)

## Package: TO-252 (DPak)

- Industry standard outline
- RoHS compliant
- Epoxy meets UL 94V-0

## Disclaimer Notice

Information furnished is believed to be accurate and reliable. However, users should independently evaluate the suitability of and test each product selected for their own applications. Littelfuse products are not designed for, and may not be used in, all applications. Read complete Disclaimer Notice at [www.littelfuse.com/disclaimer-electronics](http://www.littelfuse.com/disclaimer-electronics).



Fast Diode				Ratings			
Symbol	Definition	Conditions	min.	typ.	max.	Unit	
$V_{RSM}$	max. non-repetitive reverse blocking voltage	$T_{VJ} = 25^{\circ}C$			1800	V	
$V_{RRM}$	max. repetitive reverse blocking voltage	$T_{VJ} = 25^{\circ}C$			1800	V	
$I_R$	reverse current, drain current	$V_R = 1800 V$	$T_{VJ} = 25^{\circ}C$		50	$\mu A$	
		$V_R = 1800 V$	$T_{VJ} = 150^{\circ}C$		0.4	mA	
$V_F$	forward voltage drop	$I_F = 10 A$	$T_{VJ} = 25^{\circ}C$		2.27	V	
		$I_F = 20 A$			2.94	V	
		$I_F = 10 A$	$T_{VJ} = 150^{\circ}C$		2.43	V	
		$I_F = 20 A$			3.42	V	
$I_{FAV}$	average forward current	$T_C = 110^{\circ}C$ rectangular $d = 0.5$	$T_{VJ} = 175^{\circ}C$		10	A	
$V_{FO}$	threshold voltage	} for power loss calculation only	$T_{VJ} = 175^{\circ}C$		1.40	V	
$r_F$	slope resistance				101	m $\Omega$	
$R_{thJC}$	thermal resistance junction to case				1.5	K/W	
$R_{thCH}$	thermal resistance case to heatsink			0.5		K/W	
$P_{tot}$	total power dissipation		$T_C = 25^{\circ}C$		85	W	
$I_{FSM}$	max. forward surge current	$t = 10 ms; (50 Hz), sine; V_R = 0 V$	$T_{VJ} = 45^{\circ}C$		60	A	
$C_J$	junction capacitance	$V_R = 200 V \quad f = 1 MHz$	$T_{VJ} = 25^{\circ}C$		3	pF	
$I_{RM}$	max. reverse recovery current	} $I_F = 10 A; V_R = 900 V$ $-di_F / dt = 350 A/\mu s$	$T_{VJ} = 25^{\circ}C$		15	A	
			$T_{VJ} = 150^{\circ}C$		17.5	A	
$t_{rr}$	reverse recovery time		$T_{VJ} = 25^{\circ}C$		260	ns	
			$T_{VJ} = 150^{\circ}C$		350	ns	



Package TO-252 (DPak)		Ratings				
Symbol	Definition	Conditions	min.	typ.	max.	Unit
$I_{RMS}$	RMS current	per terminal			20	A
$T_{VJ}$	virtual junction temperature		-55		175	°C
$T_{op}$	operation temperature		-55		150	°C
$T_{stg}$	storage temperature		-55		150	°C
<b>Weight</b>				0.3		g
$F_C$	mounting force with clip		20		60	N
$d_{Spp/App}$	creepage distance on surface / striking distance through air	terminal to terminal	3.6			mm
$d_{Spb/Apb}$		terminal to backside	3.0			mm

**Product Marking**

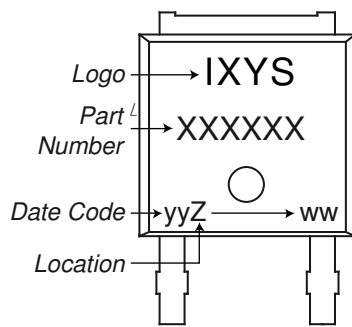

**Part description**

- D = Diode
- H = Sonic Fast Recovery Diode
- G = extreme fast
- 10 = Current Rating [A]
- IM = Single Diode
- 1800 = Reverse Voltage [V]
- UZ = TO-252AA (DPak) (2HV)

Ordering	Ordering Number	Marking on Product	Delivery Mode	Quantity	Code No.
Standard	DHG10IM1800UZ-TRL	HAVGZI	Tape & Reel	2500	526360
Alternative	DHG10IM1800UZ-TUB	HAVGZI	Tube	70	526353

Similar Part	Package	Voltage class
DHG10I1800PA	TO-220AC (2)	1800

**Equivalent Circuits for Simulation**

\* on die level

$T_{VJ} = 175^{\circ}C$

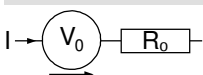

**Fast Diode**

$V_{0\ max}$	threshold voltage	1.4	V
$R_{0\ max}$	slope resistance *	98	mΩ



**Outlines TO-252 (DPak)**

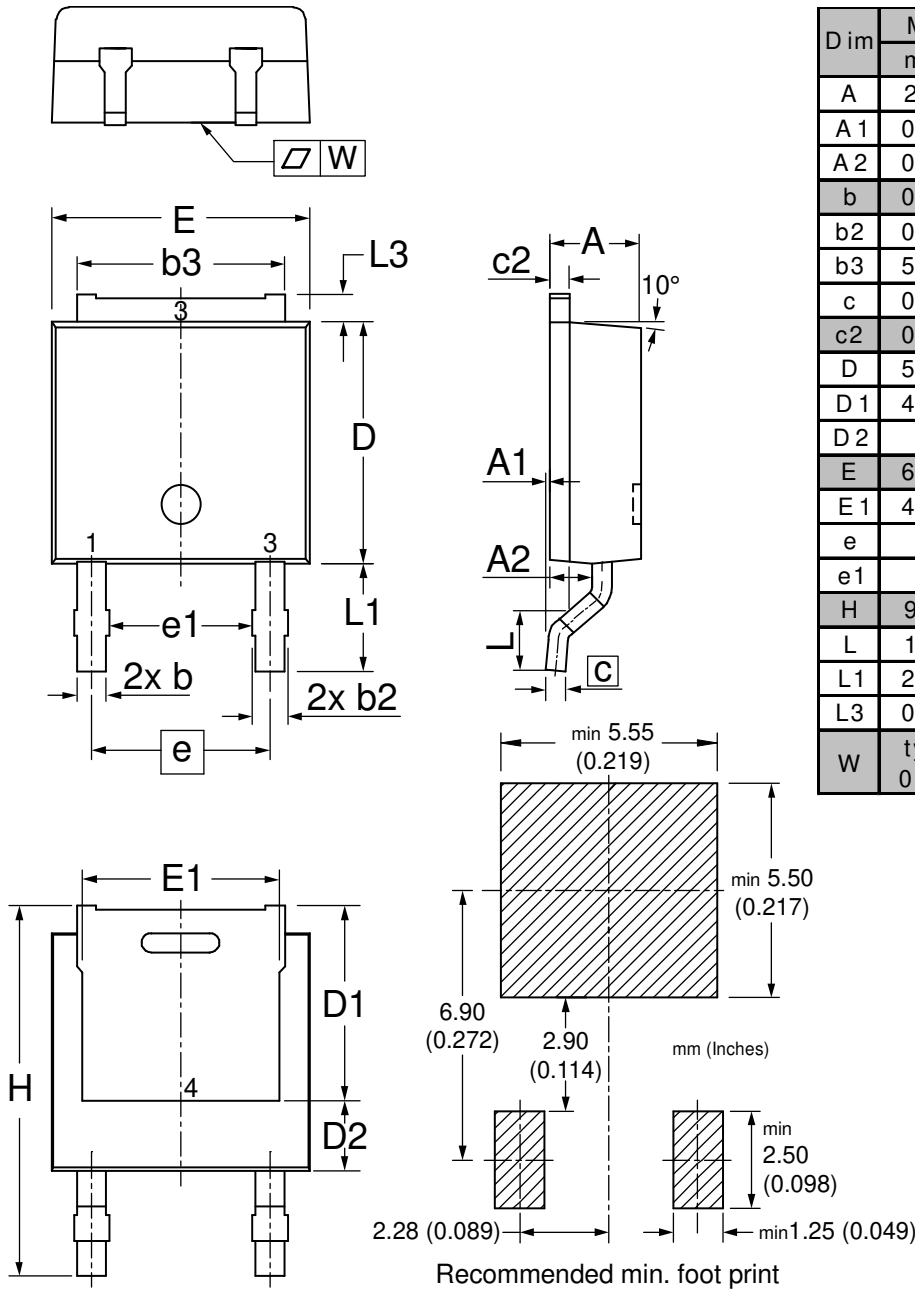

Dim	Millimeters		Inches	
	min	max	min	max
A	2.18	2.39	0.086	0.094
A1	0.00	0.13	0.000	0.005
A2	0.97	1.17	0.038	0.046
b	0.64	0.89	0.025	0.035
b2	0.76	1.14	0.030	0.045
b3	5.08	5.59	0.200	0.220
c	0.46	0.61	0.018	0.024
c2	0.46	0.58	0.018	0.023
D	5.97	6.22	0.235	0.245
D1	4.57	5.21	0.180	0.205
D2	2.03		0.080	
E	6.35	6.73	0.250	0.265
E1	4.32	5.21	0.170	0.205
e	4.57		0.180	
e1	3.62		0.143	
H	9.15	10.34	0.360	0.407
L	1.40	1.78	0.055	0.070
L1	2.54	2.92	0.100	0.115
L3	0.64	1.02	0.025	0.040
W	typ. 0.02	0.040	typ. 0.0008	0.000

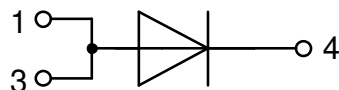



**Fast Diode**

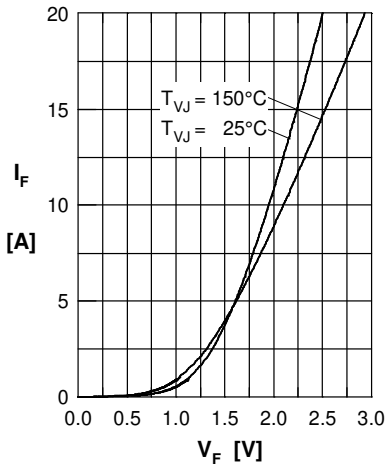

Fig. 1 Typ. Forward current versus  $V_F$

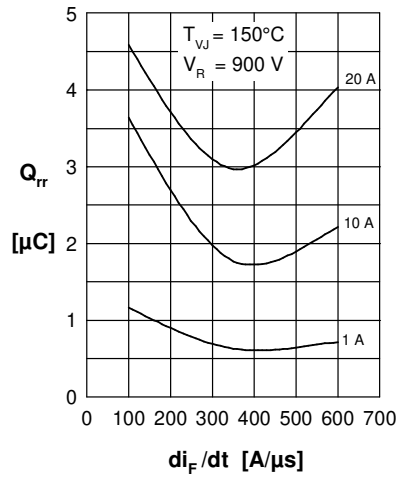

Fig. 2 Typ. reverse recov. charge  $Q_{rr}$  versus  $di/dt$

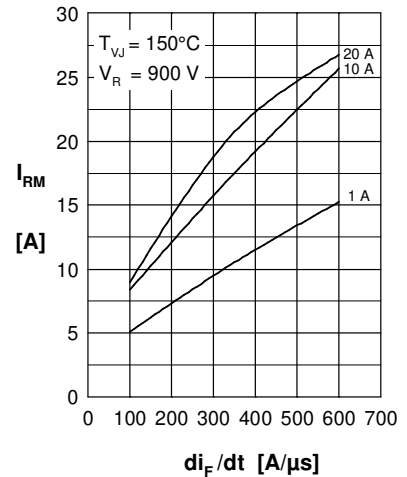

Fig. 3 Typ. peak reverse current  $I_{RM}$  versus  $di/dt$

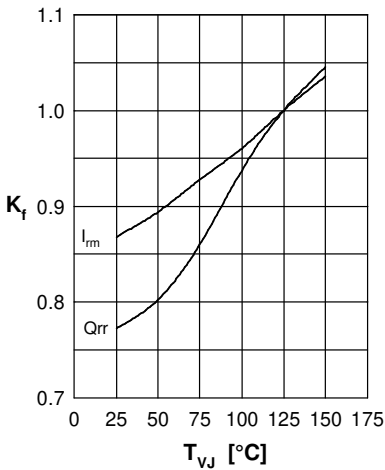

Fig. 4 Dynamic parameters  $Q_{rr}$ ,  $I_{RM}$  versus  $T_{VJ}$

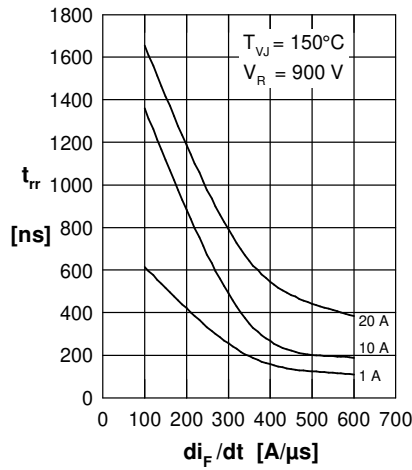

Fig. 5 Typ. recovery time  $t_{rr}$  versus  $di_F/dt$

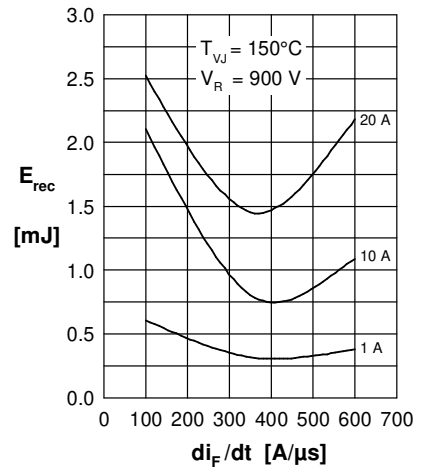

Fig. 6 Typ. recovery energy  $E_{rec}$  versus  $di/dt$

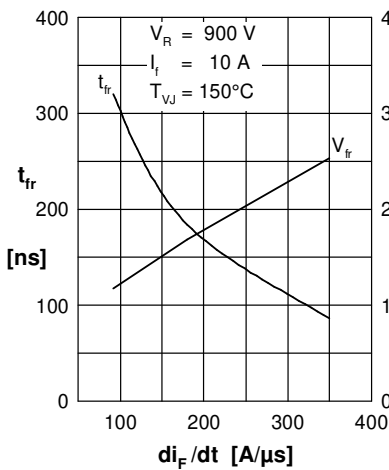

Fig. 7 Typ. peak forward voltage  $V_{fr}$  and  $t_{rr}$  versus  $di_F/dt$

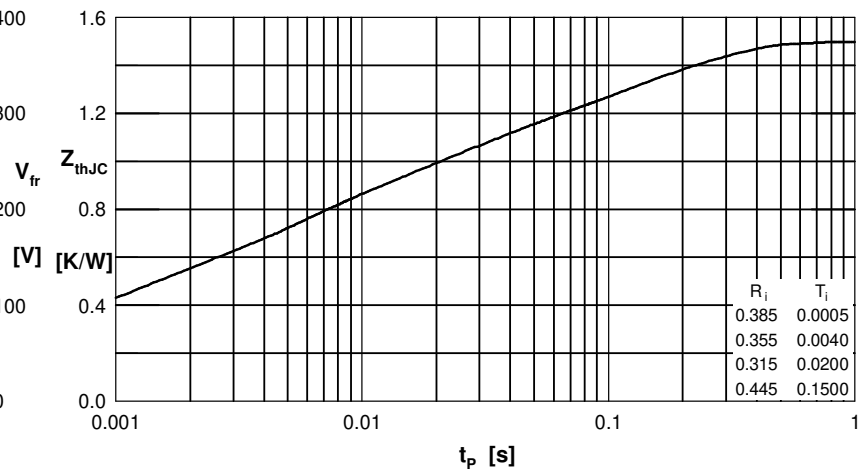

Fig. 8 Typ. transient thermal impedance junction to case