

Thyristor

$$V_{RRM} = 1600V$$

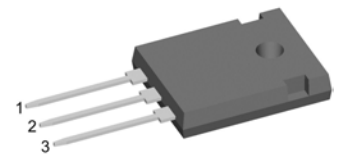
$$I_{TAV} = 30A$$

$$V_T = 1,35V$$

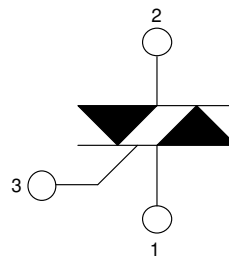
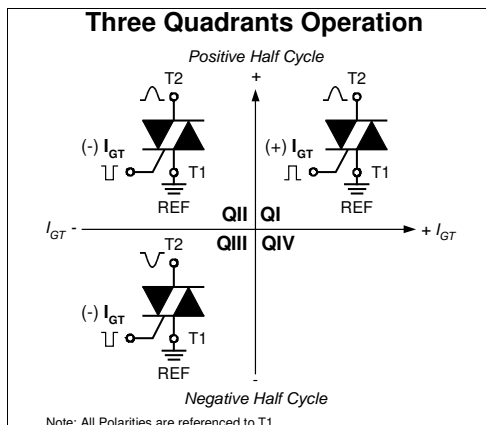
Three Quadrants operation: QI - QIII
 1~ Triac

Part number

CMA60MT1600NHB



Backside: Terminal 2



Features / Advantages:

- Triac for line frequency
- Three Quadrants Operation
 - QI - QIII
- Planar passivated chip
- Long-term stability of blocking currents and voltages

Applications:

- Line rectifying 50/60 Hz
- Softstart AC motor control
- DC Motor control
- Power converter
- AC power control
- Lighting and temperature control

Package: TO-247

- Industry standard outline
- RoHS compliant
- Epoxy meets UL 94V-0

Disclaimer Notice

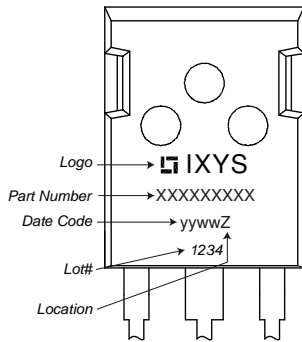
Information furnished is believed to be accurate and reliable. However, users should independently evaluate the suitability of and test each product selected for their own applications. Littelfuse products are not designed for, and may not be used in, all applications. Read complete Disclaimer Notice at www.littelfuse.com/disclaimer-electronics.

| Rectifier | | | | Ratings | | | |
|----------------|--|--|-------------------------|---------|----------|------------------|--|
| Symbol | Definition | Conditions | min. | typ. | max. | Unit | |
| $V_{RSM/DSM}$ | max. non-repetitive reverse/forward blocking voltage | $T_{VJ} = 25^{\circ}C$ | | | 1700 | V | |
| $V_{RRM/DRM}$ | max. repetitive reverse/forward blocking voltage | $T_{VJ} = 25^{\circ}C$ | | | 1600 | V | |
| I_{RD} | reverse current, drain current | $V_{R/D} = 1600 V$ | $T_{VJ} = 25^{\circ}C$ | | 10 | μA | |
| | | $V_{R/D} = 1600 V$ | $T_{VJ} = 125^{\circ}C$ | | 2 | mA | |
| V_T | forward voltage drop | $I_T = 30 A$ | $T_{VJ} = 25^{\circ}C$ | | 1,36 | V | |
| | | $I_T = 60 A$ | | | 1,70 | V | |
| | | $I_T = 30 A$ | $T_{VJ} = 125^{\circ}C$ | | 1,35 | V | |
| | | $I_T = 60 A$ | | | 1,79 | V | |
| I_{TAV} | average forward current | $T_C = 115^{\circ}C$ | $T_{VJ} = 150^{\circ}C$ | | 30 | A | |
| I_{RMS} | RMS forward current per phase | 180° sine | | | 66 | A | |
| V_{T0} | threshold voltage | } for power loss calculation only | $T_{VJ} = 150^{\circ}C$ | | 0,89 | V | |
| r_T | slope resistance | | | | 15,1 | m Ω | |
| R_{thJC} | thermal resistance junction to case | | | | 0,55 | K/W | |
| R_{thCH} | thermal resistance case to heatsink | | | 0,25 | | K/W | |
| P_{tot} | total power dissipation | | $T_C = 25^{\circ}C$ | | 230 | W | |
| I_{TSM} | max. forward surge current | $t = 10 \text{ ms}; (50 \text{ Hz}), \text{ sine}$ | $T_{VJ} = 45^{\circ}C$ | | 260 | A | |
| | | $t = 8,3 \text{ ms}; (60 \text{ Hz}), \text{ sine}$ | $V_R = 0 V$ | | 280 | A | |
| | | $t = 10 \text{ ms}; (50 \text{ Hz}), \text{ sine}$ | $T_{VJ} = 150^{\circ}C$ | | 220 | A | |
| | | $t = 8,3 \text{ ms}; (60 \text{ Hz}), \text{ sine}$ | $V_R = 0 V$ | | 240 | A | |
| I^2t | value for fusing | $t = 10 \text{ ms}; (50 \text{ Hz}), \text{ sine}$ | $T_{VJ} = 45^{\circ}C$ | | 340 | A ² s | |
| | | $t = 8,3 \text{ ms}; (60 \text{ Hz}), \text{ sine}$ | $V_R = 0 V$ | | 325 | A ² s | |
| | | $t = 10 \text{ ms}; (50 \text{ Hz}), \text{ sine}$ | $T_{VJ} = 150^{\circ}C$ | | 240 | A ² s | |
| | | $t = 8,3 \text{ ms}; (60 \text{ Hz}), \text{ sine}$ | $V_R = 0 V$ | | 240 | A ² s | |
| C_J | junction capacitance | $V_R = 400V \quad f = 1 \text{ MHz}$ | $T_{VJ} = 25^{\circ}C$ | | 9 | pF | |
| P_{GM} | max. gate power dissipation | $t_p = 30 \mu s$ | $T_C = 150^{\circ}C$ | | 10 | W | |
| | | $t_p = 300 \mu s$ | | | 5 | W | |
| P_{GAV} | average gate power dissipation | | | | 0,5 | W | |
| $(di/dt)_{cr}$ | critical rate of rise of current | $T_{VJ} = 125^{\circ}C; f = 50 \text{ Hz}$ repetitive, $I_T = 90 A$ | | | 150 | A/ μs | |
| | | $t_p = 200 \mu s; di_G/dt = 0,2 A/\mu s;$ $I_G = 0,2A; V_D = \frac{2}{3} V_{DRM}$ non-repet., $I_T = 30 A$ | | | 500 | A/ μs | |
| $(dv/dt)_{cr}$ | critical rate of rise of voltage | $V_D = \frac{2}{3} V_{DRM}$ $R_{GK} = \infty$; method 1 (linear voltage rise) | $T_{VJ} = 125^{\circ}C$ | | 500 | V/ μs | |
| V_{GT} | gate trigger voltage | $V_D = 6 V$ | $T_{VJ} = 25^{\circ}C$ | | 1,3 | V | |
| | | | $T_{VJ} = -40^{\circ}C$ | | 1,6 | V | |
| I_{GT} | gate trigger current | $V_D = 6 V$ | $T_{VJ} = 25^{\circ}C$ | | ± 60 | mA | |
| | | | $T_{VJ} = -40^{\circ}C$ | | ± 80 | mA | |
| V_{GD} | gate non-trigger voltage | $V_D = \frac{2}{3} V_{DRM}$ | $T_{VJ} = 125^{\circ}C$ | | 0,2 | V | |
| I_{GD} | gate non-trigger current | | | | ± 1 | mA | |
| I_L | latching current | $t_p = 10 \mu s$ | $T_{VJ} = 25^{\circ}C$ | | 90 | mA | |
| | | $I_G = 0,2A; di_G/dt = 0,2 A/\mu s$ | | | | | |
| I_H | holding current | $V_D = 6 V \quad R_{GK} = \infty$ | $T_{VJ} = 25^{\circ}C$ | | 60 | mA | |
| t_{gd} | gate controlled delay time | $V_D = \frac{1}{2} V_{DRM}$ | $T_{VJ} = 25^{\circ}C$ | | 2 | μs | |
| | | $I_G = 0,5A; di_G/dt = 0,5 A/\mu s$ | | | | | |
| t_q | turn-off time | $V_R = 100 V; I_T = 30A; V_D = \frac{2}{3} V_{DRM}$ $di/dt = 10 A/\mu s; dv/dt = 20 V/\mu s; t_p = 200 \mu s$ | $T_{VJ} = 125^{\circ}C$ | | 150 | μs | |



| Package TO-247 | | | Ratings | | | |
|----------------|------------------------------|--------------|---------|------|------|------|
| Symbol | Definition | Conditions | min. | typ. | max. | Unit |
| I_{RMS} | RMS current | per terminal | | | 70 | A |
| T_{VJ} | virtual junction temperature | | -40 | | 150 | °C |
| T_{op} | operation temperature | | -40 | | 125 | °C |
| T_{stg} | storage temperature | | -40 | | 150 | °C |
| Weight | | | | 6 | | g |
| M_D | mounting torque | | 0,8 | | 1,2 | Nm |
| F_C | mounting force with clip | | 20 | | 120 | N |

Product Marking



Part description

- C = Thyristor (SCR)
- M = Thyristor
- A = (up to 1800V)
- 60 = Current Rating [A]
- MT = 1~ Triac
- 1600 = Reverse Voltage [V]
- N = Three Quadrants operation: QI - QIII
- HB = TO-247AD (3)

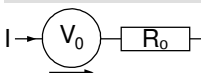
| Ordering | Ordering Number | Marking on Product | Delivery Mode | Quantity | Code No. |
|----------|-----------------|--------------------|---------------|----------|----------|
| Standard | CMA60MT1600NHB | CMA60MT1600NHB | Tube | 30 | 516795 |

| Similar Part | Package | Voltage class |
|----------------|------------|---------------|
| CMA60MT1600NHR | ISO247 (3) | 1600 |

Equivalent Circuits for Simulation

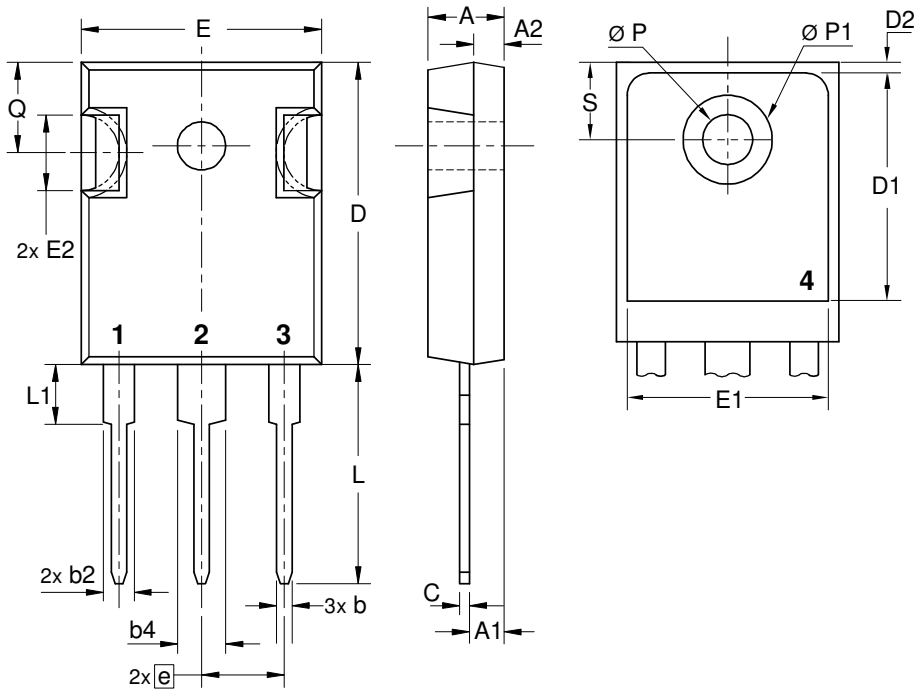
* on die level

$T_{VJ} = 150^{\circ}C$

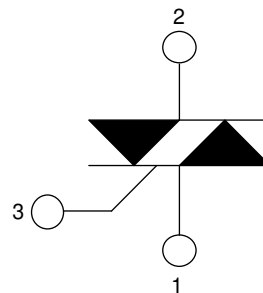


Thyristor

| | | | |
|--------------|--------------------|------|----|
| $V_{0 \max}$ | threshold voltage | 0,89 | V |
| $R_{0 \max}$ | slope resistance * | 12,6 | mΩ |

Outlines TO-247


| Sym. | Inches | | Millimeter | |
|------|-----------|-------|------------|-------|
| | min. | max. | min. | max. |
| A | 0.185 | 0.209 | 4.70 | 5.30 |
| A1 | 0.087 | 0.102 | 2.21 | 2.59 |
| A2 | 0.059 | 0.098 | 1.50 | 2.49 |
| D | 0.819 | 0.845 | 20.79 | 21.45 |
| E | 0.610 | 0.640 | 15.48 | 16.24 |
| E2 | 0.170 | 0.216 | 4.31 | 5.48 |
| e | 0.215 BSC | | 5.46 BSC | |
| L | 0.780 | 0.800 | 19.80 | 20.30 |
| L1 | - | 0.177 | - | 4.49 |
| Ø P | 0.140 | 0.144 | 3.55 | 3.65 |
| Q | 0.212 | | 5.38 | |
| S | 0.242 BSC | | 6.14 BSC | |
| b | 0.039 | 0.055 | 0.99 | 1.40 |
| b2 | 0.065 | 0.094 | 1.65 | 2.39 |
| b4 | 0.102 | 0.135 | 2.59 | 3.43 |
| c | 0.015 | 0.035 | 0.38 | 0.89 |
| D1 | 0.515 | - | 13.07 | - |
| D2 | 0.020 | 0.053 | 0.51 | 1.35 |
| E1 | 0.530 | - | 13.45 | - |
| Ø P1 | - | 0.29 | - | 7.39 |



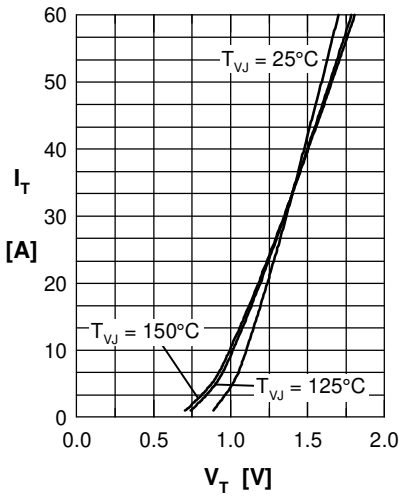
Thyristor


Fig. 1 Forward characteristics

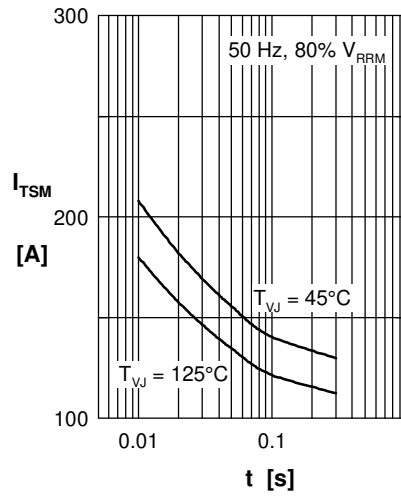
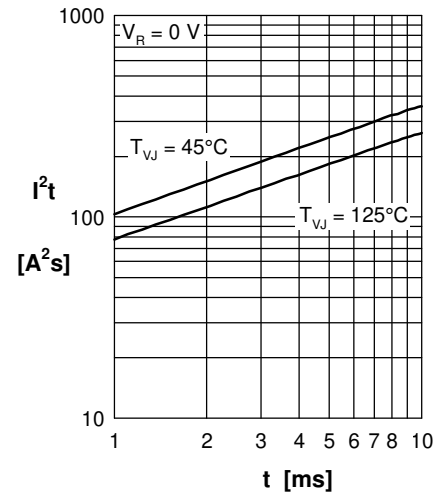
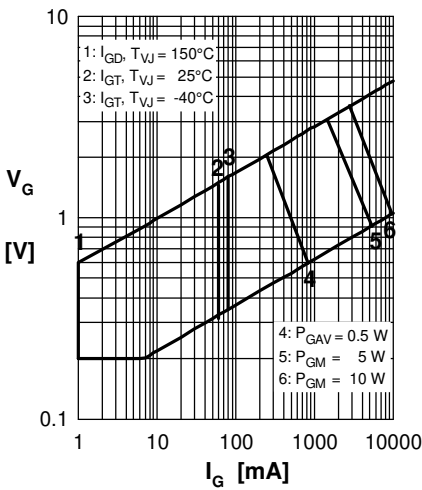

 Fig. 2 Surge overload current
 I_{TSM} : crest value, t : duration

 Fig. 3 I^2t versus time (1-10 s)


Fig. 4 Gate voltage & gate current

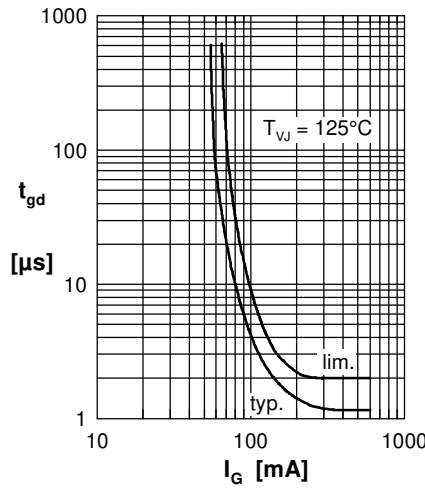
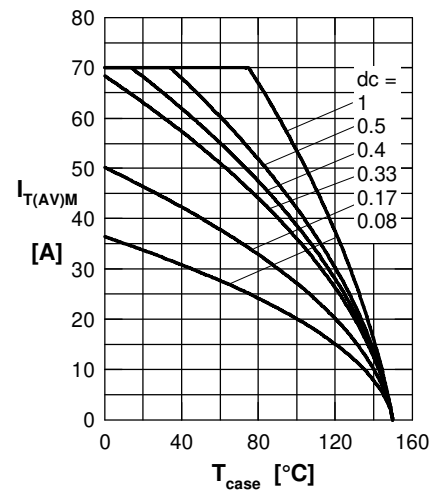

 Fig. 5 Gate controlled delay time t_{gd}


Fig. 6 Max. forward current at case temperature

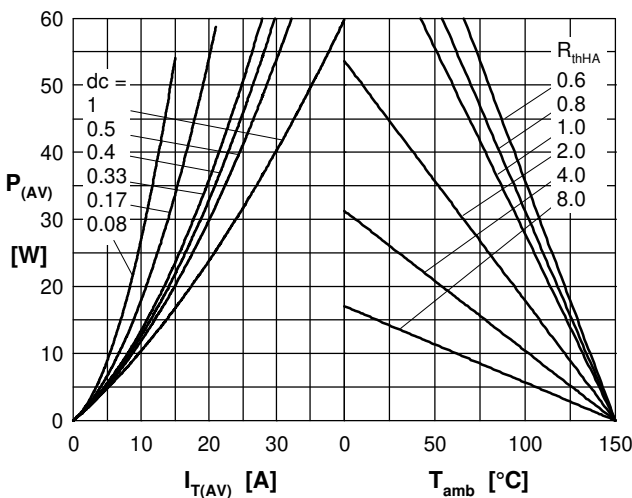
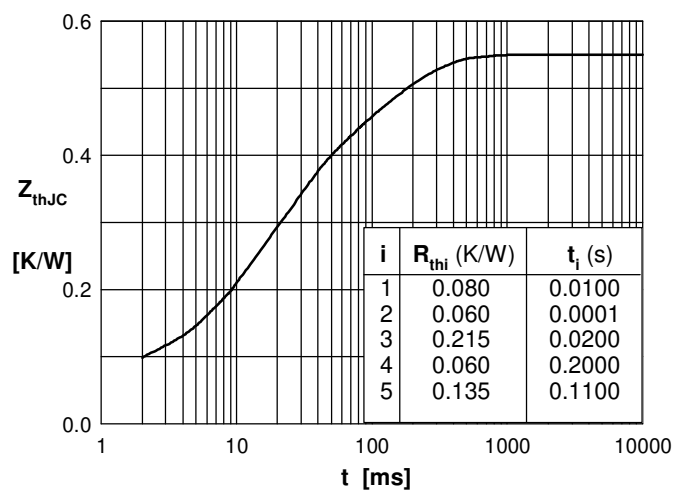

 Fig. 7a Power dissipation versus direct output current
 Fig. 7b and ambient temperature


Fig. 8 Transient thermal impedance junction to case