

Thyristor

$$V_{RRM} = 1600\text{ V}$$

$$I_{TAV} = 50\text{ A}$$

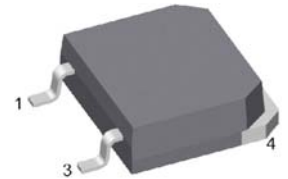
$$V_T = 1,31\text{ V}$$

Single Thyristor

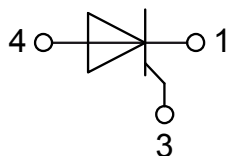
Part number

CMA50E1600TZ

Marking on Product: CMA50E1600TZ



Backside: anode



Features / Advantages:

- Thyristor for line frequency
- Planar passivated chip
- Long-term stability

Applications:

- Line rectifying 50/60 Hz
- Softstart AC motor control
- DC Motor control
- Power converter
- AC power control
- Lighting and temperature control

Package: TO-268AA (D3Pak-HV)

- Industry standard outline
- RoHS compliant
- Epoxy meets UL 94V-0
- High creepage distance between terminals

Disclaimer Notice

Information furnished is believed to be accurate and reliable. However, users should independently evaluate the suitability of and test each product selected for their own applications. Littelfuse products are not designed for, and may not be used in, all applications. Read complete Disclaimer Notice at www.littelfuse.com/disclaimer-electronics.

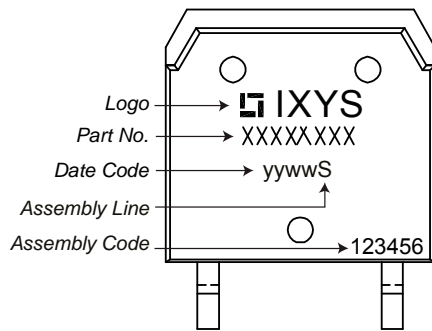


Thyristor				Ratings			
Symbol	Definition	Conditions	min.	typ.	max.	Unit	
$V_{RSM/DSM}$	max. non-repetitive reverse/forward blocking voltage	$T_{VJ} = 25^{\circ}C$			1700	V	
$V_{RRM/DRM}$	max. repetitive reverse/forward blocking voltage	$T_{VJ} = 25^{\circ}C$			1600	V	
I_{RD}	reverse current, drain current	$V_{RD} = 1600 V$	$T_{VJ} = 25^{\circ}C$		50	μA	
		$V_{RD} = 1600 V$	$T_{VJ} = 125^{\circ}C$		5	mA	
V_T	forward voltage drop	$I_T = 50 A$	$T_{VJ} = 25^{\circ}C$		1,30	V	
					1,66	V	
		$I_T = 100 A$	$T_{VJ} = 125^{\circ}C$		1,31	V	
					1,77	V	
I_{TAV}	average forward current	$T_C = 110^{\circ}C$	$T_{VJ} = 150^{\circ}C$		50	A	
$I_{T(RMS)}$	RMS forward current	180° sine			79	A	
V_{T0}	threshold voltage	} for power loss calculation only	$T_{VJ} = 150^{\circ}C$		0,83	V	
r_T	slope resistance				9,6	m Ω	
R_{thJC}	thermal resistance junction to case				0,4	K/W	
R_{thCH}	thermal resistance case to heatsink			0,15		K/W	
P_{tot}	total power dissipation		$T_C = 25^{\circ}C$		310	W	
I_{TSM}	max. forward surge current	t = 10 ms; (50 Hz), sine	$T_{VJ} = 45^{\circ}C$		550	A	
			$V_R = 0 V$		595	A	
		t = 8,3 ms; (60 Hz), sine	$T_{VJ} = 150^{\circ}C$		470	A	
			$V_R = 0 V$		505	A	
I^2t	value for fusing	t = 10 ms; (50 Hz), sine	$T_{VJ} = 45^{\circ}C$		1,52	kA ² s	
			$V_R = 0 V$		1,48	kA ² s	
		t = 8,3 ms; (60 Hz), sine	$T_{VJ} = 150^{\circ}C$		1,11	kA ² s	
			$V_R = 0 V$		1,06	kA ² s	
C_J	junction capacitance	$V_R = 400 V$ f = 1 MHz	$T_{VJ} = 25^{\circ}C$		26	pF	
P_{GM}	max. gate power dissipation	$t_p = 30 \mu s$	$T_C = 150^{\circ}C$		10	W	
		$t_p = 300 \mu s$			5	W	
P_{GAV}	average gate power dissipation				0,5	W	
$(di/dt)_{cr}$	critical rate of rise of current	$T_{VJ} = 150^{\circ}C$; f = 50 Hz	repetitive, $I_T = 150 A$		150	A/ μs	
			$t_p = 200 \mu s$; $di_G/dt = 0,3 A/\mu s$;				
			$I_G = 0,3 A$; $V_D = \frac{2}{3} V_{DRM}$ non-repet., $I_T = 50 A$		500	A/ μs	
$(dv/dt)_{cr}$	critical rate of rise of voltage	$V_D = \frac{2}{3} V_{DRM}$	$T_{VJ} = 150^{\circ}C$		1000	V/ μs	
V_{GT}	gate trigger voltage	$V_D = 6 V$	$T_{VJ} = 25^{\circ}C$		1,5	V	
			$T_{VJ} = -40^{\circ}C$		1,6	V	
I_{GT}	gate trigger current	$V_D = 6 V$	$T_{VJ} = 25^{\circ}C$		50	mA	
			$T_{VJ} = -40^{\circ}C$		80	mA	
V_{GD}	gate non-trigger voltage	$V_D = \frac{2}{3} V_{DRM}$	$T_{VJ} = 140^{\circ}C$		0,2	V	
I_{GD}	gate non-trigger current				5	mA	
I_L	latching current	$t_p = 10 \mu s$	$T_{VJ} = 25^{\circ}C$		125	mA	
			$I_G = 0,3 A$; $di_G/dt = 0,3 A/\mu s$				
I_H	holding current	$V_D = 6 V$ $R_{GK} = \infty$	$T_{VJ} = 25^{\circ}C$		100	mA	
t_{gd}	gate controlled delay time	$V_D = \frac{1}{2} V_{DRM}$	$T_{VJ} = 25^{\circ}C$		2	μs	
			$I_G = 0,3 A$; $di_G/dt = 0,3 A/\mu s$				
t_q	turn-off time	$V_R = 100 V$; $I_T = 50 A$; $V_D = \frac{2}{3} V_{DRM}$	$T_{VJ} = 125^{\circ}C$		150	μs	
		$di/dt = 10 A/\mu s$ $dv/dt = 20 V/\mu s$ $t_p = 200 \mu s$					



Package TO-268AA (D3Pak-HV)			Ratings			
Symbol	Definition	Conditions	min.	typ.	max.	Unit
I_{RMS}	RMS current	per terminal			70	A
T_{VJ}	virtual junction temperature		-40		150	°C
T_{op}	operation temperature		-40		125	°C
T_{stg}	storage temperature		-40		150	°C
Weight				4		g
F_C	mounting force with clip		20		120	N
$d_{Spp/App}$	creepage distance on surface striking distance through air	terminal to terminal	9,4			mm
$d_{Spb/Apb}$		terminal to backside	5,6			mm

Product Marking



Part description

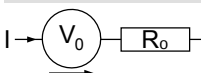
- C = Thyristor (SCR)
- M = Thyristor
- A = (up to 1800V)
- 50 = Current Rating [A]
- E = Single Thyristor
- 1600 = Reverse Voltage [V]
- TZ = TO-268AA (D3Pak) (2HV)

Ordering	Ordering Number	Marking on Product	Delivery Mode	Quantity	Code No.
Standard	CMA50E1600TZ-TUB	CMA50E1600TZ	Tube	30	513202
Alternative	CMA50E1600TZ-TRL	CMA50E1600TZ	Tape & Reel	400	525510

Equivalent Circuits for Simulation

* on die level

$T_{VJ} = 150^{\circ}C$

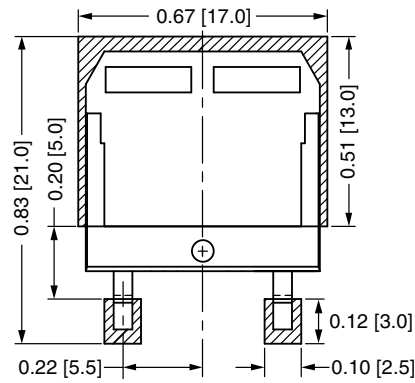
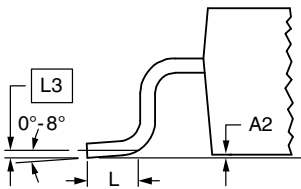
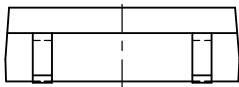
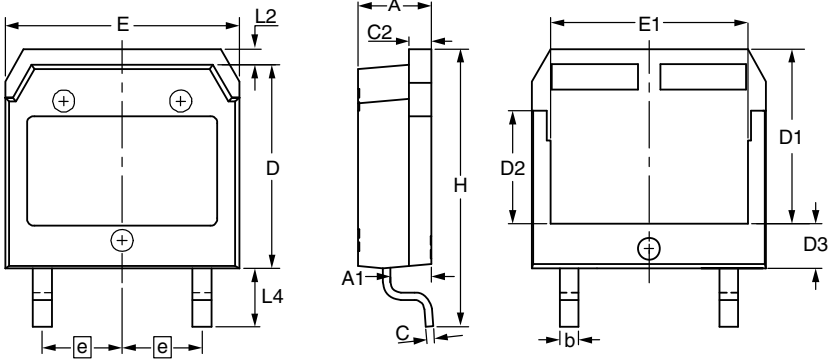


Thyristor

$V_{0\ max}$	threshold voltage	0,83	V
$R_{0\ max}$	slope resistance *	7	mΩ

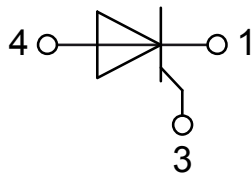


Outlines TO-268AA (D3Pak-HV)



RECOMMENDED MINIMUM FOOT PRINT

Dim.	Millimeter		Inches	
	min	max	min	max
A	4.90	5.10	0.193	0.201
A1	2.70	2.90	0.106	0.114
A2	0.02	0.25	0.001	0.010
b	1.15	1.45	0.045	0.057
C	0.40	0.65	0.016	0.026
C2	1.45	1.60	0.057	0.063
D	13.80	14.00	0.543	0.551
D1	11.80	12.10	0.465	0.476
D2	7.50	7.80	0.295	0.307
D3	2.90	3.20	0.114	0.126
E	15.85	16.05	0.624	0.632
E1	13.30	13.60	0.524	0.535
e	5.450 BSC		0.215 BSC	
H	18.70	19.10	0.736	0.752
L	1.70	2.00	0.067	0.079
L2	1.00	1.15	0.039	0.045
L3	0.250 BSC		0.010 BSC	
L4	3.80	4.10	0.150	0.161



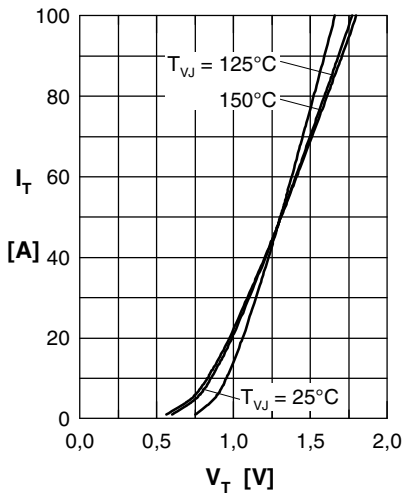
Thyristor


Fig. 1 Forward characteristics

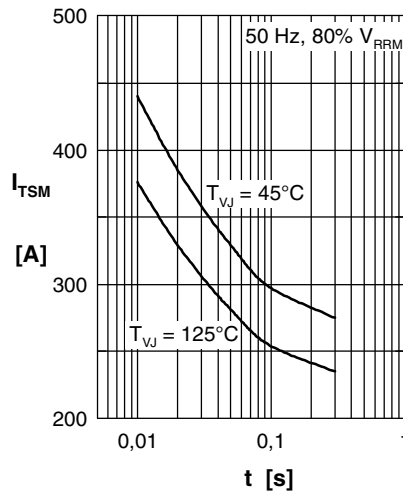
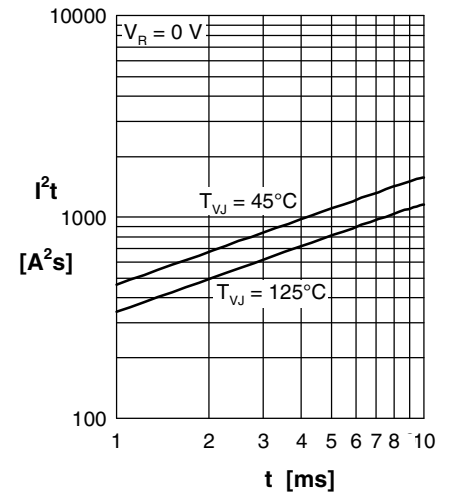
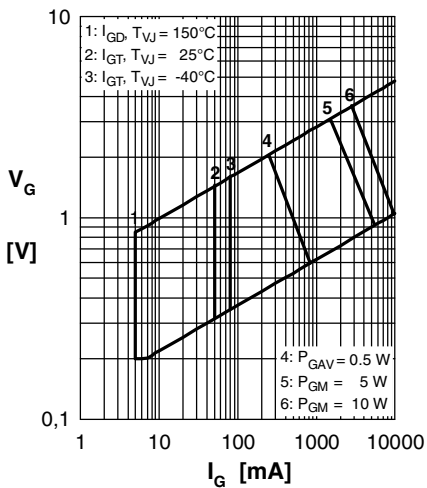

 Fig. 2 Surge overload current
 I_{TSM} : crest value, t : duration

 Fig. 3 I^2t versus time (1-10 s)


Fig. 4 Gate voltage & gate current

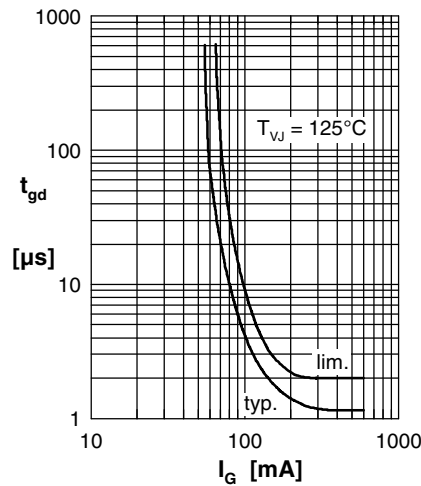
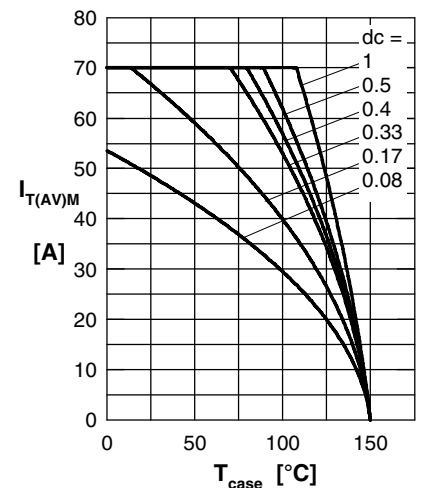

 Fig. 5 Gate controlled delay time t_{gd}


Fig. 6 Max. forward current at case temperature

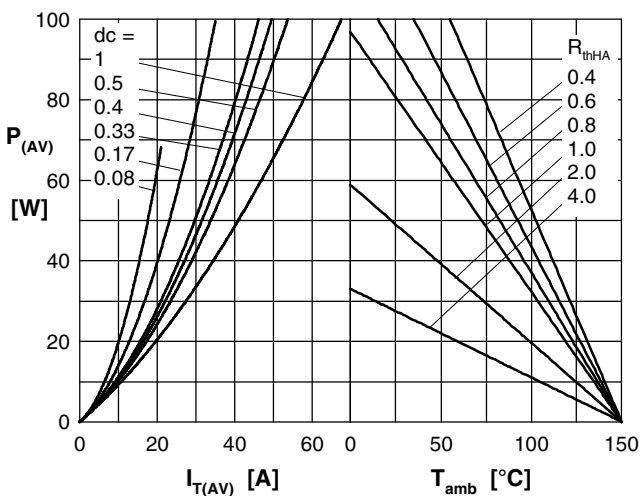
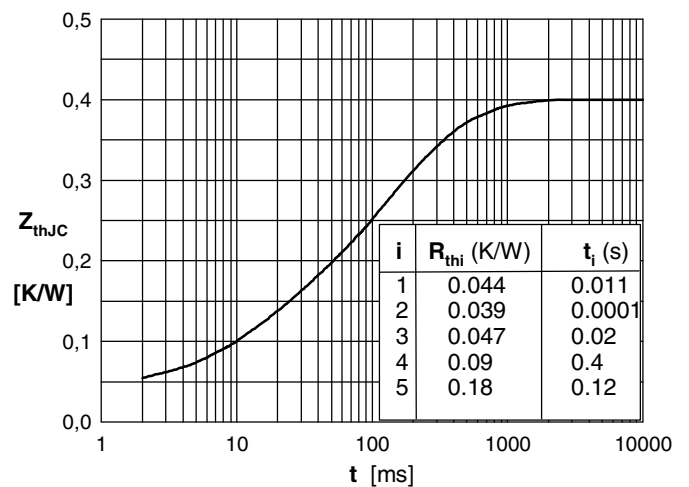

 Fig. 7a Power dissipation versus direct output current
 Fig. 7b and ambient temperature


Fig. 7 Transient thermal impedance junction to case