

### DUR1040CT

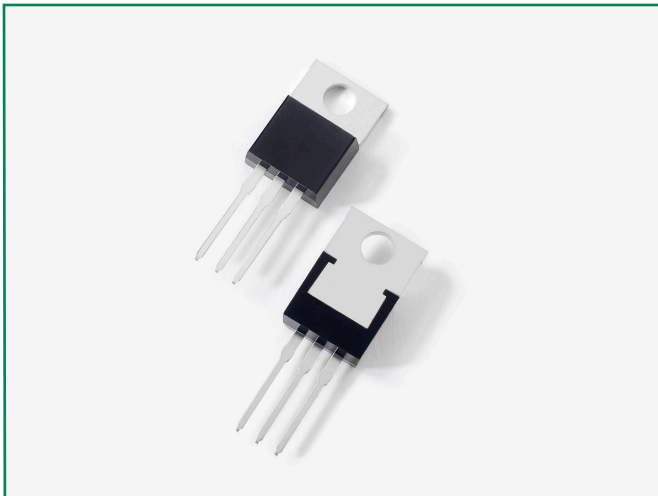

#### Description

Littelfuse DUR series Ultrafast Recovery Rectifier is designed to meet the general requirements of commercial applications by providing low  $T_{rr}$ , high-temperature, low-leakage and low forward voltage drop products. It is suitable for output rectifier, free-wheeling or boost diode in high-frequency power switching application such as switch mode power supply and DC-DC converters.

#### Features

- Ultra-fast switching
  - Low reverse leakage current
  - High surge current capability
  - Low forward voltage drop
  - Common Cathode
- configuration in TO-220AB package
- Pb-free E3 means 2nd level interconnect is Pb-free and the terminal finish material is tin(Sn) (IPC/ JEDEC J-STD-609A.01)

#### Circuit Diagram

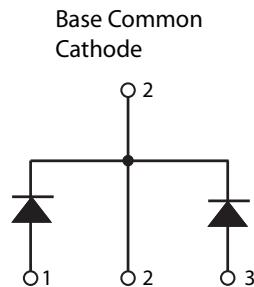

#### Applications

- Output rectifiers in switch mode power supplies (SMPS) and DC to DC converters
- Free-wheeling diode or boost diode in converters and motor control circuits
- Anti-parallel diode for high frequency switching devices such as IGBT
- Uninterruptible Power Supplies (UPS)
- Inductive heating and melting
- Ultrasonic cleaners and welders

#### Maximum Ratings

Characteristics	Symbol	Conditions	Max.	Unit
Peak Inverse Voltage	$V_{RWM}$	-	400	V
Average Forward Current	$I_{FAV}$	50% duty cycle @ $T_C = 112^\circ\text{C}$ , rectangular wave form	5 (Per Leg) 10 (Total Device)	A
Peak One Cycle Non-Repetitive Surge Current ( Per Leg)	$I_{FSM}$	8.3 ms, half sine pulse	80	A

#### Electrical Characteristics

Characteristics	Symbol	Conditions	Max.	Unit
Forward Voltage Drop (Per Leg) <sup>1</sup>	$V_F$	@5A, Pulse, $T_J = 25^\circ\text{C}$	1.3	V
Reverse Current <sup>1</sup>	$I_{R1}$	@ $V_R = \text{Rated } V_R, T_J = 25^\circ\text{C}$	30	$\mu\text{A}$
	$I_{R2}$	@ $V_R = \text{Rated } V_R, T_J = 125^\circ\text{C}$	300	
Reverse Recovery Time	$t_{rr1}$	$I_F = 500\text{mA}, I_R = 1\text{A}, \text{ and } I_{rm} = 250\text{mA}$	45	ns

Footnote 1: Pulse Width < 300 $\mu\text{s}$ , Duty Cycle < 2%

### Thermal-Mechanical Specifications

Characteristics	Symbol	Conditions	Specification	Unit
Junction Temperature	$T_J$	-	-55 to +150	°C
Storage Temperature	$T_{stg}$	-	-55 to +150	°C
Typical Thermal Resistance Junction to Case	$R_{\theta JC}$	DC operation	3.5	°C/W
Approximate Weight	wt	-	2	g
Case Style	-	TO-220AB	-	-

#### Figure 1: Typical Forward Characteristics

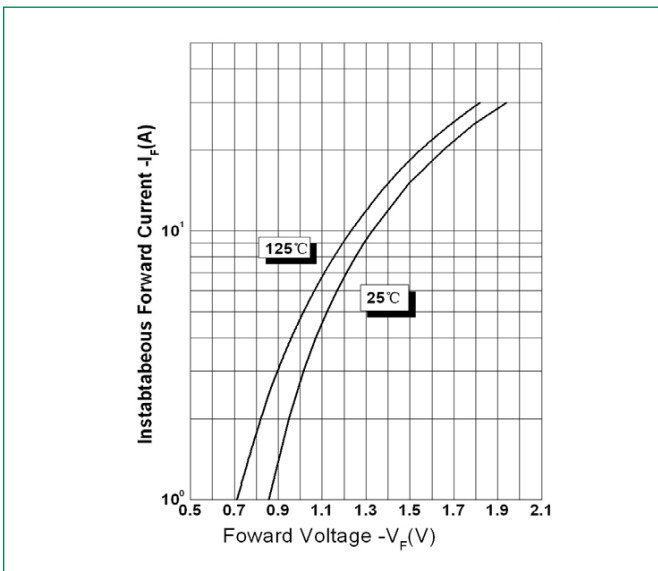

#### Figure 2: Typical Reverse Characteristics

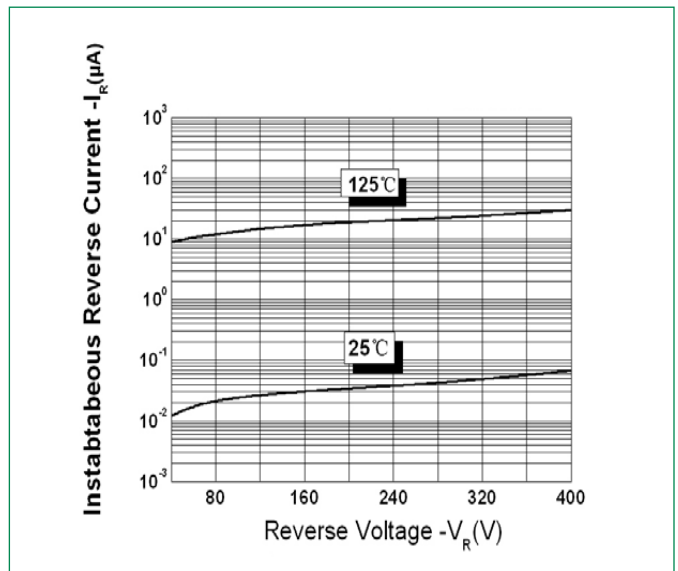

#### Figure 3: Typical Junction Capacitance

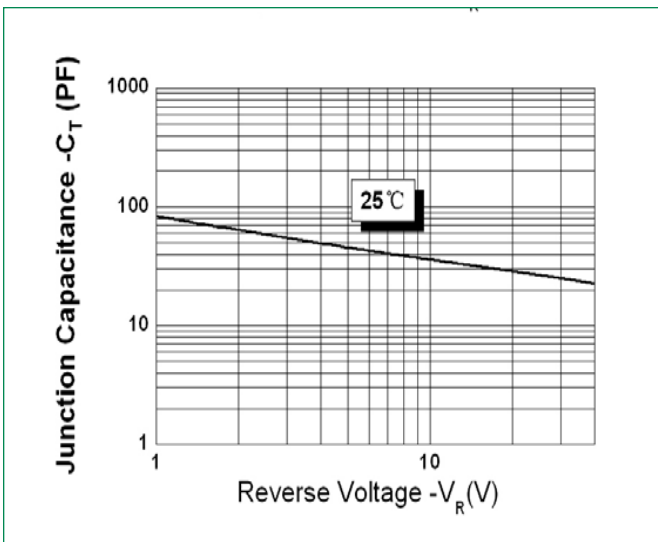

#### Part Numbering and Marking System

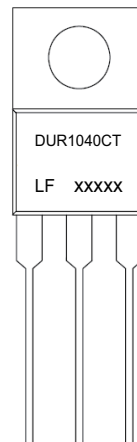

\*xxxxx is YYWWL

- DUR = Device Type
- 10 = Forward Current (10A)
- 40 = Reverse Voltage (400V)
- CT = Configuration
- LF = Littelfuse
- YY = Year
- WW = Week
- L = Lot Number

# Ultrafast Recovery Rectifier

## DUR1040CT, 2x 5A, 400V, TO-220AB, Common Cathode

### Packing Options

Part Number	Marking	Packing Mode	M.O.Q
DUR1040CT	DUR1040CT	50pcs /Tube	1000

### Dimensions-Package TO-220AB

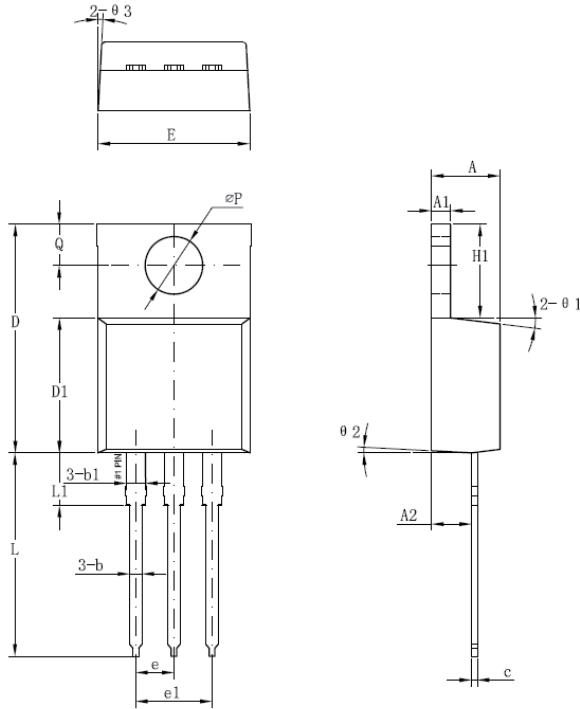

Symbol	Millimeters	
	Min	Max
A	3.56	4.83
A1	0.51	1.40
A2	2.03	2.92
b	0.38	1.02
b1	1.14	1.78
c	0.31*	0.61
D	14.22	16.51
D1	8.38	9.15*
E	9.65	10.67
e	2.54	-
e1	4.98*	-
H1	5.84	6.86
L	12.70	14.73
L1	-	6.35
øP	3.53	4.09
Q	2.54	3.43

Footnote \*: The spec. does not comply with JEDEC spec.

### Tube Specification TO-220AB

