

## LSIC2SD120A20A 1200 V, 20 A SiC Schottky Barrier Diode

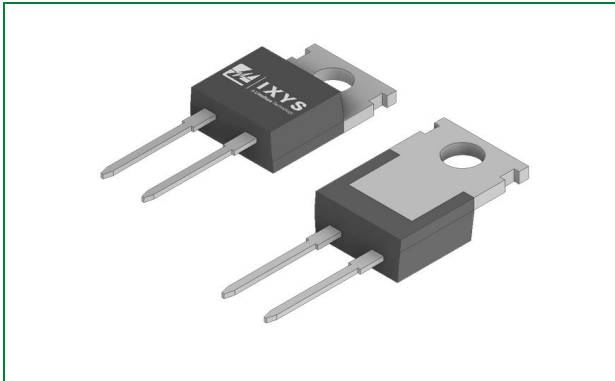

### Agency Approvals and Environmental

Environmental Approvals



### Circuit Diagram TO-220-2L

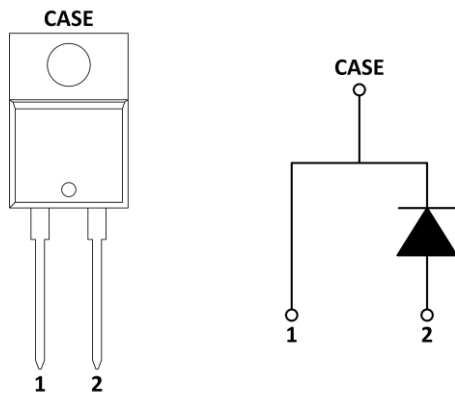

### Product Summary

| Characteristic                     | Value | Unit |
|------------------------------------|-------|------|
| $V_{RRM}$                          | 1200  | V    |
| $I_F (T_c \leq 135^\circ\text{C})$ | 26    | A    |
| $Q_c (V_R: 0 - 800\text{ V})$      | 125   | nC   |

### Features

- AEC-Q101 qualified
- Positive temperature coefficient for safe operation and ease of paralleling
- 175 °C maximum operating junction temperature
- Excellent surge capability
- Extremely fast, temperature-independent switching behavior
- Dramatically reduced switching losses compared to Si bipolar diodes
- RoHS compliant, lead-free, and halogen-free

### Applications

- Boost diodes in PFC or DC/DC stages
- Switch-mode power supplies
- Solar inverters
- Uninterruptable power supplies
- Industrial motor drives
- Battery chargers
- High speed rectifier

- 1. Maximum Ratings.....3
- 2. Thermal Characteristics .....3
- 3. Electrical Characteristics ( $T_J = 25\text{ }^\circ\text{C}$  unless otherwise specified) .....3
- 4. Performance Curves .....4
- 5. Diode  $V_F$  Model for Simulation .....5
- 6. Package Dimensions .....6
- 7. Part Numbering and Marking.....6
- 8. Packing Options .....6
- 9. Packing Specifications .....7

## 1. Maximum Ratings

| Characteristic                       | Symbol        | Conditions                                                                | Value      | Unit             |
|--------------------------------------|---------------|---------------------------------------------------------------------------|------------|------------------|
| Repetitive Peak Reverse Voltage      | $V_{RRM}$     | -                                                                         | 1200       | V                |
| DC Blocking Voltage                  | $V_R$         | -                                                                         | 1200       | V                |
| Continuous Forward Current           | $I_F$         | $T_C = 25\text{ }^\circ\text{C}$                                          | 55         | A                |
|                                      |               | $T_C = 135\text{ }^\circ\text{C}$                                         | 26         |                  |
|                                      |               | $T_C = 149\text{ }^\circ\text{C}$                                         | 20         |                  |
| Non-repetitive Forward Surge Current | $I_{FSM}$     | $T_C = 25\text{ }^\circ\text{C}$ , $t_p = 10\text{ ms}$ , Half sine pulse | 145        | A                |
| $I^2t$                               | $\int I^2 dt$ | $T_C = 25\text{ }^\circ\text{C}$ , $t_p = 10\text{ ms}$ , Half sine pulse | 105        | A <sup>2</sup> s |
| Power Dissipation                    | $P_{Tot}$     | $T_C = 25\text{ }^\circ\text{C}$                                          | 250        | W                |
|                                      |               | $T_C = 110\text{ }^\circ\text{C}$                                         | 108        |                  |
| Operating Junction Temperature       | $T_J$         | -                                                                         | -55 to 175 | $^\circ\text{C}$ |
| Storage Temperature                  | $T_{STG}$     | -                                                                         | -55 to 150 | $^\circ\text{C}$ |
| Lead Temperature for Soldering       | $T_{SOLD}$    | -                                                                         | 260        | $^\circ\text{C}$ |
| Mounting Torque                      | $M_D$         | M3 or 6-32 screw                                                          | 1.0        | Nm               |
|                                      |               |                                                                           | 8.8        | in-lb            |

## 2. Thermal Characteristics

| Characteristic             | Symbol           | Value | Unit               |
|----------------------------|------------------|-------|--------------------|
| Maximum Thermal Resistance | $R_{th,JC, max}$ | 0.6   | $^\circ\text{C/W}$ |

## 3. Electrical Characteristics ( $T_J = 25\text{ }^\circ\text{C}$ unless otherwise specified)

| Characteristic            | Symbol | Conditions                                                | Value |      |     | Unit          |
|---------------------------|--------|-----------------------------------------------------------|-------|------|-----|---------------|
|                           |        |                                                           | Min   | Typ  | Max |               |
| Forward Voltage           | $V_F$  | $I_F = 20\text{ A}$ , $T_J = 25\text{ }^\circ\text{C}$    | -     | 1.5  | 1.8 | V             |
|                           |        | $I_F = 20\text{ A}$ , $T_J = 175\text{ }^\circ\text{C}$   | -     | 2.1  | -   |               |
| Reverse Current           | $I_R$  | $V_R = 1200\text{ V}$ , $T_J = 25\text{ }^\circ\text{C}$  | -     | <1   | 100 | $\mu\text{A}$ |
|                           |        | $V_R = 1200\text{ V}$ , $T_J = 175\text{ }^\circ\text{C}$ | -     | 8    | -   |               |
| Total Capacitance         | C      | $V_R = 1\text{ V}$ , $f = 1\text{ MHz}$                   | -     | 1310 | -   | pF            |
|                           |        | $V_R = 400\text{ V}$ , $f = 1\text{ MHz}$                 | -     | 120  | -   |               |
|                           |        | $V_R = 800\text{ V}$ , $f = 1\text{ MHz}$                 | -     | 86   | -   |               |
| Total Capacitive Charge   | $Q_C$  | $V_R = 800\text{ V}$ , $Q_C = \int C(V) dV$               | -     | 125  | -   | nC            |
| Capacitance Stored Energy | $E_C$  | $V_R = 800\text{ V}$                                      | -     | 28   | -   | $\mu\text{J}$ |

4. Performance Curves

Figure 1. Typical Forward Characteristics

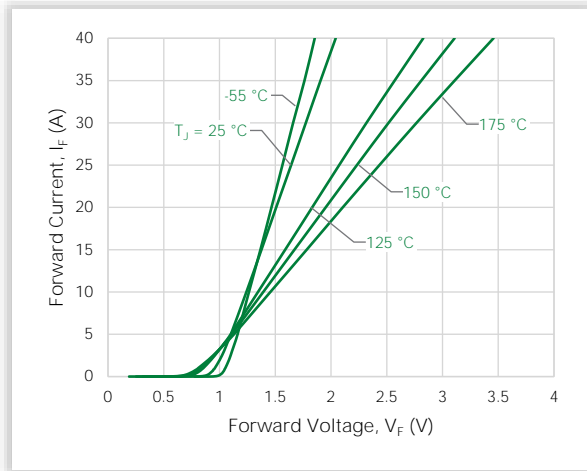

Figure 2. Typical Reverse Characteristics

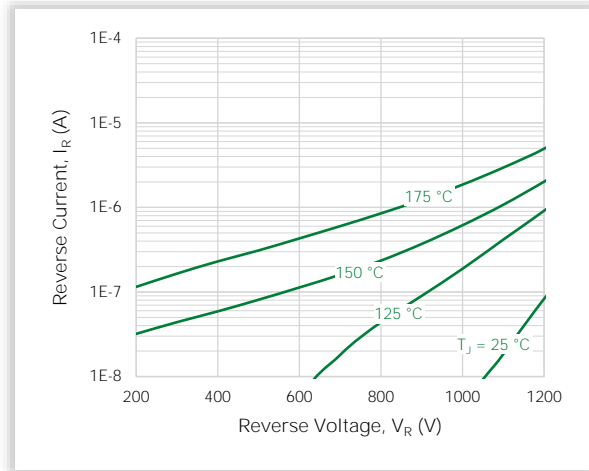

Figure 3. Power Derating

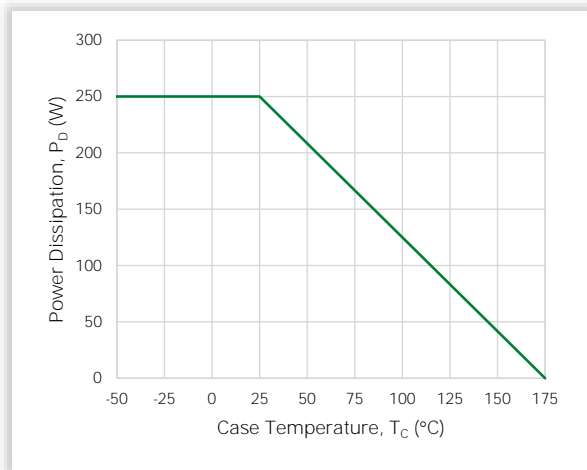

Figure 4. Current Derating

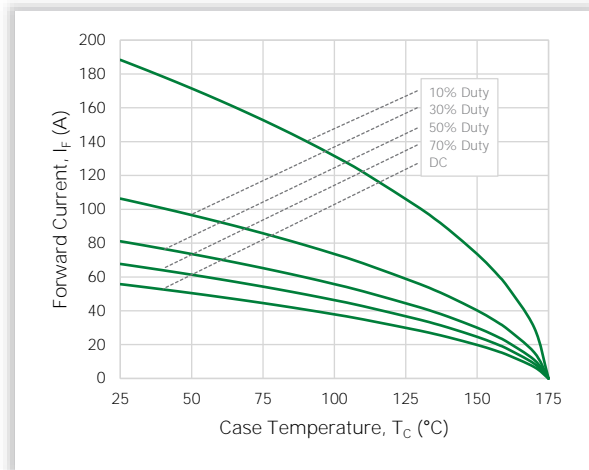

Figure 5. Capacitance vs. Reverse Voltage

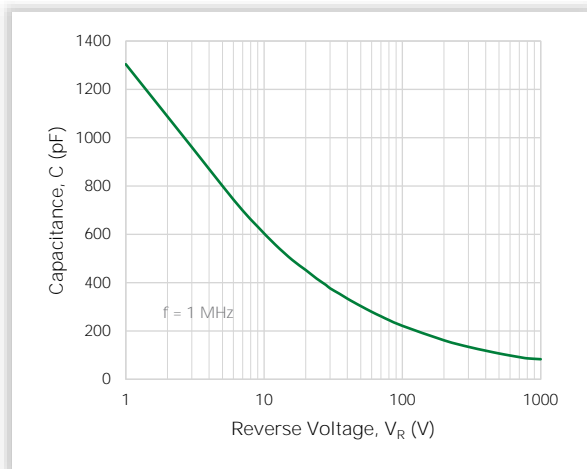

Figure 6. Capacitive Charge vs. Reverse Voltage

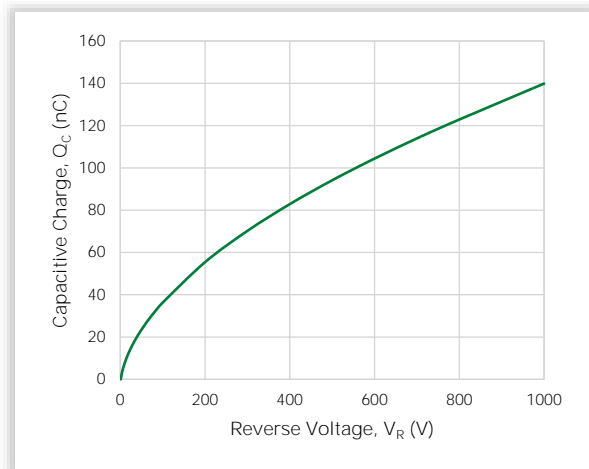

Figure 7. Stored Energy vs. Reverse Voltage

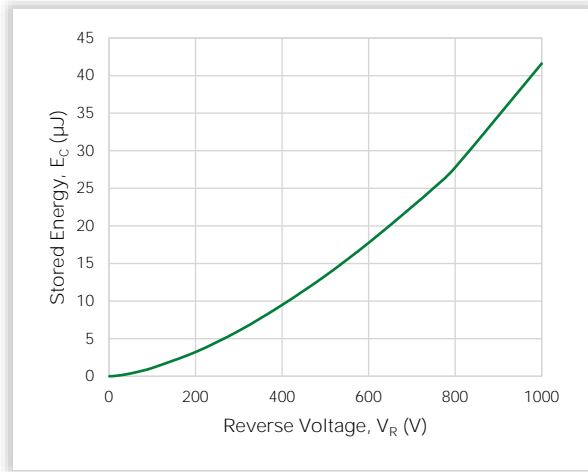
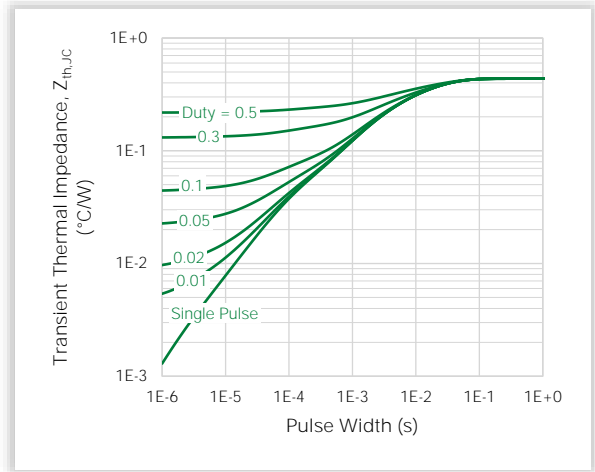
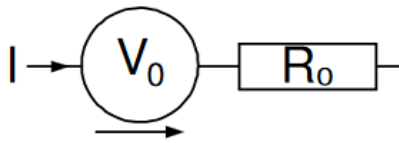

Figure 8. Transient Thermal Impedance



### 5. Diode V<sub>F</sub> Model for Simulation



$$V_F(T_J) = V_0 + IR_0$$

$$V_0 = -1.30 \times 10^{-3} \cdot T_J + 1.01 \times 10^0$$

$$R_0 = 8.15 \times 10^{-7} \cdot T_J^2 + 1.03 \times 10^{-4} \cdot T_J + 2.36 \times 10^{-2}$$

Notes:

- T<sub>J</sub> is junction temperature in °C
- Range valid from 25 °C to 175 °C
- Model represents performance of a typical part

### 6. Package Dimensions

TO-220-2L Package

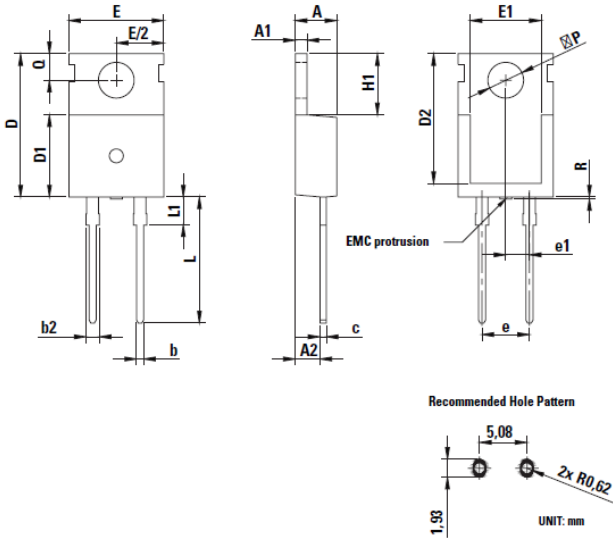

| Symbol | Millimeters |       |       |
|--------|-------------|-------|-------|
|        | Min         | Nom   | Max   |
| A      | 4.30        | 4.45  | 4.70  |
| A1     | 1.14        | 1.27  | 1.40  |
| A2     | 2.20        | -     | 2.74  |
| b      | 0.69        | -     | 0.90  |
| b2     | 1.17        | -     | 1.62  |
| c      | 0.36        | -     | 0.60  |
| D      | 14.90       | -     | 15.90 |
| D1     | 8.62        | -     | 9.40  |
| D2     | 12.50       | -     | 12.95 |
| E      | 9.70        | 10.18 | 10.36 |
| E1     | 7.57        | 7.61  | 8.30  |
| e1     | -           | 2.54  | -     |
| e      | 5.03        | 5.08  | 5.13  |
| H1     | 6.30        | 6.55  | 6.80  |
| L      | 12.88       | 13.50 | 14.00 |
| L1     | 2.39        | -     | 3.25  |
| øP     | 3.50        | 3.84  | 3.96  |
| Q      | 2.65        | -     | 3.05  |
| R      | -           | -     | 0.25  |

### 7. Part Numbering and Marking

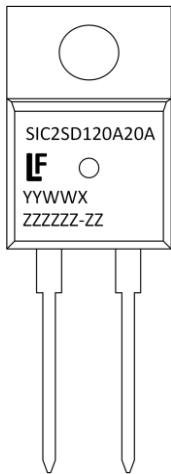

- Sic = Sic Diode
- 2 = Gen2
- SD = Schottky Diode
- 120 = Voltage Rating (1200 V)
- A = TO-220-2L
- 20 = Current Rating (20 A)
- A = AEC-Q101 Qualified
- YY = Year
- WW = Week
- X = Special Code
- ZZZZZZ-ZZ = Lot Number

### 8. Packing Options

| Part Number    | Marking       | Packing Mode  | M.O.Q. |
|----------------|---------------|---------------|--------|
| LSIC2SD120A20A | SIC2SD120A20A | Tube (50 pcs) | 1000   |

### 9. Packing Specifications

Tube for TO-220-2L

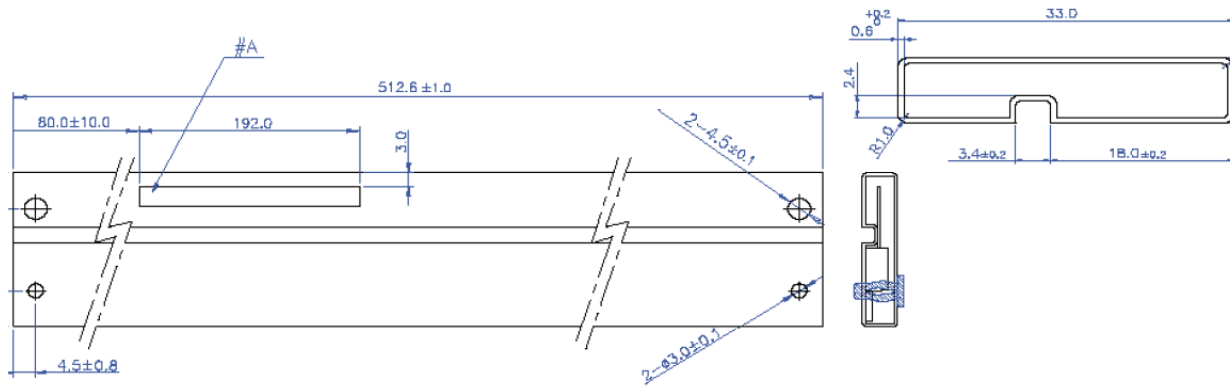

**NOTE ]**

- TUBE
  - MATERIAL : PVC / PET (WITH ANTISTATIC COATING)
  - COLOR : TRANSPARENCY, RED, YELLOW
  - MARKING #A : BLACK COLOR, LETTER STYLE : Arial
  - Tube Surface Resistance :  $10^9 \sim 10^{11} \Omega$ /square
  - ESD (Electro Static Discharge) : less than 100 [volts], 6 Months
  - CAMBAR : 1.5 MAX
- PIN
  - COLOR : GREEN (ONE PIN MUST BE INSERTED IN LEFT-SIDE OF "ANTISTATIC-" AND ANOTHER PIN IS FREE.)

For additional information please visit [www.Littelfuse.com/powersemi](http://www.Littelfuse.com/powersemi)

Disclaimer Notice - Littelfuse products are not designed for, and shall not be used for, any purpose (including, without limitation, automotive, military, aerospace, medical, life-saving, life-sustaining or nuclear facility applications, devices intended for surgical implant into the body, or any other application in which the failure or lack of desired operation of the product may result in personal injury, death, or property damage) other than those expressly forth in applicable Littelfuse product documentation. Littelfuse shall not be liable for any claims or damages arising out of products used in applications not expressly intended by Littelfuse as set forth in applicable Littelfuse documentation.

Read complete Disclaimer Notice at [www.littelfuse.com/disclaimer-electronics](http://www.littelfuse.com/disclaimer-electronics)