

## LSIC2SD065C06A 650 V, 6 A SiC Schottky Barrier Diode

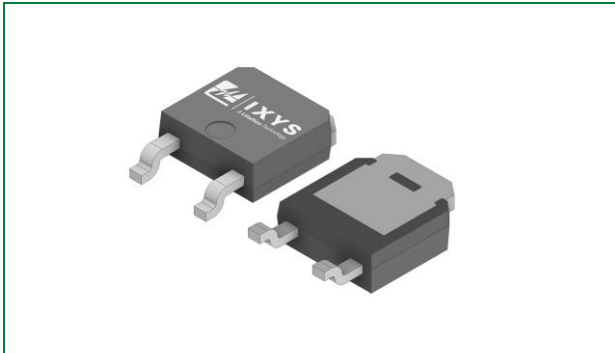

### Agency Approvals and Environmental

Environmental Approvals



### Circuit Diagram TO-252-2L

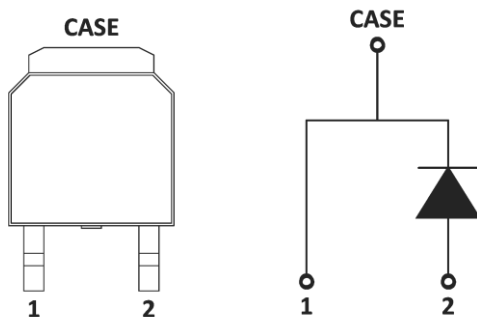

### Product Summary

Characteristic	Value	Unit
$V_{RRM}$	650	V
$I_F (T_C \leq 135\text{ }^\circ\text{C})$	8.5	A
$Q_c (V_R: 0 - 400\text{ V})$	20	nC

### Features

- AEC-Q101 Qualified
- MSL 1 Rated
- Positive temperature coefficient for safe operation and ease of paralleling
- 175 °C maximum operating junction temperature
- Excellent surge capability
- Extremely fast, temperature-independent switching behavior
- Dramatically reduced switching losses compared to Si bipolar diodes
- RoHS compliant, lead-free, and halogen-free

### Applications

- Boost diodes in PFC or DC/DC stages
- Switch-mode power supplies
- Solar inverters
- Uninterruptable power supplies
- Industrial motor drives
- Battery chargers
- High speed rectifier

1. Maximum Ratings.....3  
2. Thermal Characteristics .....3  
3. Electrical Characteristics .....3  
4. Performance Curves .....4  
5.  $V_f$  Model for Simulations .....5  
6. Package Dimensions .....6  
7. Part Numbering and Marking.....7  
8. Packing Options .....7  
9. Packing Specifications .....7

## 1. Maximum Ratings

Characteristic	Symbol	Conditions	Value	Unit
Repetitive Peak Reverse Voltage	$V_{RRM}$	-	650	V
DC Blocking Voltage	$V_R$	-	650	V
Continuous Forward Current	$I_F$	$T_C = 25\text{ °C}$	18.5	A
		$T_C = 135\text{ °C}$	8.5	
		$T_C = 152\text{ °C}$	6	
Non-repetitive Forward Surge Current	$I_{FSM}$	$T_C = 25\text{ °C}$ , $t_p = 10\text{ ms}$ , Half sine pulse	32	A
$I^2t$	$\int I^2 dt$	$T_C = 25\text{ °C}$ , $t_p = 10\text{ ms}$ , Half sine pulse	5	A <sup>2</sup> s
Power Dissipation	$P_{Tot}$	$T_C = 25\text{ °C}$	75	W
		$T_C = 110\text{ °C}$	32	
Operating Junction Temperature	$T_J$	-	-55 to 175	°C
Storage Temperature	$T_{STG}$	-	-55 to 150	°C
Lead Temperature for Soldering (MSL 1 rated)	$T_{SOLD}$	-	260	°C

## 2. Thermal Characteristics

Characteristic	Symbol	Value	Unit
Maximum Thermal Resistance	$R_{thJC, max}$	2.0	°C/W

## 3. Electrical Characteristics

Characteristic	Symbol	Conditions	Value			Unit
			Min	Typ	Max	
Forward Voltage	$V_F$	$I_F = 6\text{ A}$ , $T_J = 25\text{ °C}$	-	1.5	1.8	V
		$I_F = 6\text{ A}$ , $T_J = 175\text{ °C}$	-	1.9	-	
Reverse Current	$I_R$	$V_R = 650\text{ V}$ , $T_J = 25\text{ °C}$	-	<1	100	μA
		$V_R = 650\text{ V}$ , $T_J = 175\text{ °C}$	-	13	-	
Capacitance	C	$V_R = 1\text{ V}$ , $f = 1\text{ MHz}$	-	300	-	pF
		$V_R = 200\text{ V}$ , $f = 1\text{ MHz}$	-	39	-	
		$V_R = 400\text{ V}$ , $f = 1\text{ MHz}$	-	28	-	
Total Capacitive Charge	$Q_C$	$V_R = 400\text{ V}$ , $Q_C = \int C(V) dV$	-	20	-	nC
Capacitance Stored Energy	$E_C$	$V_R = 400\text{ V}$	-	2.2	-	μJ

### 4. Performance Curves

Figure 1. Typical Forward Characteristics

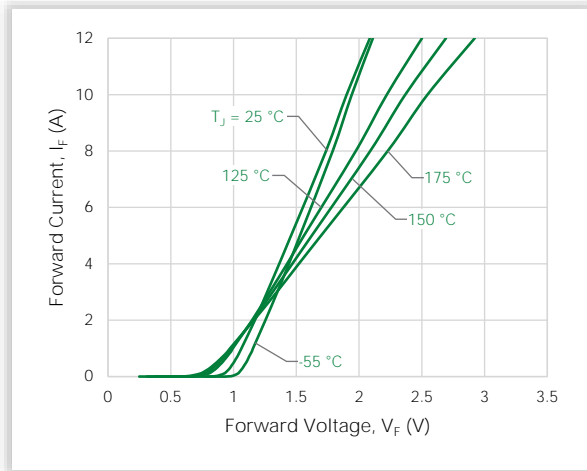

Figure 2. Typical Reverse Characteristics

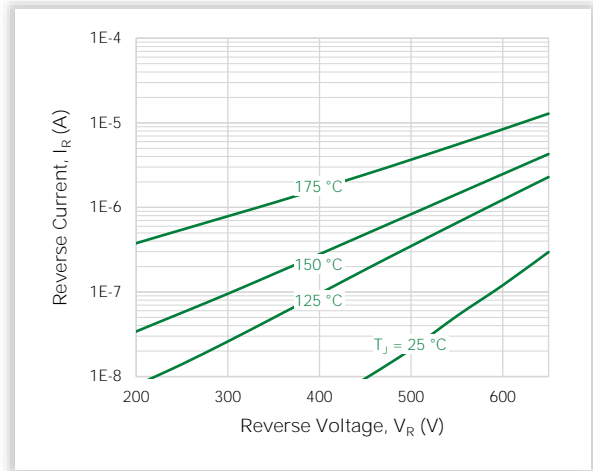

Figure 3. Power Derating

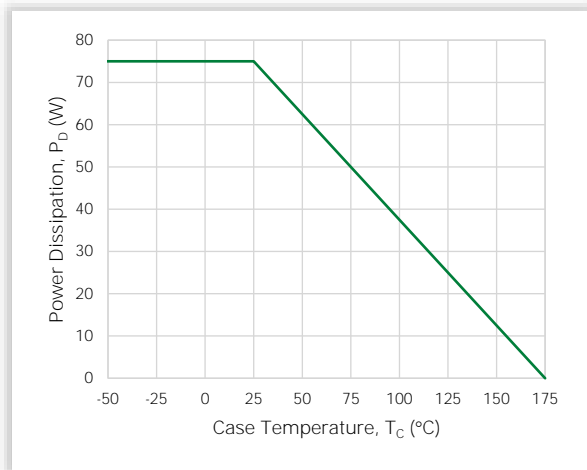

Figure 4. Current Derating

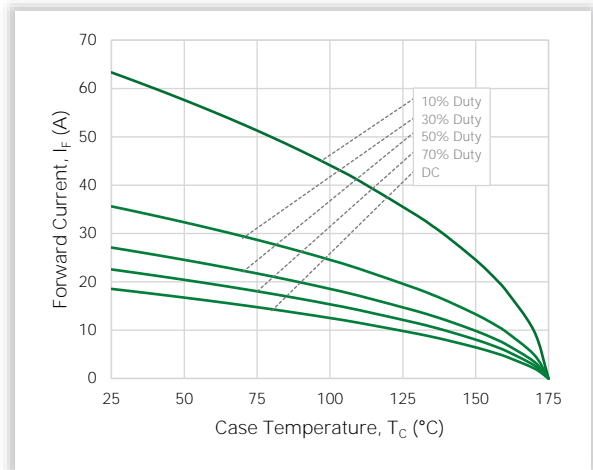

Figure 5. Capacitance vs. Reverse Voltage

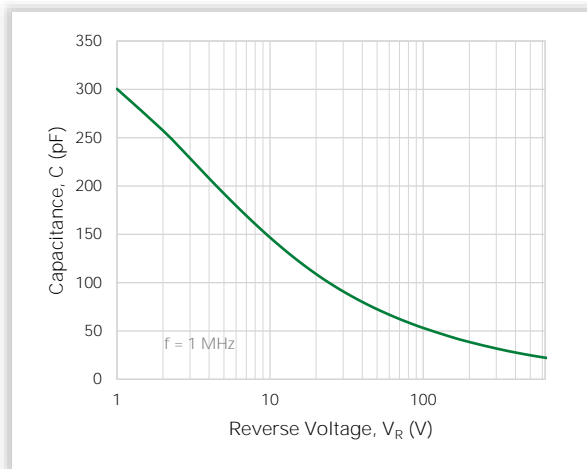

Figure 6. Capacitive Charge vs. Reverse Voltage

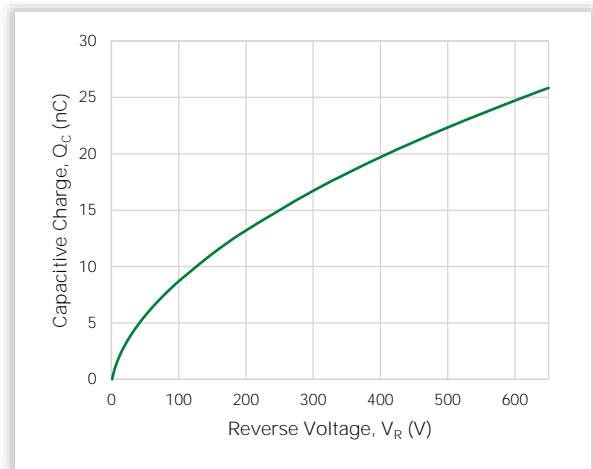

Figure 7. Stored Energy vs. Reverse Voltage

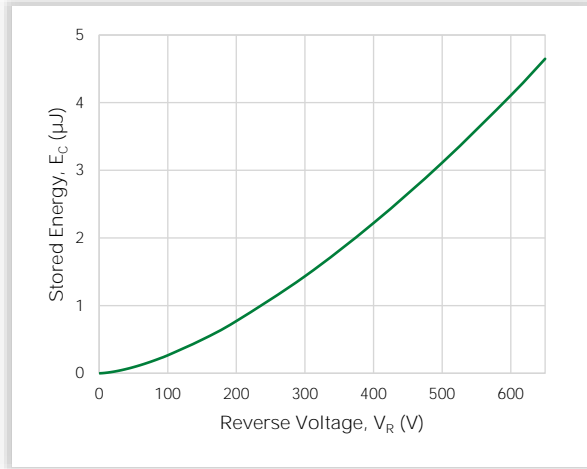
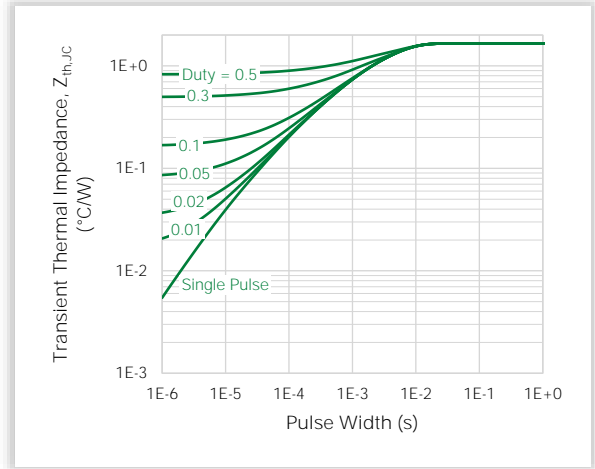
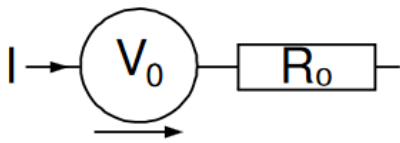

Figure 8. Transient Thermal Impedance



### 5. $V_F$ Model for Simulations



$$V_F(T_J) = V_0 + IR_0$$

$$V_0 = -1.22 \times 10^{-3} \cdot T_J + 1.04 \times 10^0$$

$$R_0 = 2.36 \times 10^{-6} \cdot T_J^2 + 8.79 \times 10^{-5} \cdot T_J + 8.62 \times 10^{-2}$$

Notes:

- $T_J$  is junction temperature in  $^{\circ}\text{C}$
- Range valid from  $25\text{ }^{\circ}\text{C}$  to  $175\text{ }^{\circ}\text{C}$
- Model represents performance of a typical part

6. Package Dimensions

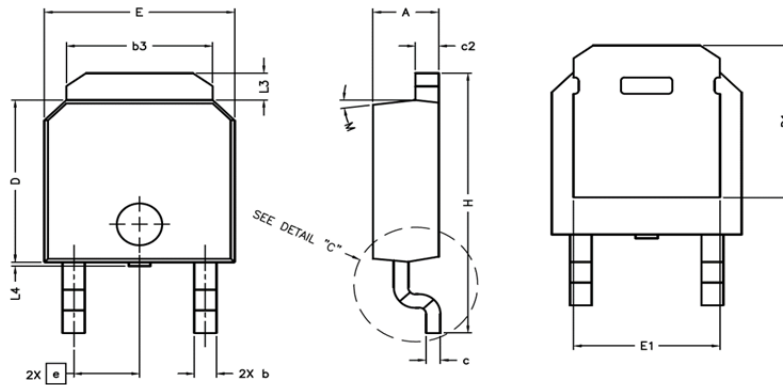

- NOTE:
1. L4 – MAXIMUM PLASTIC PROTRUSION.
  2. L2 – REFERENCE FOR FOOT LENGTH MEASUREMENT.
  3. THERMAL PAD CONTOUR OPTIONAL WITHIN DIMENSIONS B3, L3, D1, AND E1
  4. PACKAGE OUTLINE D AND E EXCLUSIVE OF ANY MOLD FLASHES DIMENSIONS.
  5. PACKAGE OUTLINE D AND E EXCLUSIVE OF ANY BURR DIMENSIONS.
  6. FOR SINGLE-GAUGE LEADFRAME.

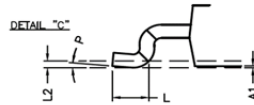

Symbol	Millimeters	
	Min	Max
A	2.159	2.413
A1	-	0.127
b	0.635	1.067
b3	4.953	5.461
c	0.457	0.610
c2	-	0.889
(c2)	0.457	0.610
D	5.969	6.223
D1	5.207	5.715
E	6.350	6.731
E1	4.318	5.207
e	2.29 REF.	
H	9.398	10.414
L	1.016	1.778
L2	0.25 REF.	
L3	0.889	1.270
L4	0.000	0.152
M	15°	
P	-	5°

Recommended Solder Pattern Layout

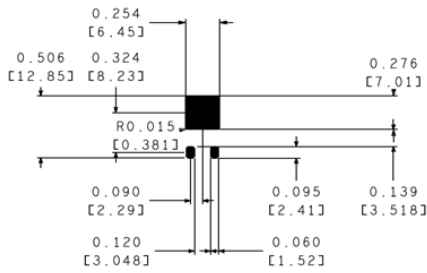

UNIT: Inch [mm]

### 7. Part Numbering and Marking

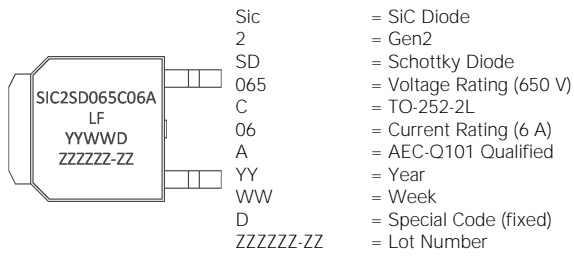

### 8. Packing Options

Part Number	Marking	Packing Mode	M.O.Q.
LSIC2SD065C06A	SIC2SD065C06A	Tape and Reel	2500

### 9. Packing Specifications

Carrier Tape and Reel Specification TO-252-2L

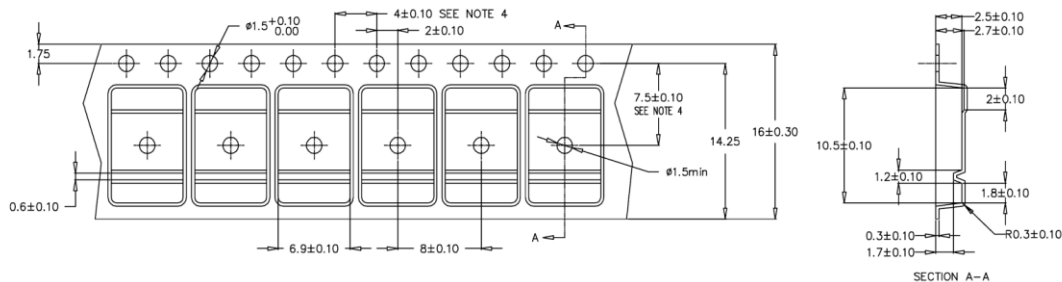

1. Material: Black Conductive Polyesterene
2. 10 sprocket hole pitch cumulative tolerance  $\pm 0.20$
3. Camber not to exceed 1 mm in 100 mm.
4. Pocket position relative to sprocket hole measured as true position of pocket, not pocket hole.
5. Device orientation: TRL (leads perpendicular to the sprocket)
6. General tolerance is  $\pm 0.10$  mm unless otherwise specified.

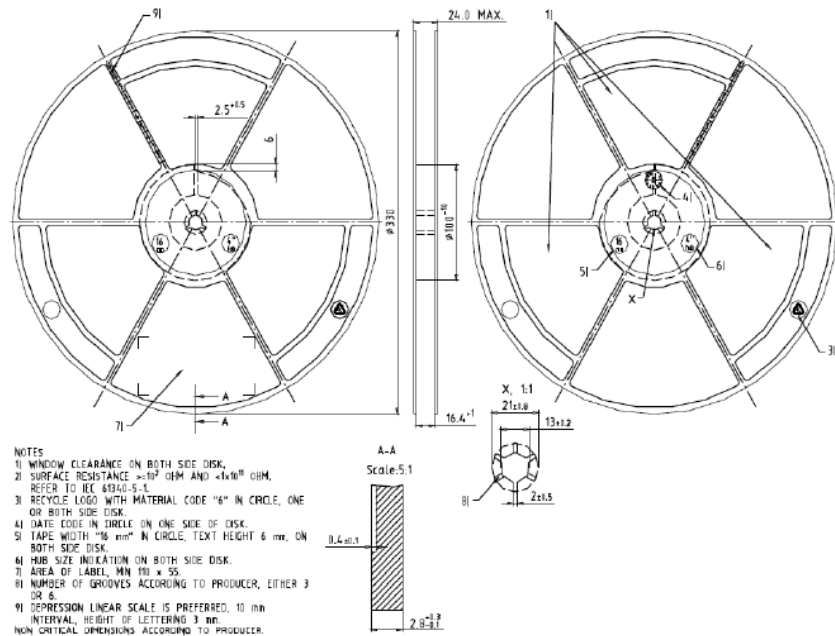

- NOTES
- 1) WINDOW CLEARANCE ON BOTH SIDE DISK.
  - 2) SURFACE RESISTANCE  $>10^7$  OHM AND  $<1 \times 10^{10}$  OHM. REFER TO IEC 61940-5-1.
  - 3) RECYCLE LOGO WITH MATERIAL CODE "6" IN CIRCLE, ONE ON BOTH SIDE DISK.
  - 4) DATE CODE IN CIRCLE ON ONE SIDE OF DISK.
  - 5) TAPE WIDTH "16 mm" IN CIRCLE, TEXT HEIGHT 6 mm, ON BOTH SIDE DISK.
  - 6) HUB SIZE INDICATION ON BOTH SIDE DISK.
  - 7) AREA OF LABEL, MIN 100 x 55.
  - 8) NUMBER OF GROOVES ACCORDING TO PRODUCER, EITHER 3 OR 6.
  - 9) DEPRESSION LINEAR SCALE IS PREFERRED, 10 mm INTERVAL, HEIGHT OF LETTERING 3 mm. NON CRITICAL DIMENSIONS ACCORDING TO PRODUCER.

For additional information please visit [www.Littelfuse.com/powersemi](http://www.Littelfuse.com/powersemi)

Disclaimer Notice - Littelfuse products are not designed for, and shall not be used for, any purpose (including, without limitation, automotive, military, aerospace, medical, life-saving, life-sustaining or nuclear facility applications, devices intended for surgical implant into the body, or any other application in which the failure or lack of desired operation of the product may result in personal injury, death, or property damage) other than those expressly forth in applicable Littelfuse product documentation. Littelfuse shall not be liable for any claims or damages arising out of products used in applications not expressly intended by Littelfuse as set forth in applicable Littelfuse documentation.

Read complete Disclaimer Notice at [www.littelfuse.com/disclaimer-electronics](http://www.littelfuse.com/disclaimer-electronics)