

DST2050S

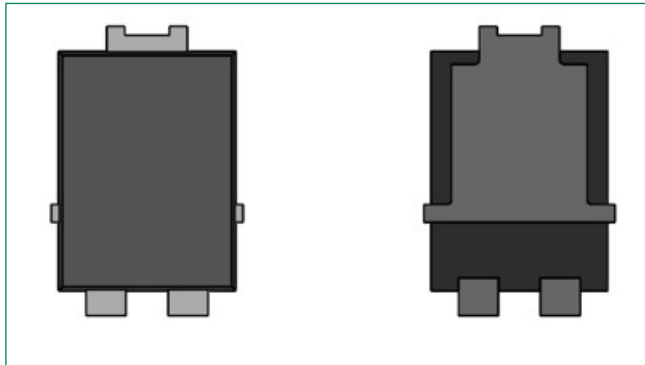

Pin out

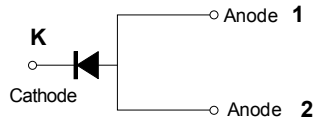

Description

Littelfuse DST series Ultra Low V_F Schottky Barrier Rectifier is designed to meet the general requirements of commercial and industry applications by providing high temperature, low leakage and lower V_F products.

It is suitable for high frequency switching mode power supply, free-wheeling diodes and polarity protection diodes.

Features

- Ultra low forward voltage drop
- High frequency operation
- MSL: Level 1 - unlimited
- High junction temperature capability
- Trench MOS Schottky technology
- Single die in TO-277B Package
- Pb-free E3 means 2nd level interconnect is Pb-free and the terminal finish material is tin(Sn) (IPC/ JEDEC J-STD-609A.01)

Applications

- Switching mode power supply
- DC/DC converters
- Free-Wheeling diodes
- Polarity Protection Diodes

Maximum Ratings

Parameters	Symbol	Test Conditions	Max	Unit
Peak Inverse Voltage	V_{RWM}	-	50	V
Average Forward Current	$I_{F(AV)}$	50% duty cycle @ $T_L = 125^\circ\text{C}$ rectangular wave form	20	A
Peak One Cycle Non-Repetitive Surge Current	I_{FSM}	8.3 ms, half Sine pulse	250	A

Electrical Characteristics

Parameters	Symbol	Test Conditions	Max	Unit
Forward Voltage Drop*	V_{F1}	@20A, Pulse, $T_J = 25^\circ\text{C}$	0.65	V
	V_{F2}	@20A, Pulse, $T_J = 125^\circ\text{C}$	0.60	
Reverse Current*	I_{R1}	@ $V_R = \text{rated } V_R, T_J = 25^\circ\text{C}$	4	mA
	I_{R2}	@ $V_R = \text{rated } V_R, T_J = 125^\circ\text{C}$	180	

* Pulse Width < 300 μs , Duty Cycle < 2%

Thermal-Mechanical Specifications

Parameters	Symbol	Test Conditions	Max	Unit
Junction Temperature	T_J		-55 to +150	°C
Storage Temperature	T_{stg}		-55 to +150	°C
Maximum Thermal Resistance Junction to Ambient	R_{thJA}	DC operation	75	°C/W
Maximum Thermal Resistance Junction to Lead	R_{thJL}		3.5	°C/W
Approximate Weight	wt		0.08	g
Case Style	TO-277B			

Figure 1: Typical Forward Characteristics

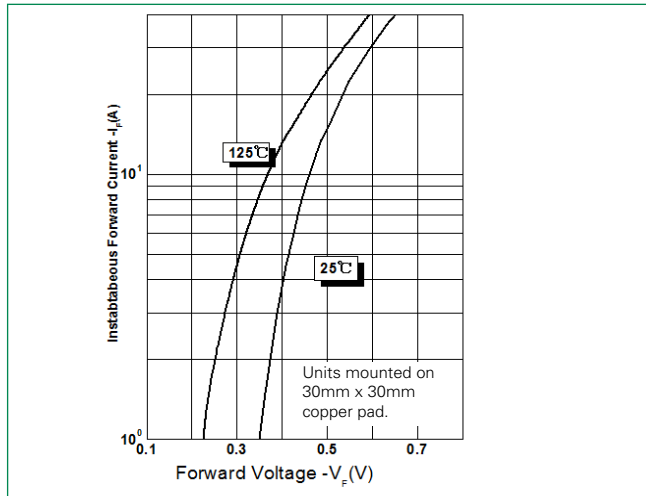

Figure 2: Typical Reverse Characteristics

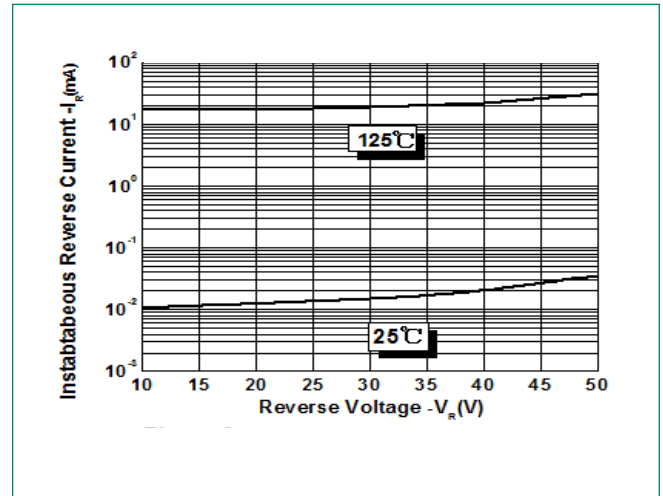
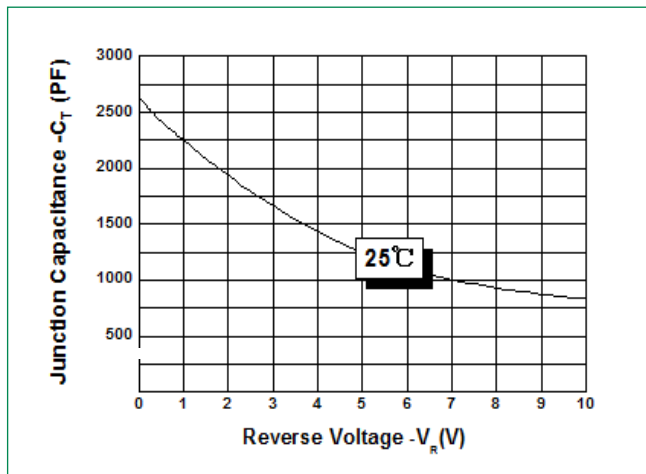
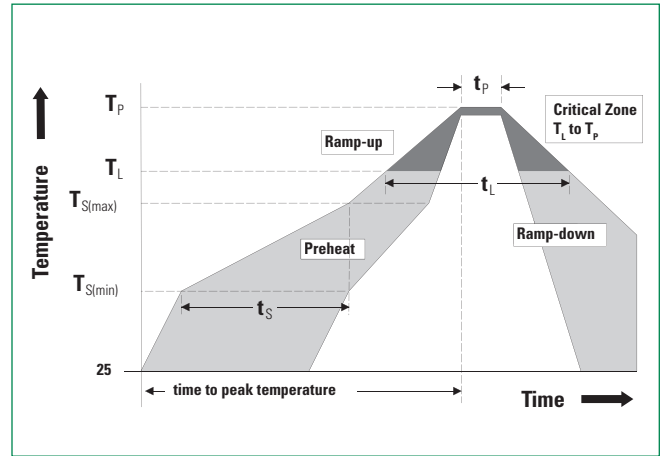

Figure 3: Typical Junction Capacitance



Soldering Parameters

Reflow Condition	Lead-Free assembly	
Pre Heat	- Temperature Min ($T_{s(min)}$)	150°C
	- Temperature Max ($T_{s(max)}$)	200°C
	- Time (min to max) (t_s)	60 – 120 seconds
Average ramp up rate (Liquidus Temp) (T_L) to peak	3°C/second max.	
$T_{s(max)}$ to T_L - Ramp-up Rate	3°C/second max.	
Reflow	- Temperature (T_L) (Liquidus)	217°C
	- Time (min to max) (t_s)	60 – 150 seconds
Peak Temperature (T_p)	260 ^{+0/-5} °C	
Time within 5°C of actual peak Temperature (t_p)	30 seconds max.	
Ramp-down Rate	6°C/second max.	
Time 25°C to peak Temperature (T_p)	8 minutes max.	
Do not exceed	260°C	



Dimensions-TO-277B

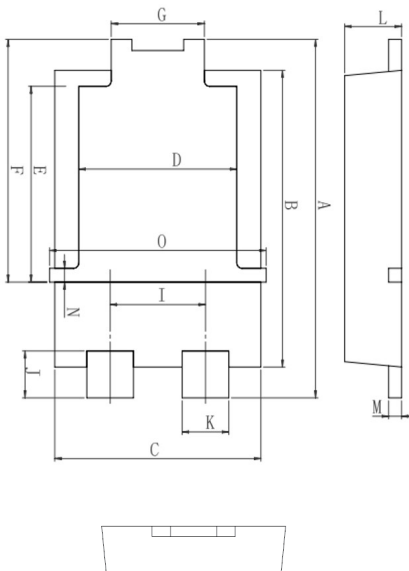

Symbol	Millimeters		
	Min	Typ	Max
A	6.30	6.50	6.70
B	5.28	5.38	5.48
C	3.88	3.98	4.08
D	2.90	3.05	3.20
E	3.40	3.55	3.70
F	4.20	4.40	4.60
G	1.70	1.80	1.90
I	1.74	1.84	1.94
J	0.65	0.85	1.05
K	0.85	0.90	0.95
L	0.95	1.10	1.25
M	0.20	0.25	0.30
N	0.25	0.40	0.55
O	4.00	4.05	4.25

Mounting Pad Layout

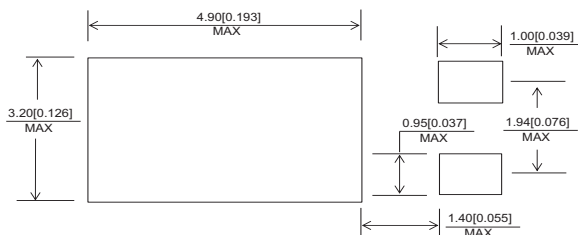

Packing Options

Part Number	Marking	Packing Mode	M.O.Q
DST2050S	DST2050S	5000pcs / Reel	5000

Part Numbering and Marking System



DST = Device Type
 20 = Forward Current (20A)
 50 = Reverse Voltage (50V)
 S = Package Type
 LF = Littelfuse
 YY = Year
 WW = Week
 L = Lot Number

Carrier Tape & Reel Specification

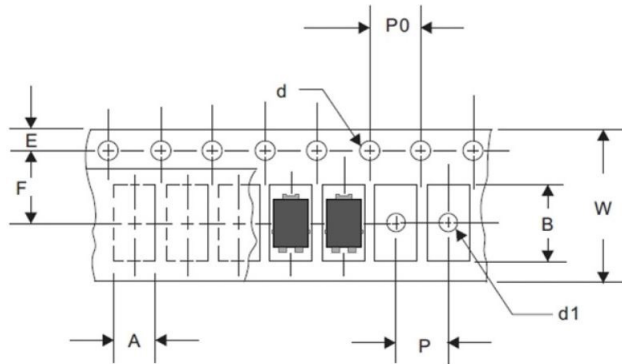

Symbol	Millimeters	
	Min	Max
A	4.28	4.48
B	6.80	7.00
d	1.40	1.60
d1	-	1.50
E	1.65	1.85
F	5.40	5.60
P	7.90	8.10
P0	3.90	4.10
W	11.70	12.30

Disclaimer Notice - Information furnished is believed to be accurate and reliable. However, users should independently evaluate the suitability of and test each product selected for their own applications. Littelfuse products are not designed for, and may not be used in, all applications. Read complete Disclaimer Notice at <http://www.littelfuse.com/disclaimer-electronics>.