

### DST1050S-A

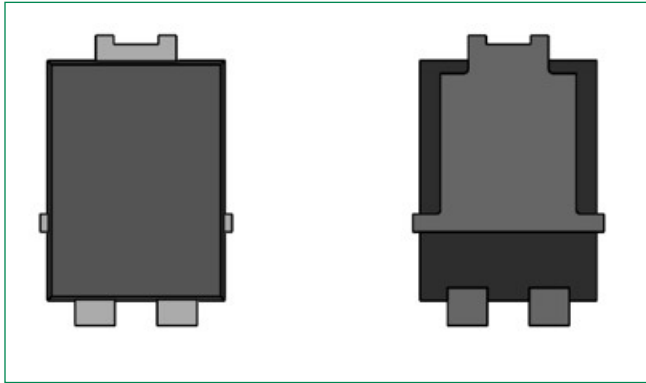

#### Pin out

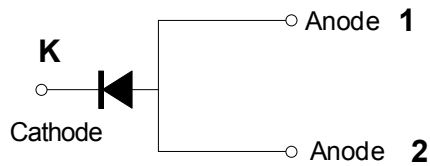

#### Description

Littelfuse DST series Ultra Low  $V_F$  Schottky Barrier Rectifier is designed to meet the general requirements of automotive applications by providing high temperature, low leakage and lower  $V_F$  products.

It is suitable for high frequency switching mode power supply, free-wheeling diodes and polarity protection diodes.

#### Features

- High reliability application and AEC-Q101 qualified
- Ultra low forward voltage drop
- High frequency operation
- MSL: Level 1 - unlimited
- High junction temperature capability
- Trench MOS Schottky technology
- Single die in TO-277B Package
- Pb-free E3 means 2nd level interconnect is Pb-free and the terminal finish material is tin(Sn) (IPC/ JEDEC J-STD-609A.01)

#### Applications

- Switching mode power supply
- DC/DC converters
- Free-Wheeling diodes
- Polarity Protection Diodes

#### Maximum Ratings

Parameters	Symbol	Test Conditions	Max	Unit
Peak Inverse Voltage	$V_{RWM}$	-	50	V
Average Forward Current	$I_{F(AV)}$	50% duty cycle @ $T_L = 125^\circ\text{C}$ rectangular wave form	10	A
Peak One Cycle Non-Repetitive Surge Current	$I_{FSM}$	8.3 ms, half Sine pulse	150	A

#### Electrical Characteristics

Parameters	Symbol	Test Conditions	Typ	Max	Unit
Forward Voltage Drop*	$V_{F1}$	@5A, Pulse, $T_J = 25^\circ\text{C}$	0.40	0.48	V
		@10A, Pulse, $T_J = 25^\circ\text{C}$	0.47	0.55	
	$V_{F2}$	@5A, Pulse, $T_J = 125^\circ\text{C}$	0.30	0.39	
		@10A, Pulse, $T_J = 125^\circ\text{C}$	0.40	0.49	
Reverse Current*	$I_{R1}$	@ $V_R = \text{rated } V_R, T_J = 25^\circ\text{C}$	0.05	1.5	mA
	$I_{R2}$	@ $V_R = \text{rated } V_R, T_J = 125^\circ\text{C}$	32	85	

\* Pulse Width < 300 $\mu\text{s}$ , Duty Cycle < 2%

**Thermal-Mechanical Specifications**

Parameters	Symbol	Test Conditions	Max	Unit
Junction Temperature	$T_J$		-55 to +150	°C
Storage Temperature	$T_{stg}$		-55 to +150	°C
Maximum Thermal Resistance Junction to Ambient	$R_{thJA}$	DC operation	75	°C/W
Maximum Thermal Resistance Junction to Lead	$R_{thJL}$		3.5	°C/W
Approximate Weight	wt		0.08	g
Case Style		TO-277B		

**Figure 1: Typical Forward Characteristics**

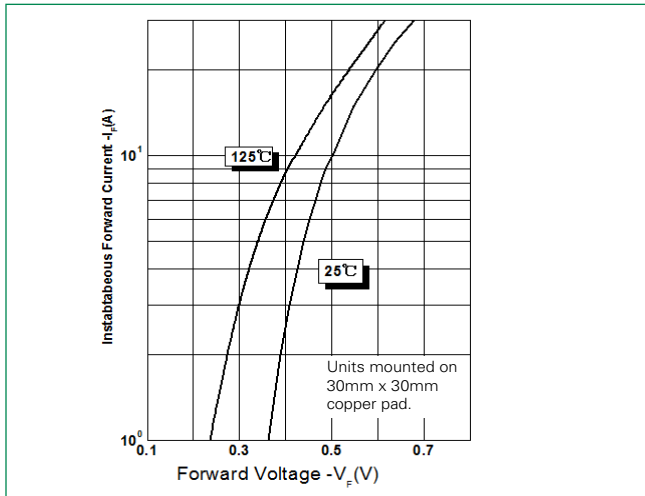

**Figure 2: Typical Reverse Characteristics**

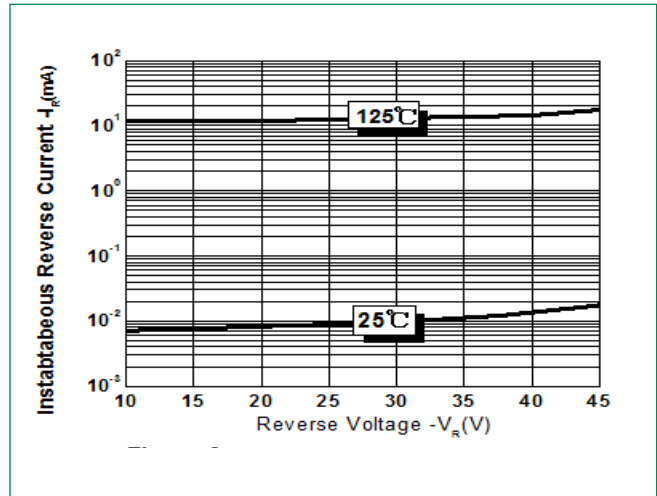

**Figure 3: Typical Junction Capacitance**

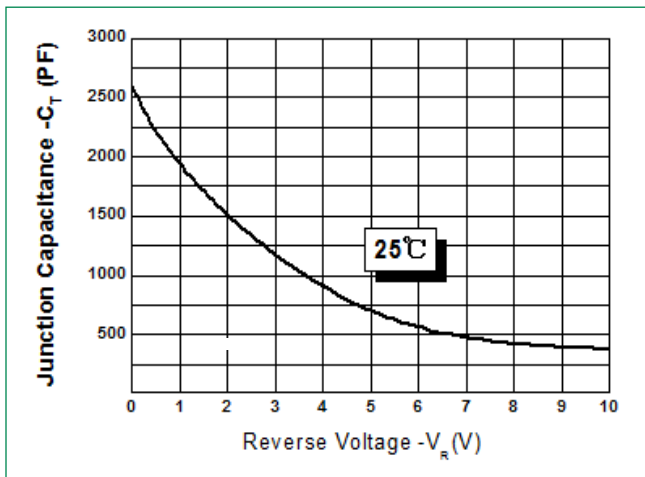

### Dimensions-TO-277B

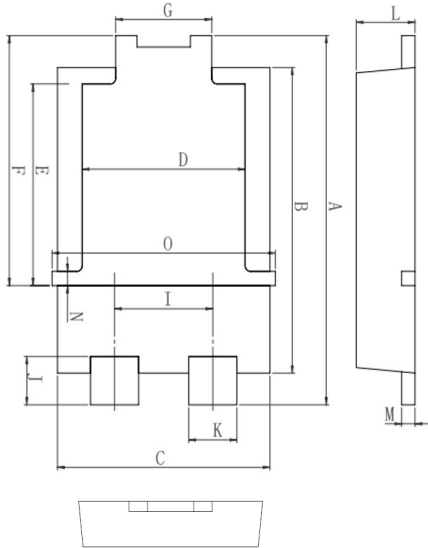

Mounting Pad Layout

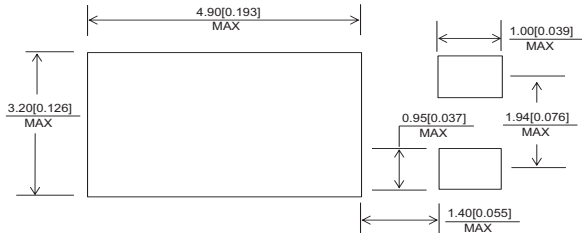

Symbol	Millimeters		
	Min	Typ	Max
A	6.30	6.50	6.70
B	5.28	5.38	5.48
C	3.88	3.98	4.08
D	2.90	3.05	3.20
E	3.40	3.55	3.70
F	4.20	4.40	4.60
G	1.70	1.80	1.90
I	1.74	1.84	1.94
J	0.65	0.85	1.05
K	0.85	0.90	0.95
L	0.95	1.10	1.25
M	0.20	0.25	0.30
N	0.25	0.40	0.55
O	4.00	4.05	4.25

### Part Numbering and Marking System

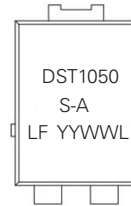

- DST = Device Type
- 10 = Forward Current (10A)
- 50 = Reverse Voltage (50V)
- S = Package Type
- A = AEC-Q101 qualified device
- LF = Littelfuse
- YY = Year
- WW = Week
- L = Lot Number

### Packing Options

Part Number	Marking	Packing Mode	M.O.Q
DST1050S-A	DST1050S-A	5000pcs / Reel	5000

### Carrier Tape & Reel Specification

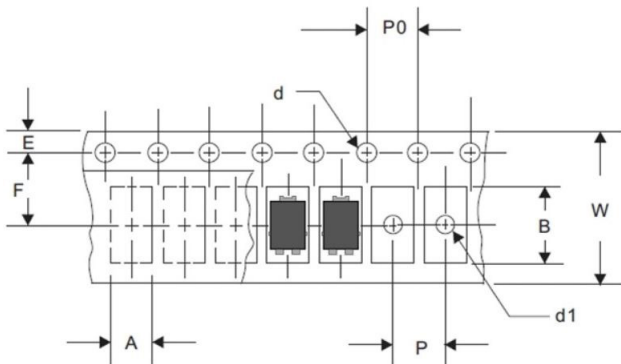

Symbol	Millimeters	
	Min	Max
A	4.28	4.48
B	6.80	7.00
d	1.40	1.60
d1	-	1.50
E	1.65	1.85
F	5.40	5.60
P	7.90	8.10
P0	3.90	4.10
W	11.70	12.30