

Rectifier Module Circuit Series- Package A



Agency Approvals

AGENCY	AGENCY FILE NUMBER
	E71639

Circuit Diagram

B type

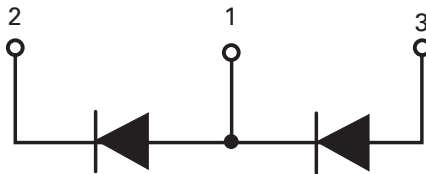

DK type

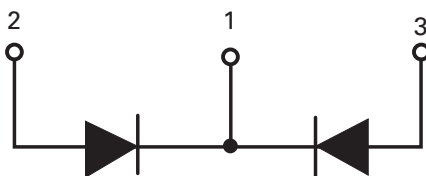

Features

- Low reverse recovery loss
- Low forward voltage
- High surge current capability
- Low inductance package

Applications

- Field supply for DC motors
- Line rectifiers for transistorized AC motor controllers
- Non-controllable rectifiers for AC/DC converter

Main Features

Symbol	Value	Unit
$I_{F(AV)}$	90 to 110	A
V_{RRM}	1600 to 1800	V
V_{RSM}	1700 to 1900	V

Absolute Maximum Rating ($T_c = 25^\circ\text{C}$, unless otherwise specified)

Symbol	Parameters		Value	Unit
V_{RRM}	Repetitive Peak Reverse Voltage	MD16xxxA	1600	V
		MD18xxxA	1800	
V_{RSM}	Non-Repetitive Peak Reverse Voltage	MD16xxxA	1700	V
		MD18xxxA	1900	

Absolute Maximum Ratings ($T_c = 25^\circ\text{C}$, unless otherwise specified)

Symbol	Parameters	Test Conditions	Values		Unit
			MDxx90A	MDxx110A	
$I_{F(AV)}$	Average Forward Current	Single phase, half wave 180°C conduction, $T_c=85^\circ\text{C}$	90	110	A
$I_{F(RMS)}$	RMS Forward Current		141	170	A
I_{FSM}	Non-Repetitive Surge Forward Current	$T_c=45^\circ\text{C}$, 50Hz, Single wave	2000	2500	A
		$T_c=45^\circ\text{C}$, 60Hz, Single wave	2200	2700	
I^2t	I^2t (For Fusing)	$T_c=45^\circ\text{C}$, 50Hz, Single wave	20.0	31.2	KA ² s
		$T_c=45^\circ\text{C}$, 60Hz, Single wave	20.1	30.2	
P_D	Power Dissipation		310	410	W
T_J	Junction Temperature		-40 to +150		$^\circ\text{C}$
T_{STG}	Storage Temperature Range		-40 to +125		$^\circ\text{C}$
V_{ISOL}	Insulation Test Voltage	AC, 50Hz, t=1min	3000		V

Electrical and Thermal Specifications ($T_c = 25^\circ\text{C}$, unless otherwise specified)

Symbol	Parameters	Test Conditions	Min	Typ	Max	Unit
I_{RM}	Reverse Leakage Current	$V_R=V_{RRM}$	-	-	500	μA
		$V_R=V_{RRM}, T_J=125^\circ\text{C}$	-	-	10	mA
V_F	Forward Voltage	MDxx90A $I_F=280\text{A}$	-	-	1.6	V
		MDxx110A $I_F=350\text{A}$	-	-	1.6	
V_{TO}	For power-loss calculations only $T_J=125^\circ\text{C}$	MDxx90A	-	-	0.85	V
		MDxx110A	-	-	0.8	
r_T		MDxx90A	-	-	2.9	m Ω
		MDxx110A	-	-	2.4	

Mechanical Characteristics

Symbol	Parameters	Test Conditions	Min	Typ	Max	Unit
Torque	Module-to-Sink	Recommended (M6)	3		5	N·m
Torque	Module Electrodes	Recommended (M6)	2.5		5	N·m

Electrical and Thermal Specifications ($T_c = 25^\circ\text{C}$, unless otherwise specified)

Symbol	Parameters	Test Conditions	Max	Unit
R_{thJC}	Junction-to-Case	MDxx90A	0.4	K/W
		MDxx110A	0.3	

Figure 1: Forward current vs.voltage drop

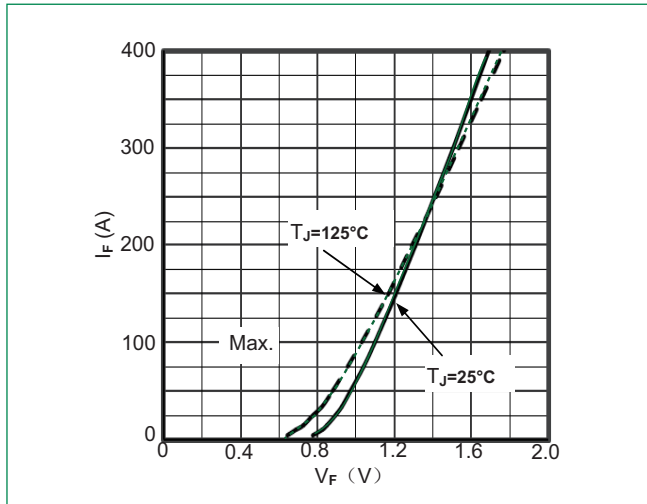

Figure 2: Max Non-Repetitive Forward Surge Current

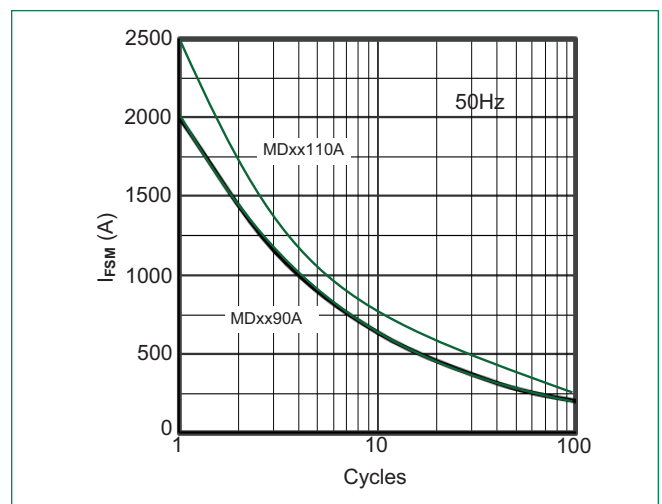

Figure 3: Forward current vs.Case temperature

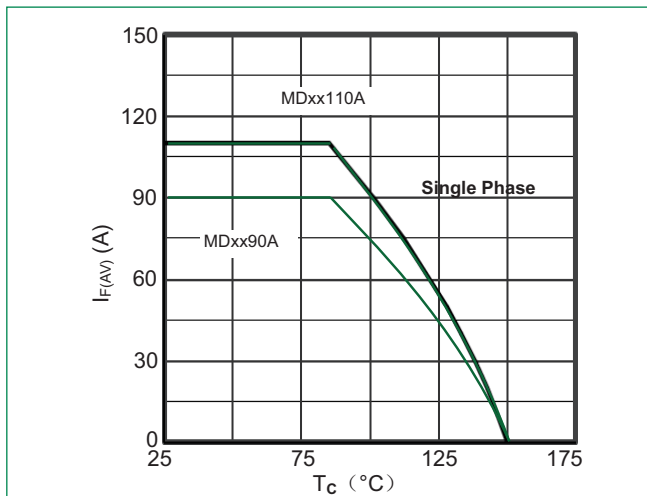

Figure 4: Transient Thermal Impedance

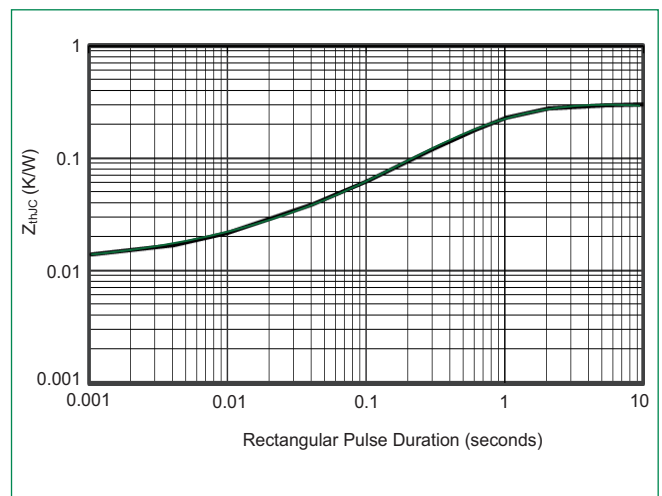

Figure 5: Power dissipation vs. $I_{F(AV)}$ for MDxx90A

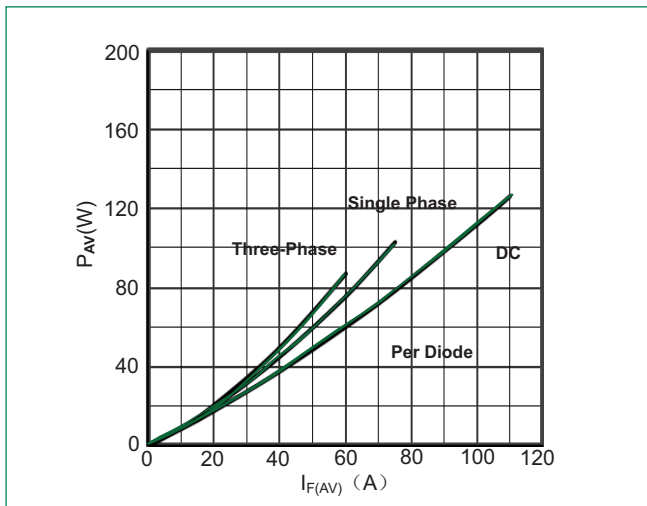
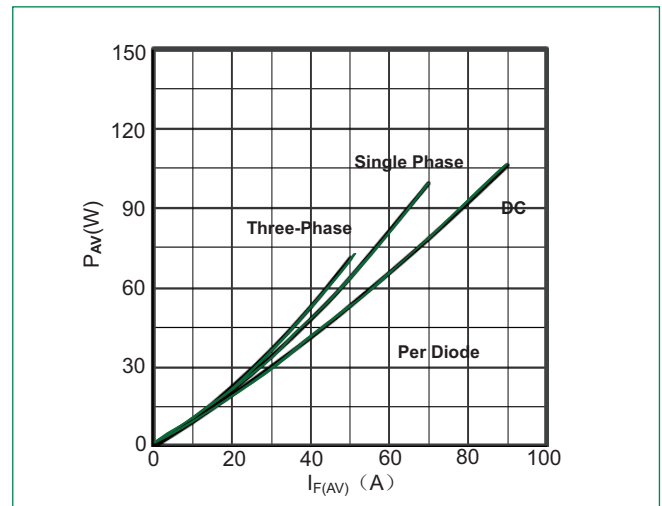
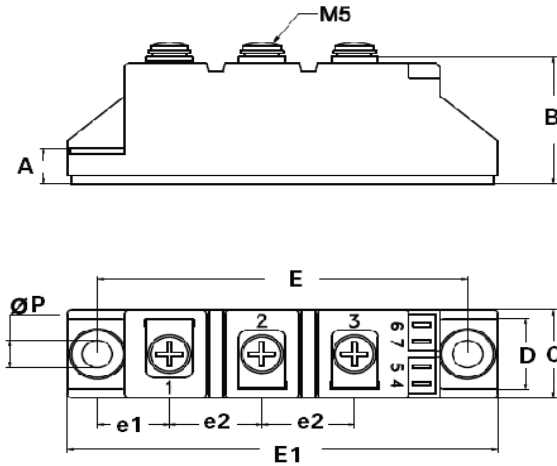

Figure 5: Power dissipation vs. $I_{F(AV)}$ for MDxx110A



Dimensions-Package A



Dimension	Inches		Millimeters	
	Max	Max	Min	Max
A	0.315	0.354	8.0	9.0
B	1.177	1.217	29.9	30.9
C	0.807	0.846	20.5	21.5
D	0.650	0.689	16.5	17.5
E	3.110	3.189	79.0	81.0
E1	3.622	3.700	92.0	94.0
e1	0.594	0.634	15.1	16.1
e2	0.768	0.807	19.5	20.5
P	0.236	0.276	6.0	7.0

Packing Selector

Part Number	V_{RRM}		$I_{F(AV)}$	Circuit Type	Package
	1600V	1800V			
MDxx90A-BM2MM	X	X	90A	B	A
MDxx90A-DKM2MM	X	X		DK	
MDxx110A-BM2MM	X	X	110A	B	
MDxx110A-DKM2MM	X	X		DK	

Packing Options

Part Number	Marking	Weight	Packing Mode	M.O.Q.
MDxxxxxA-xM2MM	MDxxxxxA-xM2MM	110g	Bulk Pack	70

Part Numbering System

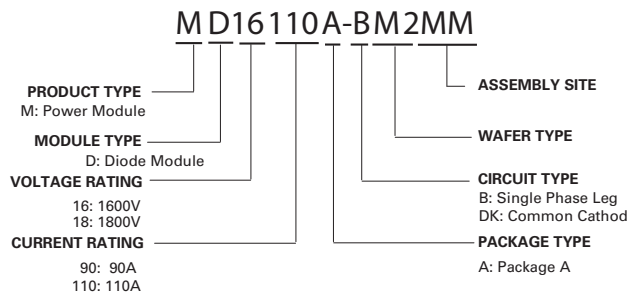

Part Marking System

