

Specification Status: Released



GENERAL DESCRIPTION

Littelfuse PolyZen devices are polymer enhanced, precision Zener diode micro-assemblies. They offer resettable protection against multi-Watt fault events without the need for multi-Watt heat sinks.

The Zener diode used for voltage clamping in a PolyZen micro-assembly

was selected due to its relatively flat voltage vs current response. This helps improve output voltage clamping, even when input voltage is high and diode currents are large.

An advanced feature of the PolyZen micro-assembly is that the Zener diode is thermally coupled to a resistively non-linear, polymer PTC (positive temperature coefficient) layer. This PTC layer is fully integrated into the device, and is electrically in series between V_{IN} and the diode clamped V_{OUT} .

This advanced PTC layer responds to either extended diode heating or overcurrent events by transitioning from a low to high resistance state, also known as "tripping". A tripped PTC will limit current and generate voltage drop. It helps to protect both the Zener diode and the follow on electronics and effectively increases the diode's power handling capability.

The polymer enhanced Zener diode helps protect sensitive portable electronics from damage caused by inductive voltage spikes, voltage transients, incorrect power supplies and reverse bias. These devices are particularly suitable for portable electronics and other low-power DC devices.

BENEFITS

- Stable Zener diode helps shield downstream electronics from overvoltage and reverse bias
- Trip events shut out overvoltage and reverse bias sources
- Analog nature of trip events minimizes upstream inductive spikes
- Minimal power dissipation requirements
- Single component placement

FEATURES

- Overvoltage transient suppression
- Stable V_Z vs fault current
- Time delayed, overvoltage trip
- Time delayed, reverse bias trip
- Multi-Watt power handling capability
- Integrated device construction
- RoHS Compliant

TARGET APPLICATIONS

- DC power port protection in portable electronics
- DC power port protection for systems using barrel jacks for power input
- Internal overvoltage & transient suppression
- DC output voltage regulation

TYPICAL APPLICATION BLOCK DIAGRAM

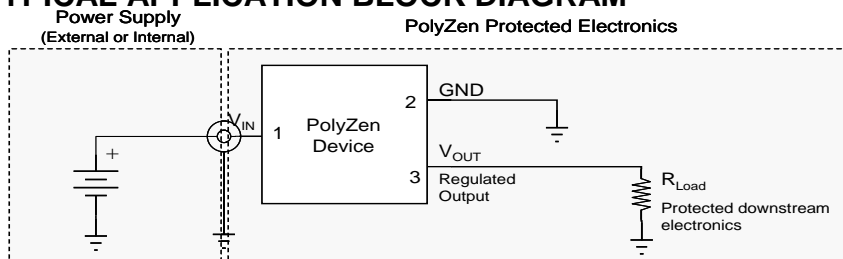

CONFIGURATION INFORMATION

Pin Configuration (Top View)

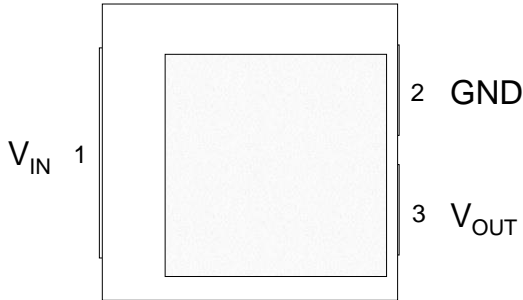

Recommended Pad Dimensions

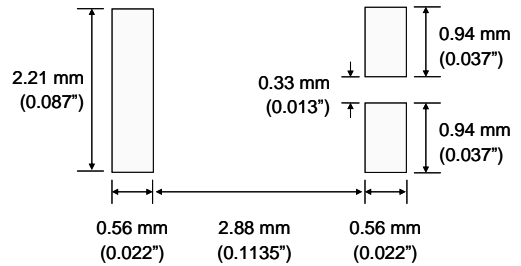

PIN DESCRIPTION

Pin Number	Pin Name	Pin Function
1	V_{IN}	V_{IN} . Protected input to Zener diode.
2	GND	GND
3	V_{OUT}	V_{OUT} . Zener regulated voltage output

BLOCK DIAGRAM

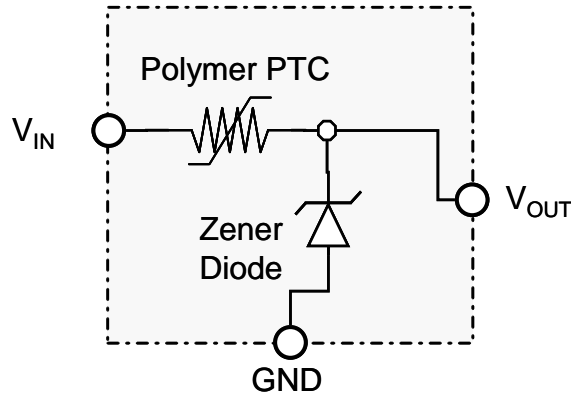

DEFINITION of TERMS

I_{PTC}	Current flowing through the PTC portion of the circuit
I_{FLT}	RMS fault current flowing through the diode
I_{OUT}	Current flowing out the V_{OUT} pin of the device
Trip Event	A condition where the PTC transitions to a high resistance state, thereby significantly limiting I_{PTC} and related currents, and significantly increasing the voltage drop between V_{IN} and V_{OUT} .
Trip Endurance	Time the PTC portion of the device remains both powered and in a tripped state.

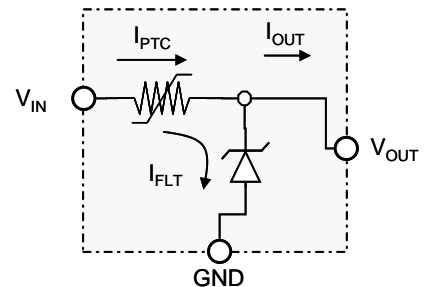

GENERAL SPECIFICATIONS

Operating Temperature -40° to +85°C
Storage Temperature -40° to +85°C

ELECTRICAL CHARACTERISTICS^{1-3, 11} (Typical unless otherwise specified)

V _Z ⁴ (V)			I _{ZT} ⁴ (A)	I _{HOLD} ⁵ @20°C (A)	Leakage Current		R Typ ⁶ (Ohms)	R _{1Max} ⁷ (Ohms)	V _{INT} Max ⁸ (V)		I _{FLT} Max ⁹		Tripped Power Dissipation ¹⁰ Max	
Min	Typ	Max			Test Voltage	Max Current (mA)			V _{INT} Max (V)	Test Current (A)	I _{FLT} Max (A)	Test Voltage (V)	Value (W)	Test Voltage (V)
5.45	5.6	5.75	0.1	1.15	5.25	10	0.15	0.18	24V	3A	+10 -40	+24 -16V	1.0	24

- Note 1: Electrical characteristics determined at 25°C unless otherwise specified.
- Note 2: This device is intended for limited fault protection. Repeated trip events or extended trip endurance can degrade the device and may affect performance to specifications. Performance impact will depend on multiple factors including, but not limited to, voltage, trip current, trip duration, trip cycles, and circuit design. For details or ratings specific to your application contact Littelfuse Circuit Protection directly.
- Note 3: Specifications developed using 1.0 ounce 0.045" wide copper traces on dedicated FR4 test boards. Performance in your application may vary.
- Note 4: I_{ZT} is the current at which V_Z is measured (V_Z = V_{OUT}). Additional V_Z values are available on request.
- Note 5: I_{HOLD}: Maximum steady state I_{PTC} (current entering or exiting the V_{IN} pin of the device) that will not generate a trip event at the specified temperature. Specification assumes I_{FLT} (current flowing through the Zener diode) is sufficiently low so as to prevent the diode from acting as a heat source. Testing is conducted with an "open" Zener.
- Note 6: R Typ: Resistance between V_{IN} and V_{OUT} pins during normal operation at room temperature.
- Note 7: R_{1Max}: The maximum resistance between V_{IN} and V_{OUT} pins at room temperature, one hour after 1st trip or after reflow soldering.
- Note 8: V_{INT} Max: V_{INT} Max relates to the voltage across the PPTC portion of the PolyZen device (V_{IN}-V_{OUT}). V_{INT} Max is defined as the voltage (V_{IN}-V_{OUT}) at which typical qualification devices (98% devices, 95% confidence) survived at least 100 trip cycles and 24hours trip endurance at the specified voltage (V_{IN}-V_{OUT}) and current (I_{PTC}). V_{INT} Max testing is conducted using a "shorted" load (V_{OUT} = 0V). V_{INT} Max is a survivability rating, not a performance rating.
- Note 9: I_{FLT} Max: I_{FLT} Max relates to the steady state current flowing through the diode portion of the PolyZen device in a fault condition, prior to a trip event. I_{FLT} Max is defined as the current at which typical qualification devices (12 parts per lot from 3 lots) survived 100 test cycles. RMS fault currents above I_{FLT} Max may permanently damage the diode portion of the PolyZen device. Testing is conducted with NO load connected to V_{OUT}, such that I_{OUT} = 0. "Test voltage" is defined as the voltage between V_{IN} to GND and includes the PolyZen Diode drop. Specification is dependent on the direction of current flow through the diode. I_{FLT} Max is a survivability rating, not a performance rating.
- Note 10: The power dissipated by the device when in the "tripped" state, as measured on Littelfuse test boards (see note 3).
- Note 11: Specifications based on limited qualification data and subject to change.

MECHANICAL DIMENSIONS

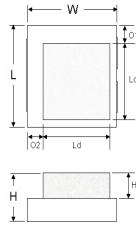

		Min	Typical	Max
Length	L	3.85 mm (0.152")	4 mm (0.16")	4.15 mm (0.163")
Width	W	3.85 mm (0.152")	4 mm (0.16")	4.15 mm (0.163")
Height	H	1.4mm (0.055")	1.7 mm (0.067")	2.0 mm (0.081")
Length Diode	Ld	-	3.0 mm (0.118")	-
Height Diode	Hd	-	1.0 mm (0.039")	-
Offset	O1	-	0.6 mm (0.024")	-
Offset	O2	-	0.7 mm (0.028")	-

SOLDER REFLOW RECOMMENDATIONS:

Classification Reflow Profiles	
Profile Feature	Pb-Free Assembly
Average Ramp-Up Rate (T _{smax} to T _p)	3° C/second max.
Preheat	
• Temperature Min (T _{smin})	150 °C
• Temperature Max (T _{smax})	200 °C
• Time (t _{smin} to t _{smax})	60-180 seconds
Time maintained above:	
• Temperature (T _L)	217 °C
• Time (t _L)	60-150 seconds
Peak/Classification Temperature (T_p)	260 °C
Time within 5 °C of actual Peak	
Temperature (t _p)	20-40 seconds
Ramp-Down Rate	6 °C/second max.
Time 25 °C to Peak Temperature	8 minutes max.

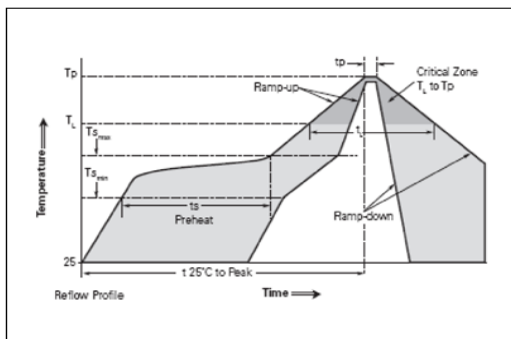

PACKAGING

Packaging	Tape & Reel	Standard Box
ZEN056V115A24LS	3,000	15,000

Reel Dimensions for PolyZen Devices

$A_{max} = 330$
$N_{min} = 102$
$W_1 = 8.4$
$W_2 = 11.1$

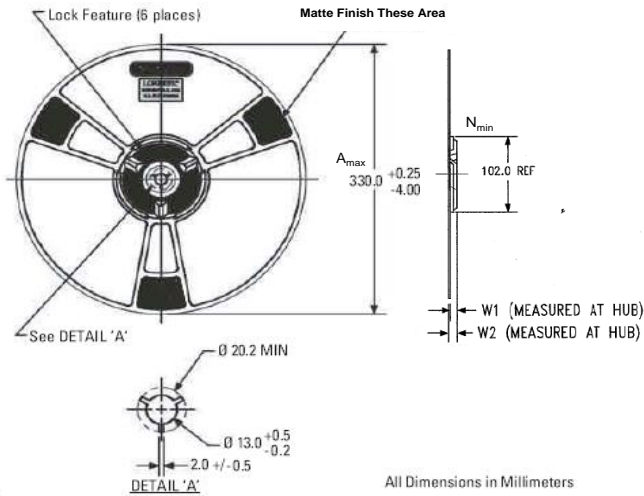

Taped Component Dimensions for PolyZen Devices

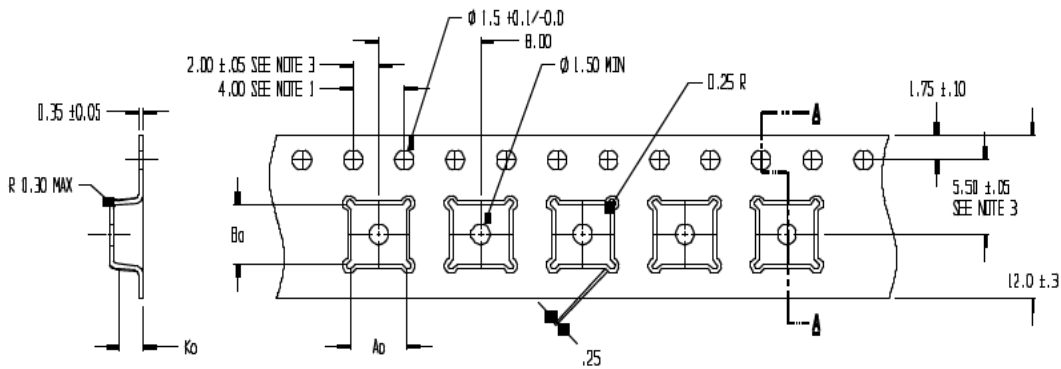

NOTES:

- | | |
|-----------|---|
| Aa = 4.35 | 1. JO SPROCKET HOLE PITCH CUMULATIVE TOLERANCE ±0.2 |
| Ba = 4.35 | 2. CAMBER IN COMPLIANCE WITH EIA 481 |
| Ka = 2.30 | 3. POCKET POSITION RELATIVE TO SPROCKET HOLE MEASURED AS TRUE POSITION OF POCKET, NOT POCKET HOLE |

TYPICAL CHARACTERISTICS

Typical Fault Response:
ZEN056V115A24LS

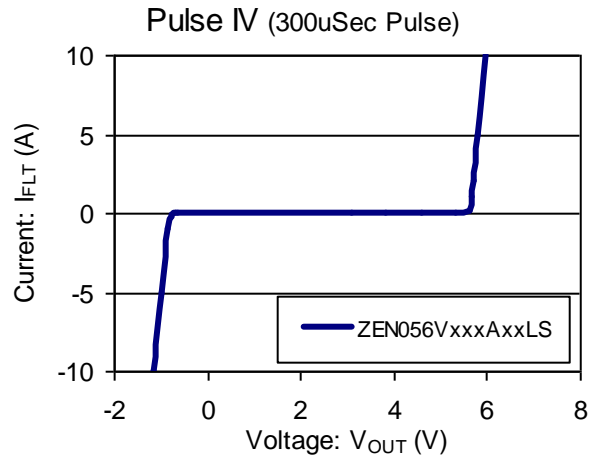
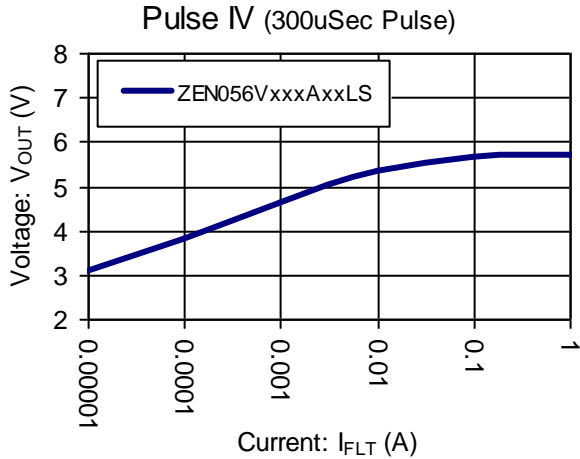
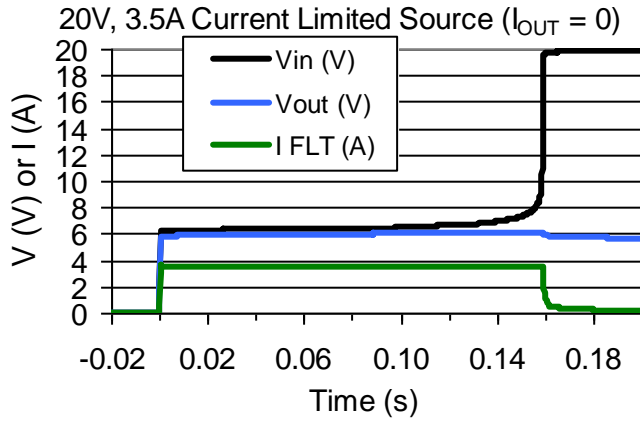

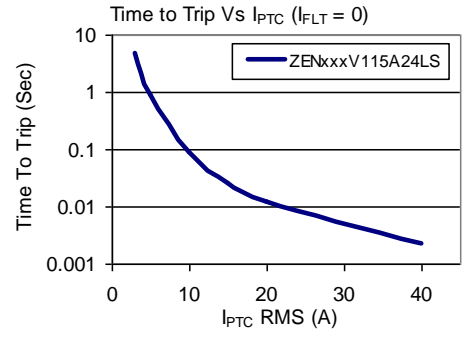
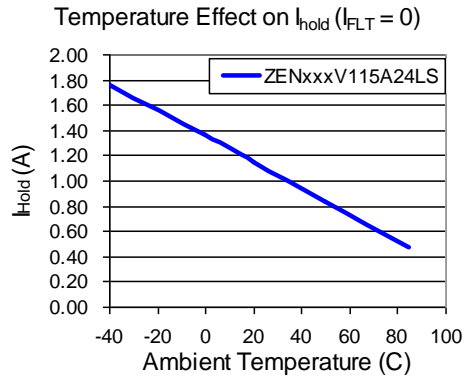
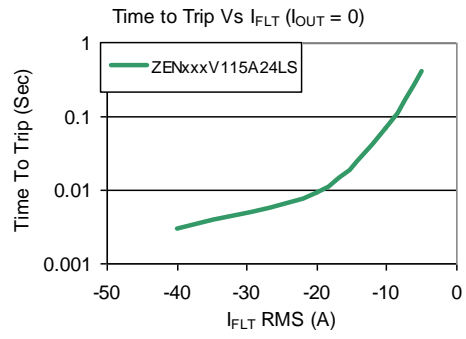
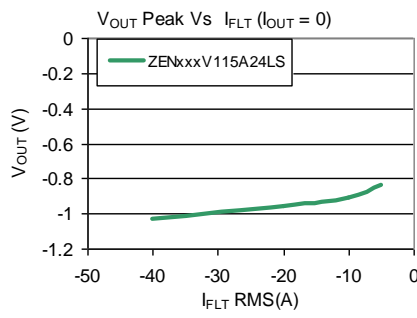
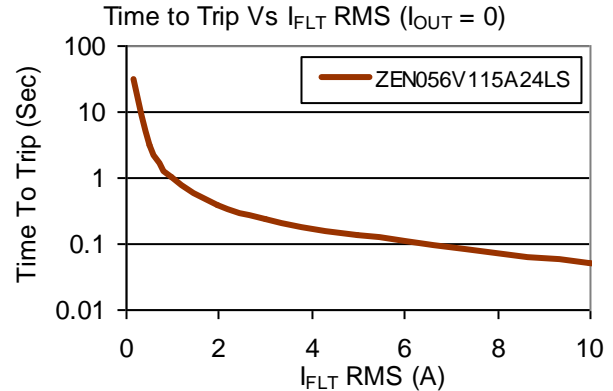
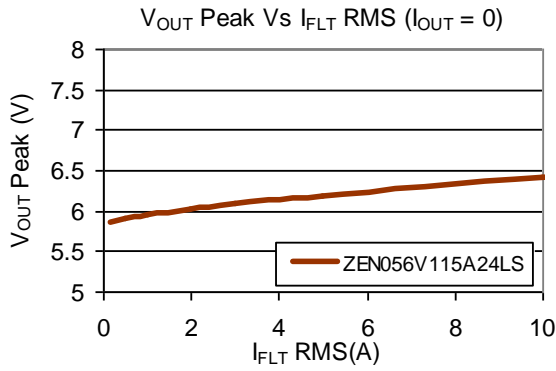

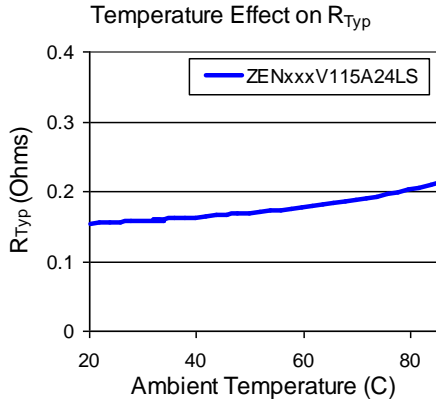

Materials Information

ROHS Compliant

Directive 2002/95/EC
Compliant

ELV Compliant

Directive 2000/53/EC
Compliant

Pb-Free



Halogen Free*



* Halogen Free refers to: **Br**≤900ppm, **Cl**≤900ppm, **Br+Cl**≤1500ppm.

Littelfuse products are not designed for, and shall not be used for, any purpose (including, without limitation, automotive, military, aerospace, medical, life-saving, life-sustaining or nuclear facility applications, devices intended for surgical implant into the body, or any other application in which the failure or lack of desired operation of the product may result in personal injury, death, or property damage) other than those expressly set forth in applicable Littelfuse product documentation. Warranties granted by Littelfuse shall be deemed void for products used for any purpose not expressly set forth in applicable Littelfuse documentation. Littelfuse shall not be liable for any claims or damages arising out of products used in applications not expressly intended by Littelfuse as set forth in applicable Littelfuse documentation. The sale and use of Littelfuse products is subject to Littelfuse Terms and Conditions of Sale, unless otherwise agreed by Littelfuse.