

LS0504EVT233

5V, 4A eFuse with Over Voltage and Over Current Protection

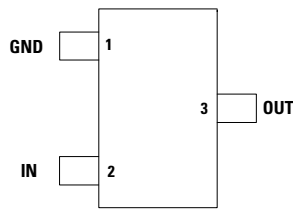

Pinout Designation



SOT23_3L TOP VIEW

Pin Description

Pin no.	Pin Name	Description
1	GND	Ground pin
2	IN	Input pin
3	OUT	Output pin. OUT is discharged to GND through an internal 80Ω resistor during OVP event.

Functional Block Diagram

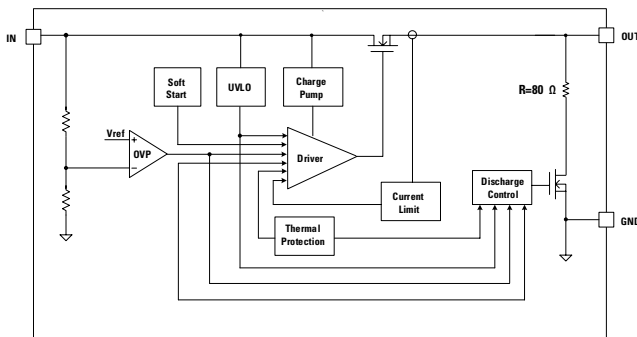

Description

The integrated load switching of the LS0504EVT233 provides robust, input over-current protection to the downstream circuit systems. The device comes with built-in over-voltage protection and internal soft start. The switch's low RDS(ON) minimizes the system's power loss.

In the event of input over-voltage, LS0504EVT233 immediately turns off the switch to prevent the downstream system from the stress of excessively high voltage. Internal soft-start ensures a smooth output voltage ramp-up and limits the input inrush current.

Features & Benefits

- Wide Input Voltage Range from 2.7V to 6V
- 30V Maximum Input / Output Voltage
- 50mΩ Low RDS(ON) Protection Switch
- Built-in Over-Voltage Protection
- Discharge Output at OVP
- Internal Soft-Start
- Thermal Shutdown
- Continuous Current 3A; Peak Current 4A
- Hiccup Mode Protection for Over Load or Short Circuit
- SOT23_3L Package
- Pb-Free and RoHS compliant

Applications

- Bluetooth Headsets
- Wearable Device
- Tablet PC
- Charging Cable
- Battery Devices
- Adapter Powered Devices

Typical Applications

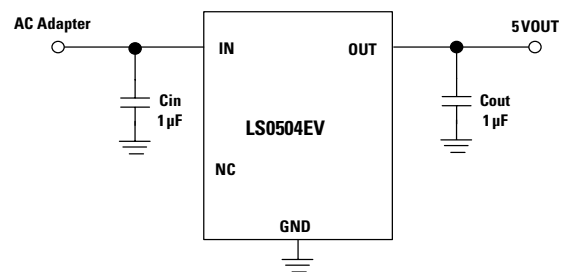

LS0504EVT233

5V, 4A eFuse with Over Voltage and Over Current Protection

Absolute Maximum Rating (Reference to GND)

Symbol	Value	Units
IN, OUT	-0.3 to +30	V
ILIM	-0.3 to +6.5	V
ESD, Human Body Model (HBM)	±2000	V
Junction Temperature Range	-40 to +150	°C
Storage Temperature Range	-65 to +150	°C
Lead Temperature (Soldering 10s)	260	°C

Notes:

- Stress exceeding those listed "Absolute Maximum Ratings" may damage the device.
- ESD HBM testing per JESD22-A114F

Recommend Operating Conditions

Symbol	Value	Units
Input Voltage (IN)	+2.7 to +28	V
Junction Temperature Range	+125	°C

* Notes: The device is not guaranteed to function outside of the recommended operating conditions.

Thermal information

Symbol	Value	Units
Maximum Power Dissipation ($T_A=25^\circ\text{C}$)	0.88	W
Thermal Resistance (θ_{JA})	142	°C/W
Thermal Resistance (θ_{JC})	74	°C/W

Notes:

- Measured on JESD51-7, 4-Layer PCB.
- The maximum allowable power dissipation is a function of the maximum junction temperature $T_{J,MAX}$, the junction to ambient thermal resistance θ_{JA} , and the ambient temperature T_A . The maximum allowable continuous power dissipation at any ambient temperature is calculated by $P_{D,MAX}=(T_{J,MAX}-T_A)/\theta_{JA}$. Exceeding the maximum allowable power dissipation will cause excessive die temperature, and the regulator will go into thermal shutdown. Internal thermal shutdown circuitry protects the device from permanent damage.

Electrical Characteristics ($T_A = +25^\circ\text{C}$, $V_{IN}=5\text{V}$, $C_{IN}=1\mu\text{F}$, unless otherwise specified)

Symbol	Parameter	Test Conditions	Min	Typ	Max	Unit
V_{IN}	Input Voltage Range		2.7		28	V
I_{BIAS}	Quiescent Current			200	260	μA
V_{UV}	Input Under-voltage Threshold			2.48		V
V_{UVHYS}	Input Under-voltage Hysteresis			180		mV
V_{OV}	Input Over-voltage Threshold			6.2		V
V_{OVHYS}	Input Over-voltage Hysteresis			330		mV
T_{SS}	Soft-start Slew Rate Time			230		μs
I_{OUT}	Continuous Output Current		0		3	A
R_{DISCH}	OUT Discharging Resistance	$V_{IN}=6.5\text{V}$		80		Ω
T_{SD}	Thermal Shutdown Temperature			160		°C
T_{HYS}	Thermal Shutdown Hysteresis			40		°C

LS0504EVT233

5V, 4A eFuse with Over Voltage and Over Current Protection

Quiescent Current vs. Input Voltage

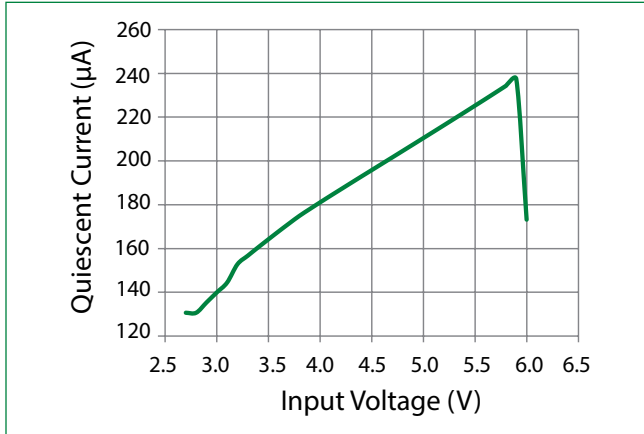

V_{IN} On (5V_{IN}, I_O=0A)

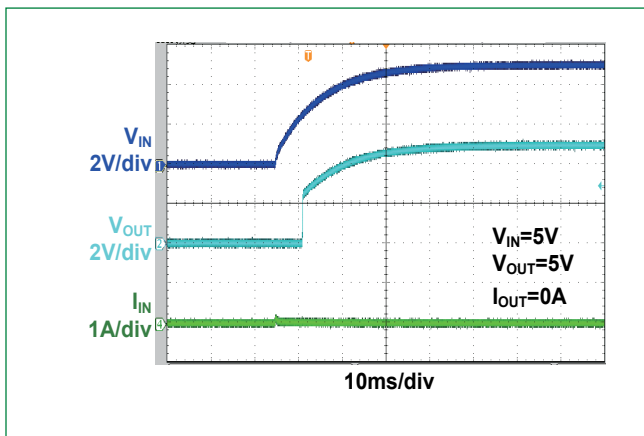

V_{IN} Off (5V_{IN}, I_O=0A)

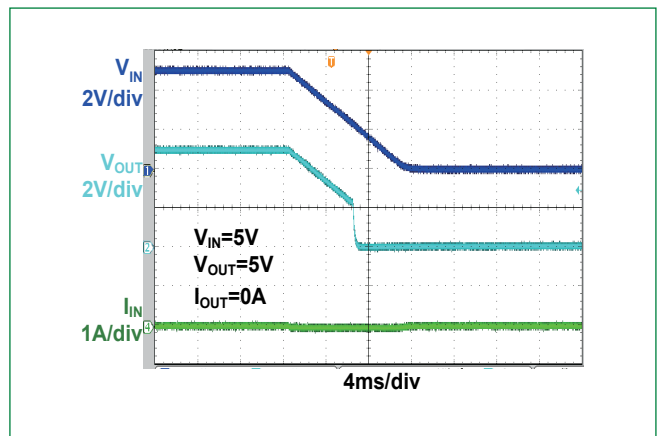

V_{IN} On (5Vin, I_O=3A)

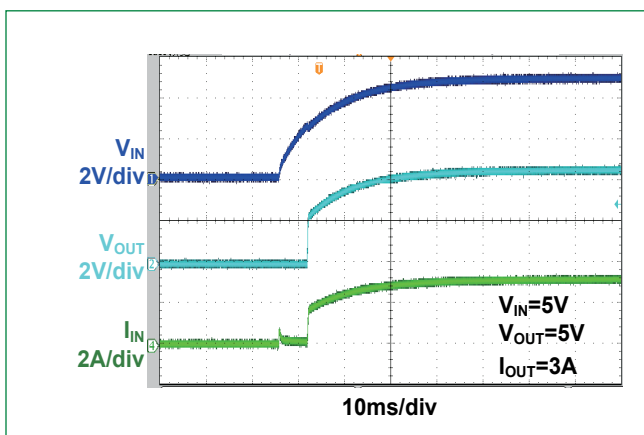

V_{IN} Off (5Vin, I_O=3A)

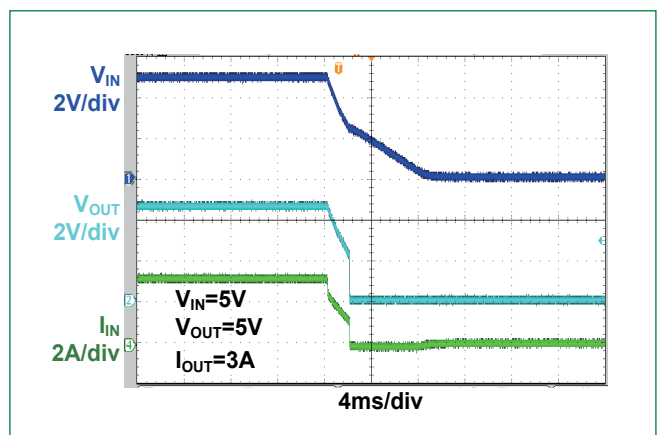

LS0504EVT233

5V, 4A eFuse with Over Voltage and Over Current Protection

Soft Start (3.3V_{IN}, I_O=0A)

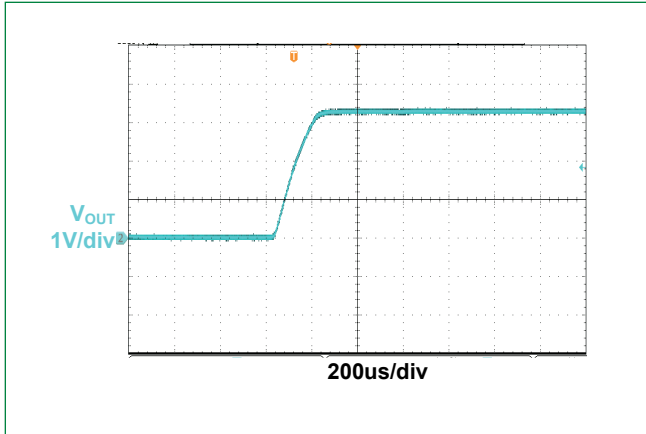

Soft Start (5V_{IN}, I_O=0A)

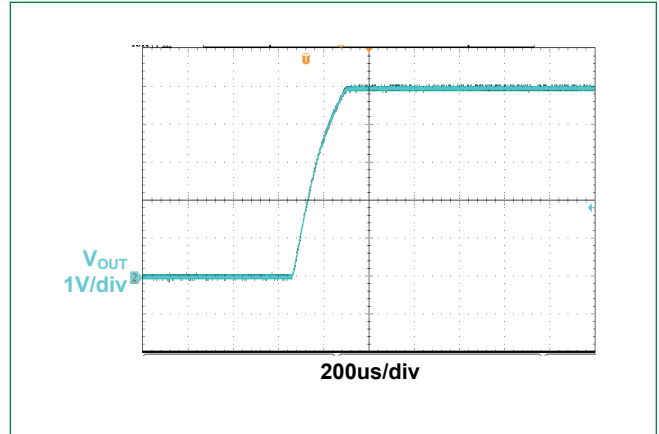

Current Limit (5V_{IN})

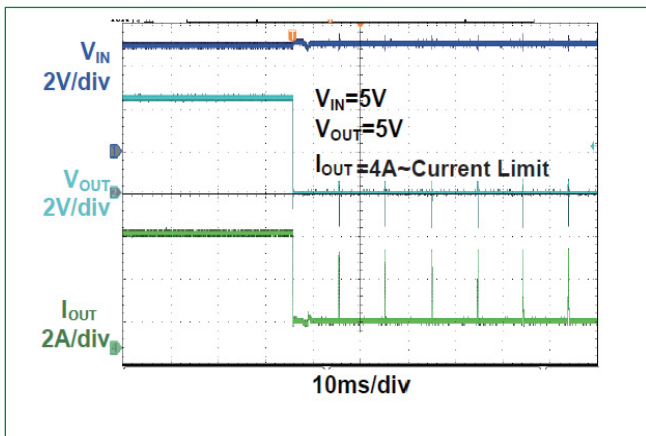

Over Voltage Protection (5V_{IN} Application, I_O=1A)

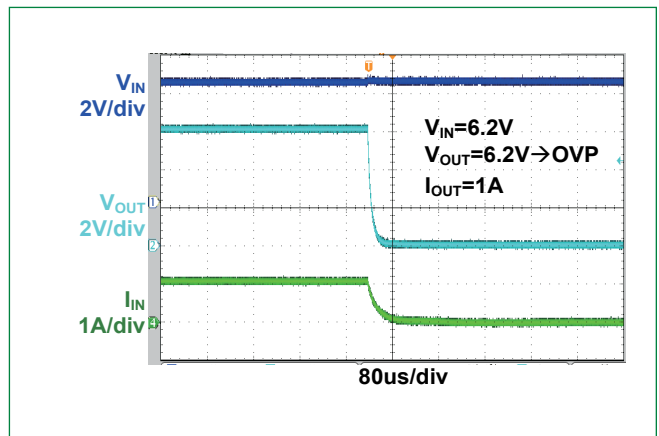

Short Protection (5V_{IN})

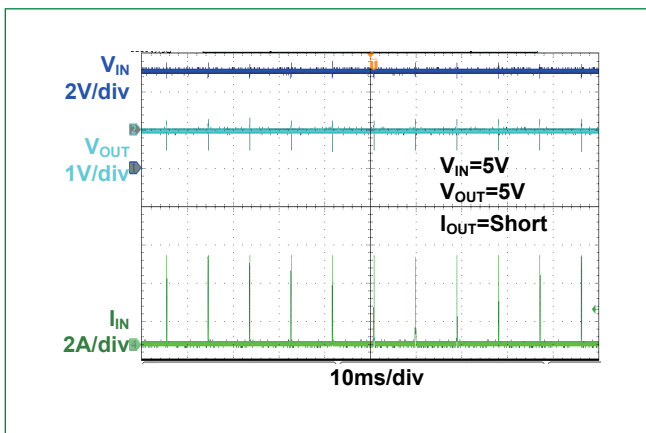

LS0504EVT233

5V, 4A eFuse with Over Voltage and Over Current Protection

Detailed Description

The LS0504EVT233 is a fully integrated load switch with built-in over-voltage protection, internal soft-start, and current limit. When the input voltage is within the valid range (2.7V ~28V), the output pin OUT will ramp up with a fixed slew rate defined by an internal soft start. After OUT ramps up to the input level, the internal load switch is fully turned on and ready to supply power to the system. LS0504EVT233 continuously monitors the system load current through the switch when powering on. Once the load current reaches the current limit, LS0504EVT233 will regulate the load current for 60 μ s to prevent the load current from running away. After 60 μ s, if the current limit condition sustains, LS0504EVT233 will turn off the load switch, wait for 8ms and then try to restart. In the event of system short circuit failure, the load current could jump significantly higher than the current limit. Whenever the load current is 2A larger than the current limit level, LS0504EVT233 immediately turns off the load switch to prevent a disastrous outcome, then also for 8ms before it tries to restart. LS0504EVT233 has an internal input OVP to protect the system from being stressed by excessively high voltage. Once it detects input voltage is higher than the built-in over-voltage threshold, LS0504EVT233 immediately turns off the load switch. The load switch will be automatically turned on once the input voltage falls within the valid range. The LS0504EVT233 also has thermal shutdown protection; when device temperature (T_J) exceeds T_{SHDN} , typically 160°C, the thermal shutdown circuitry will shut down the internal MOSFET, thereby disconnecting the load from the input supply. The LS0504EVT233 will remain off during a cooling period until the device temperature falls below $T_{SHDN} - 40^\circ\text{C}$, after which it will attempt to restart.

Input and Output Capacitor Selection

The LS0504EVT233 require $\geq 1\mu\text{F}$ input and output capacitor connected to GND. X7R type capacitors are recommended, but X5R and others may be used.

PCB Layout Guideline

- For all applications, a 0.1 μF or greater ceramic decoupling capacitor is recommended between IN terminal and GND, and a 0.1 μF or greater ceramic decoupling capacitor is recommended between OUT terminal and GND. For hot-plug applications, where input power path inductance is negligible, this capacitor can be eliminated/minimized.
- The optimum placement of decoupling capacitor is closest to the IN and GND terminals of the device. Care must be taken to minimize the loop area formed by the bypass-capacitor connection, the IN terminal, and the GND terminal of the IC.
- High current carrying power path connections should be as short as possible and should be sized to carry at least twice the full-load current.
- The GND terminal must be tied to the PCB ground plane at the terminal of the IC. The PCB ground should be a copper plane or island on the board.
- Obtaining acceptable performance with alternate layout schemes is possible; however, this layout has been shown to produce good results and is intended as a guideline.

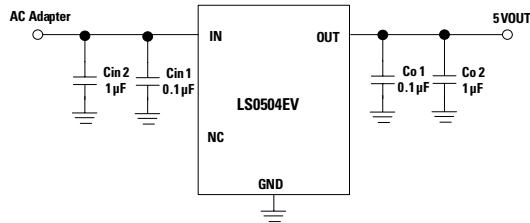
LS0504EVT233**5V, 4A eFuse with Over Voltage and Over Current Protection****Application Schematic****Bill of Materials**

Qty	Ref	Value	Description	Package
2	CIN2, CO2	1µF	Ceramic Capacitor, 35V, X5R	0805
2	CIN1, CO1	0.1µF	Ceramic Capacitor, 35V, X5R	0603
1	R1	NC	Resistor, ±1%	0603
1	U1	LS0504EVT233	eFuse IC	SOT23-3

Soldering Parameters

Average ramp up rate (T_{smin} to T_p)	1~2°C/second, 3°C/second max.	
Preheat & Soak	- Temperature Min (T _{s(min)})	150°C
	- Temperature Max (T _{s(max)})	200°C
	- Time (min to max) (t _s)	60 – 120 secs
Time maintained above	- Temperature (T _L)	217°C
	- Time (t _L)	60~150 seconds
Peak Temperature (T_p)	See Classification Temp intable1	
Time within 5°C of actual peak Temperature (t_p)	30 seconds max	
Ramp-down Rate	6°C/second max	
Time 25°C to peak Temperature (T_p)	8 minutes Max.	

Notes:

1. Tolerance for peak profile Temperature (T_p) is defined as a supplier minimum and a user maximum.
2. Tolerance for time at peak profile temperature (t_p) is defined as a supplier minimum and a user maximum.

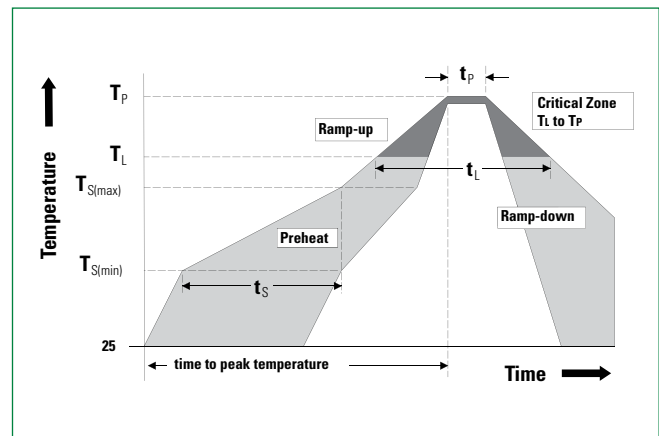
**Ordering Information**

Part Number	Package	Min. Order Qty.
LS0504EVT233	SOT23_3L	3000/Tape & Reel

Pb-free Process – Classification Temperatures (T_c)

Package Thickness	Volume mm ³ <350	Volume mm ³ 350-2000	Volume mm ³ >2000
<1.6mm	260°C	260°C	260°C
1.6mm~2.5mm	260°C	250°C	245°C
>2.5mm	250°C	245°C	245°C
-	3,4,5,6	NC	No Connection

Note: For all temperature information, please refer to top side of the package, measured on the package body surface.

LS0504EVT233

5V, 4A eFuse with Over Voltage and Over Current Protection

Part Numbering

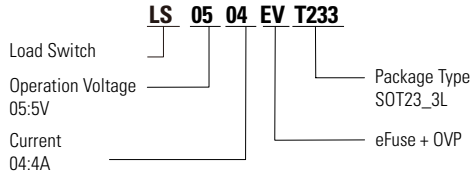

Part Marking

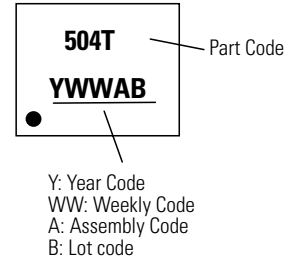

Dimensions — SOT23_3L

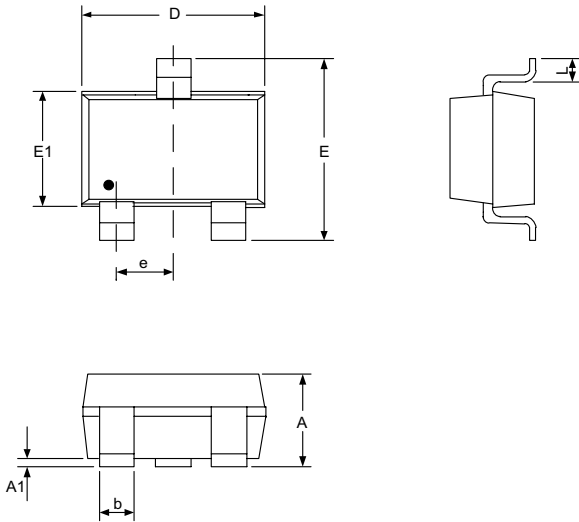

Dimension	Millimeters		Inches	
	MIN	MAX	MIN	MAX
A	-	1.45	-	0.057
A1	0.00	0.15	0.000	0.006
b	0.30	0.50	0.012	0.020
D	2.90		0.114	
E1	1.60		0.063	
e	0.95		0.037	
E	2.60	3.00	0.102	0.118
L	0.30	0.60	0.012	0.024

Carrier Tape & Reel Specification — SOT23_3L

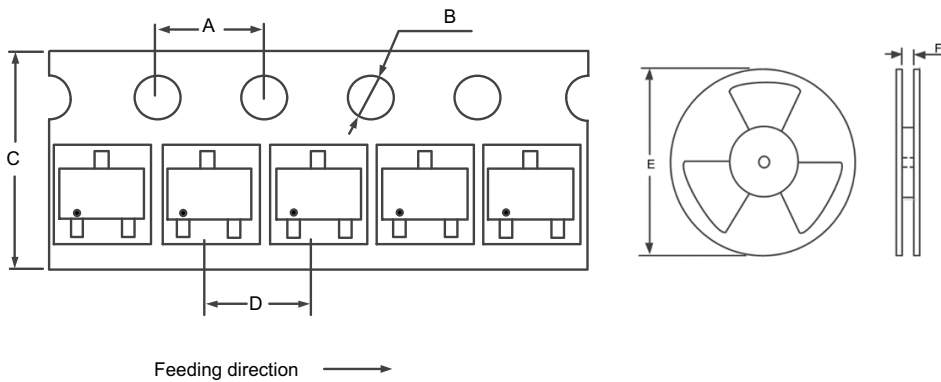

Symbol	Millimeters
A	4.0
B	1.5
C	8.0
D	4.0
E	7 inch
F	9.0

Product Disclaimer - Littelfuse products are not designed for, and shall not be used for, any purpose (including, without limitation, automotive, military, aerospace, medical, life-saving, life-sustaining or nuclear facility applications, devices intended for surgical implant into the body, or any other application in which the failure or lack of desired operation of the product may result in personal injury, death, or property damage) other than those expressly set forth in applicable Littelfuse product documentation. Warranties granted by Littelfuse shall be deemed void for products used for any purpose not expressly set forth in applicable Littelfuse documentation. Littelfuse shall not be liable for any claims or damages arising out of products used in applications not expressly intended by Littelfuse as set forth in applicable Littelfuse documentation. The sale and use of Littelfuse products is subject to Littelfuse Terms and Conditions of Sale, unless otherwise agreed by Littelfuse. "Littelfuse" includes Littelfuse, Inc., and all of its affiliate entities.
<https://www.littelfuse.com/legal/disclaimers/product-disclaimer.aspx>