

2

1

B

B

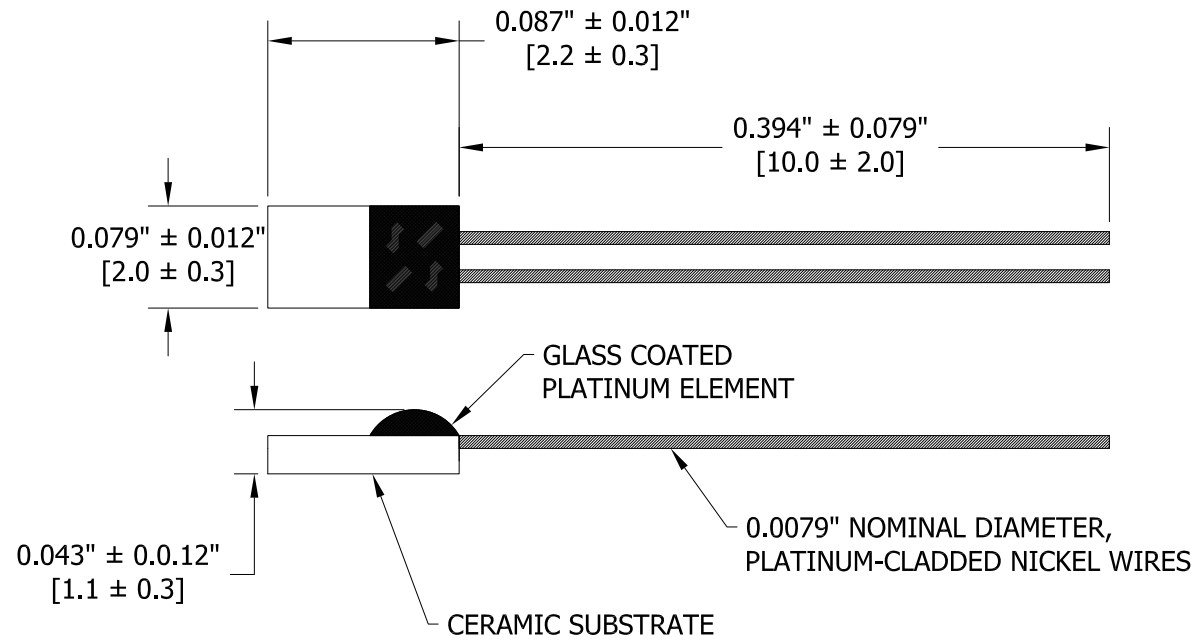

RTD ELEMENT RESISTANCE @ 0°C = 500 Ω ± 0.06%
 RTD ELEMENT ACCURACY @ 0°C = ± 0.15°C
 RTD ELEMENT ACCURACY CLASS = DIN EN 60751 F 0.15 (CLASS A)
 TCR = 3,850 ppm/°C
 TEMPERATURE RATING = -70 TO +500°C
 THERMAL TIME CONSTANT = 10 SECONDS MAXIMUM (2m/SEC MOVING AIR)

A

A

REV	DESC	BY	DATE	DCR NO
B	Mechanical Dimension Changed	MK	01/06/2023	C4768
A	Initial Release	MW	05/08/2019	
REVISION HISTORY				

2

1

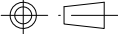
Project Code			
 Third Angle Projection			
Units Inch [mm]		Division IBU - Temperature Sensors	
General Tolerances 0.X = ± 0.X 0.XX = ± 0.XX 0.XXX = ± 0.XXX		Title Platinum RTD Sensor	
Drawn By MK		Drawing No PPG501JA	
Date 01/06/2023		Size A	Do Not Scale Sheet 1

TEMPLATE REVISION CONTROL DCR NO. C0688 REV. A/E DATE 14-11-14