

AC and CG3 Series

Gas Discharge Tubes



Description

Littelfuse AC series two-electrode line protectors provide a high degree of surge protection in AC line applications. The two models, AC120 and AC240 are designed for use with 120VAC and 240VAC lines respectively. They are able to extinguish AC follow-on currents of at least 200A.

Littelfuse CG3 two electrode high voltage (1.0 - 7.5 KV) devices are designed for surge protection and high isolation applications, and for applications for which bias voltages or signal levels of several hundred volts are normally present.

Features

- Rugged ceramic-metal construction
- Available in tape-and-reel packaging
- Low capacitance (<1.5 pF)
- Available with or without leads

Applications

AC Series:

- Long branch circuits (AC wall outlet)
- Short branch circuits (at breaker box, computer, etc)
- Power supplies
- Test equipment
- Submersible pumps
- Medical electronics

CG3 Series:

- CRT terminals
- CATV equipment
- Antennas
- Power supplies
- Medical electronics

Additional Information



Resources
AC Series



Accessories
AC Series



Samples
AC Series



Resources
CG3 Series



Accessories
CG3 Series



Samples
CG3 Series

Agency Approvals

Agency	Agency file number
	E320116*

*Note: CG3 7.5 product UL approval is currently pending

2 Electrode GDT Graphical Symbol

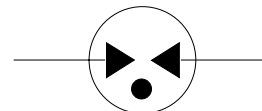

AC and CG3 Series

Gas Discharge Tubes

Electrical Characteristics

Part Number	Device Dimension Type	Device Specifications (at 25°C)						Life Ratings						
		DC Breakdown in Volts (@100V/s)			Impulse Break-down in Volts (@100V/ μ s)	Impulse Break-down In Volts (@1 Kv/ μ sec)	Insulation Resistance	Capacitance (@1MHz)	Arc Voltage (on state Voltage) @1Amp Min	Max Follow On Current ³	Nominal AC Discharge Current (10x1sec @50-60Hz)	AC Discharge Current (1 x 50Hz 9 cycles)	Nominal Impulse Discharge Current ⁴ (@8/20 μ s)	Max Surge Current ⁵ (@8/20 μ s)
		MIN	TYP	MAX	MAX		MIN	MAX	TYP					
AC120 ¹	A	230	285	340	500	550	10 G Ω (at 100V)	<1.5 pf	~ 25 V	200 Amps	5 A	65 A	10 shots 5kA	1 shot 10kA
AC240 ¹	A	480	600	720	1100	1200								
CG3 1.0 ¹	A	800	1000	1200	1400	1500								
CG3 1.1 ¹	A	880	1100	1320	1600	1700								
CG3 1.2 ¹	A	960	1200	1440	1700	1800								
CG3 1.3 ¹	A	1040	1300	1560	1800	1900								
CG3 1.5 ¹	A	1200	1500	1800	1800	2000								
CG3 2.0 ¹	A	1600	2000	2400	2500	2750								
CG3 2.5 ¹	A	2000	2500	3000	3200	3500								
CG3 2.7 ¹	A	2160	2700	3240	3600	4000	10 G Ω (at 100V)	<1.5 pf	~ 25 V	200 Amps	N/A	N/A	10 shots 5kA	1 shot 10kA
CG3 3.0 ¹	A	2400	3000	3600	4000	4200								
CG3 3.3 ¹	A	2640	3300	3960	4600	4700								
CG3 4.0 ²	B	3200	4000	4800	5800	6000								
CG3 4.5 ²	B	3600	4500	5400	6150	6500								
CG3 5.0 ²	B	4000	5000	6000	7500	8000								
CG3 6.2 ^{2,7}	B	4960	6200	7440	8100	9500								
CG3 6.5 ^{2,7}	B	5200	6500	7800	9500	10000								
CG3 7.5 ^{2,6,7}	B	6000	7500	9000	10000	10600								

NOTES:

1. Refer to Production Dimensions section, outline A devices
2. Refer to Production Dimensions section, outline B devices
3. Tested to UL1449 -- 120V r.m.s. for AC120, 230V r.m.s. all others.
Conducted with suitable MOV connected in series.
4. 5x(+) and 5x(-) applications 5kA @ 8/20 μ s
5. 1 application 10kA @ 8/20 μ s
6. CG3 7.5 product UL approval is currently pending
7. When ordering this item, use suffix code D004 when entering the part number.
The older product version without D004 suffix code has been discontinued.
Refer to Part Numbering System section for additional information.

Product Characteristics

Materials	<p>Core Outline A & B items: Device: Tin Plated 17.5\pm12.5 Microns</p> <p>Axial Outline A & B items: Device & Wire: Tin Plated 17.5\pm12.5 Microns</p>
Product Marking	LF Logo, Voltage and date code; Black ink positive print
Glow to arc transition current	< 0.5Amps
Glow Voltage	~ 140 Volts
Storage and Operational Temperature	-40 to +90

AC and CG3 Series Gas Discharge Tubes

Soldering Parameters - Reflow Soldering (Surface Mount Devices)

Reflow Condition		Pb – Free assembly
Pre Heat	- Temperature Min ($T_{s(min)}$)	150°C
	- Temperature Max ($T_{s(max)}$)	200°C
	- Time (Min to Max) (t_s)	60 – 180 secs
Average ramp up rate (Liquidus Temp (T_L) to peak)		3°C/second max
$T_{s(max)}$ to T_L - Ramp-up Rate		5°C/second max
Reflow	- Temperature (T_L) (Liquidus)	217°C
	- Temperature (t_L)	60 – 150 seconds
Peak Temperature (T_p)		260 ^{+0/-5} °C
Time within 5°C of actual peak Temperature (t_p)		10 – 30 seconds
Ramp-down Rate		6°C/second max
Time 25°C to peak Temperature (T_p)		8 minutes Max.
Do not exceed		260°C

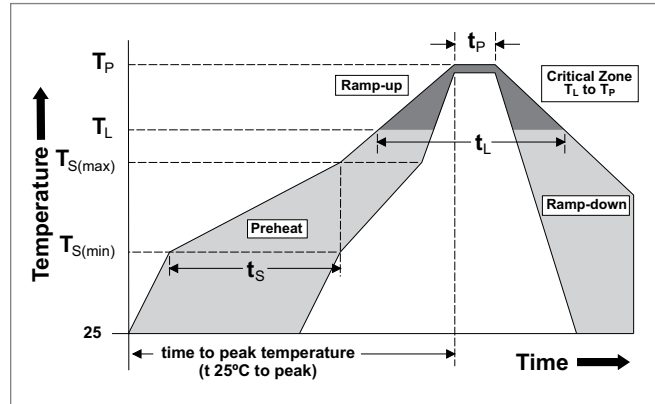

Soldering Parameters - Wave Soldering (Thru-Hole Devices)

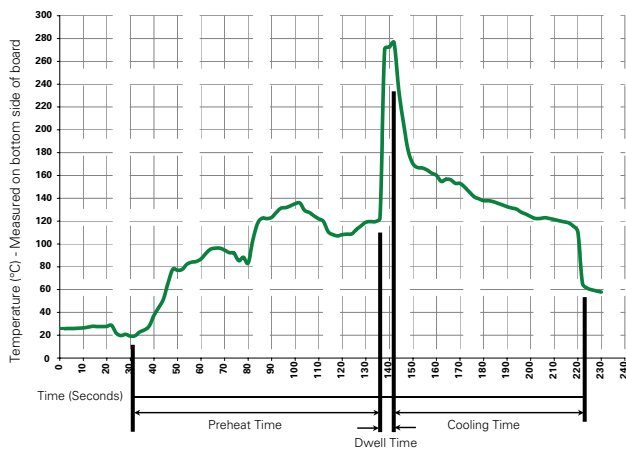

Recommended Process Parameters:

Wave Parameter	Lead-Free Recommendation
Preheat: (Depends on Flux Activation Temperature)	(Typical Industry Recommendation)
Temperature Minimum:	100° C
Temperature Maximum:	150° C
Preheat Time:	60-180 seconds
Solder Pot Temperature:	280° C Maximum
Solder Dwell Time:	2-5 seconds

Soldering Parameters - Hand Soldering

Solder Iron Temperature: 350° C +/- 5°C
Heating Time: 5 seconds max.

AC and CG3 Series

Gas Discharge Tubes

Device Dimensions

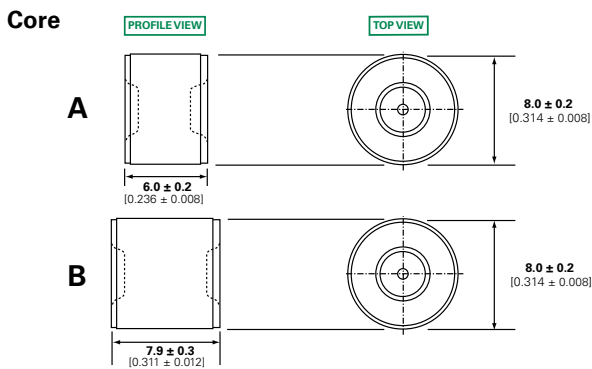
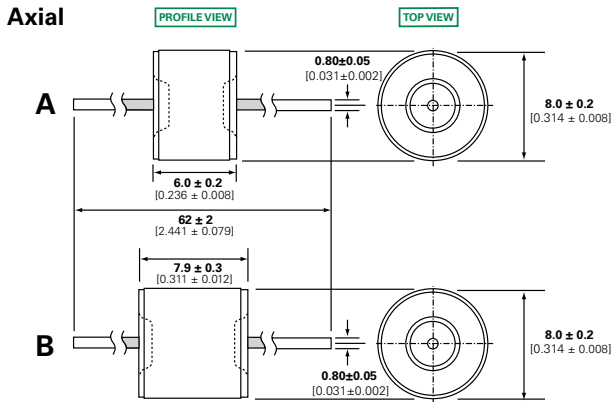

Part Numbering System and Ordering Information

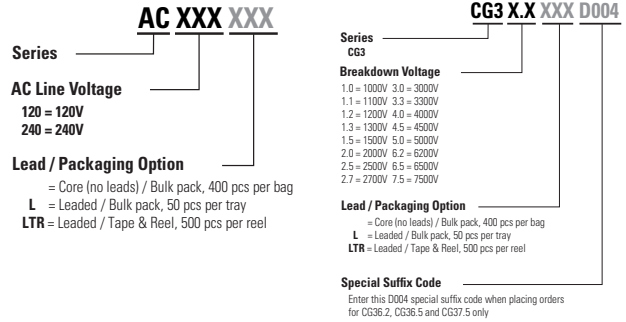

Packaging Dimensions

For 'LTR' Option Code Axial Lead Items

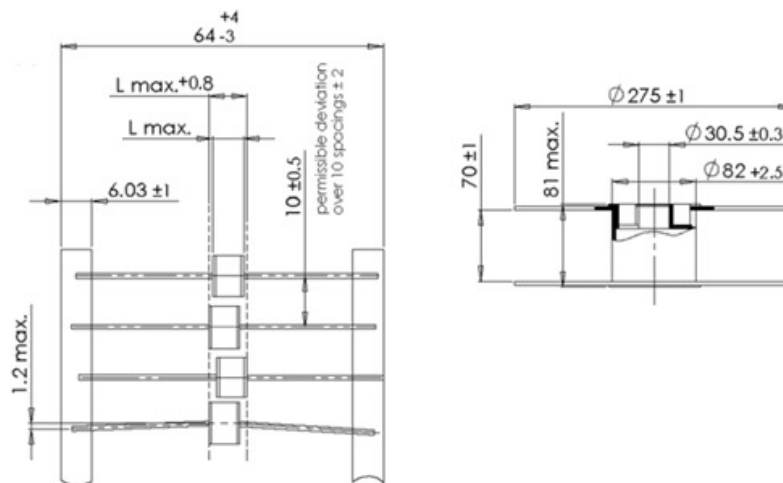

Disclaimer Notice - Information furnished is believed to be accurate and reliable. However, users should independently evaluate the suitability of and test each product selected for their own applications. Littelfuse products are not designed for, and may not be used in, all applications. Read complete Disclaimer Notice at: www.littelfuse.com/disclaimer-electronics.