

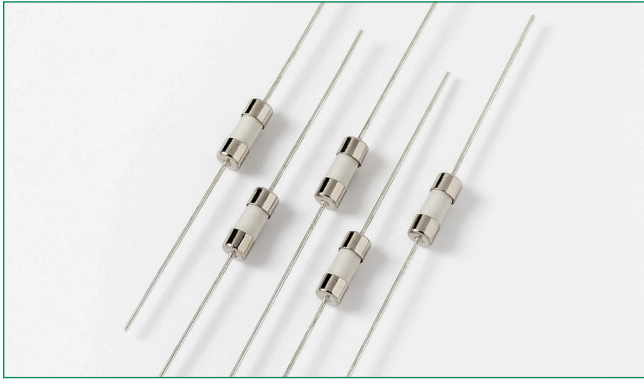





877 Series Fuse, Lead-free 3.6 × 10 mm, Time-Lag Fuse



Agency	Agency File Number	Ampere Range
	40023242	2A – 6.3A
	E10480	2A – 6.3A
	2020970207000014	2A – 6.3A
	SU05024-10002	2A
	SU05024-10001	3.15A - 6.3A
	NBK240212-JP1021	2A – 4A

Additional Information



Datasheet



Resources



Samples

Description

The 877 Series is a single pigtail, axial leaded, 3.6 × 10mm, time-lag fuse.

Features

- Designed to meet IEC 60127-3 Standard Sheet 4
- Single Pigtail Axial Lead format
- Time-Lag, ceramic body fuse in a compact package
- Pb-free, RoHS compliant
- Available in ratings of 2 to 6.3 Amperes





Applications

This space saving fuse is ideally suited for lighting, power supply, and adapter applications.

Electrical Characteristics

% of Ampere Rating	Opening Time
150%	60 minutes, Minimum
210%	2 minutes, Maximum
275%	400 ms., Min.; 10 sec. Max.
400%	150 ms., Min.; 3 sec. Max.
1000%	20 ms. Min.; 150 ms. Max.

Electrical Characteristics

Amp Code	Ampere Rating (A)	Voltage Rating (V)	Interrupting Rating**	Nominal Cold Resistance (Ω)*	Nominal Melting I ² t (A ² sec)	Nominal Voltage Drop (mV)	Nominal Power Dissipation (mW)	Agency Approvals				
												
002.	2.0	250	35A @ 250 V AC	0.035	24.6	82	450	x	x	x	x	x
3.15	3.15	250	35A @ 250 V AC	0.020	67.6	76	690	x	x	x	x	x
004.	4.0	250	40A @ 250 V AC	0.0167	143.4	74	926	x	x	x	x	x
06.3	6.3	250	63A @ 250 V AC	0.0087	190	60	1130	x	x		x	x

Notes:

*Cold resistance measured at less than 10% of rated current at 23°C.

** Interrupting Rating may differ based on Agency Approval. See Agency Approval certificate for more details.

Temperature Re-rating Curve

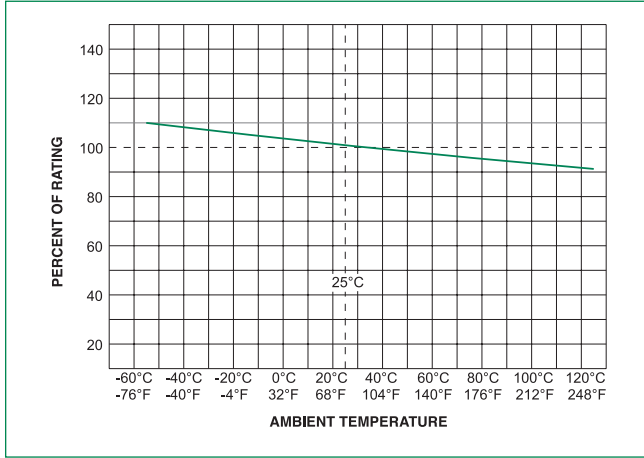

Note:
1. Rerating depicted in this curve is in addition to the standard derating of 25% for continuous operation.

Average Time Current Curves

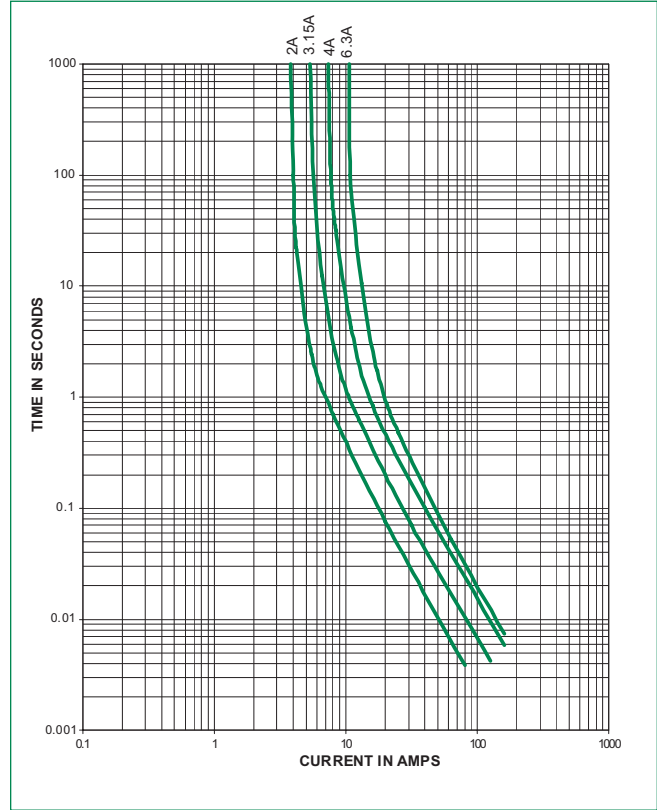

Soldering Parameters - Wave Soldering

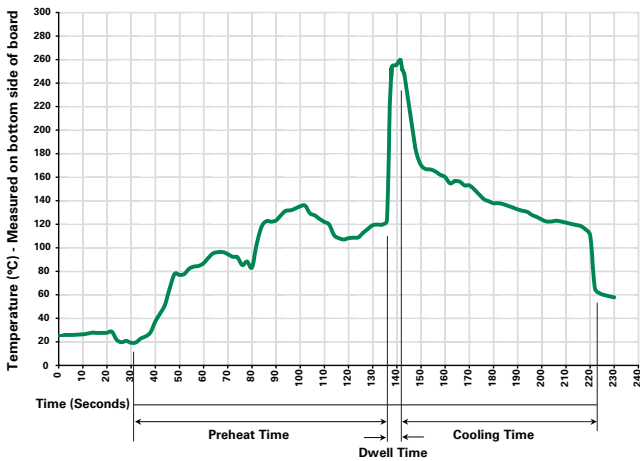

Recommended Process Parameters:

Wave Parameter	Lead-Free Recommendation
Preheat: (Depends on Flux Activation Temperature)	(Typical Industry Recommendation)
Temperature Minimum:	100°C
Temperature Maximum:	150°C
Preheat Time:	60-180 seconds
Solder Pot Temperature:	260°C Maximum
Solder Dwell Time:	2-5 seconds

Recommended Hand-Solder Parameters:

Solder Iron Temperature: 350°C +/- 5°C
Heating Time: 5 seconds max.

Note: These devices are not recommended for IR or Convection Reflow process.

Product Characteristics

Materials	Body: Ceramic Cap: Nickel Plated Brass Tin Plated Copper
Terminal Strength	MIL-STD-202, Method 211, Test Condition A
Solderability	MIL-STD-202, Method 208
Product Marketing	Body: Brand Logo, Current Rating Characteristic "T"; Agency approval marks
Packaging	Bulk (1000 pcs/pkg) Tape and Reel (1000 pcs/reel)

Operating Temperature	-55°C to 125°C
Thermal Shock	MIL-STD-202, Method 107 Test Condition B3 (5 cycles -65°C to +125°C)
Vibration	MIL-STD-202, Method 201 (10-55 Hz)
Humidity	MIL-STD-202, Method 106, High Humidity (90-98%RH), Heat (65°C)
Salt Spray	MIL-STD-202, Method 101, Test Condition B

Dimensions

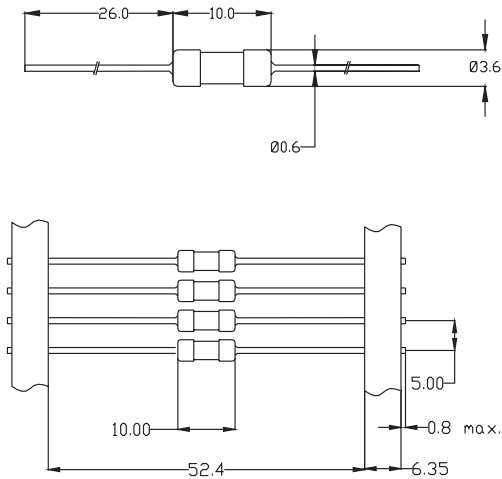

All dimensions in mm

Part Numbering System

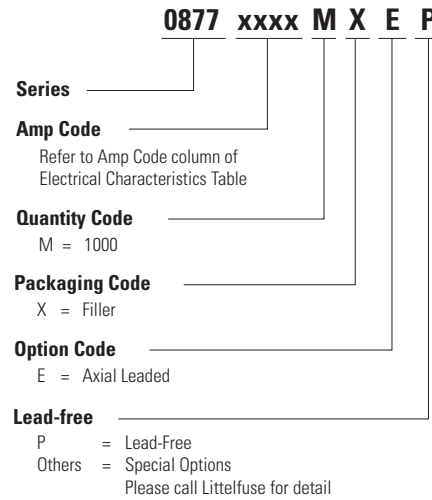

Packaging

Packaging Option	Packaging Specification	Quantity	Quantity & Packaging Code	Taping Width
877 Series				
Bulk	Bulk	1000	MXE	N/A
Tape and Reel	EIA 296	1000	MRET1	T1 = 52mm (2.062")