

Considerations for Selecting Littelfuse Varistors for Industrial Motor Applications

Littelfuse offers specific Varistors to address over-voltage transients in the Industrial environment. This application area is typically characterized as AC utility service entrance and distribution, and the associated high current inductive loads that can include medium and heavy motors. Transient over-voltage suppression in these applications typically require Industrial Metal Oxide Varistors (MOVs) for induced lightning surges or for switching transients created by the motor itself. These situations demand that the MOV ratings match the surges found in these locations in terms of suitably high energy and surge current values. This Application Note discusses the first level considerations for applying Littelfuse Industrial AC Line Metal Oxide Varistors with a motor protection example.

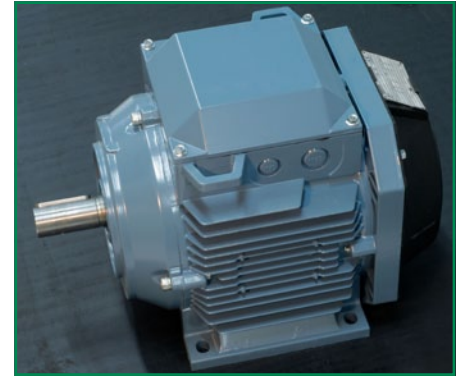

MOV Voltage and Connection

Whether single-, split-, or three-phase service, the operating voltage with suitable tolerance for high line operation is first in the selection process. Table 1 shows the typical AC Mains Service ratings for voltage in the US and the applicable standard MOV operating voltage rating. Figure 1 illustrates the MOV placement in single-phase systems as well as the voltage ratings relationship for 3-phase delta and wye connection schemes. Here, the Neutral/Ground method must be known to determine the Line to Line or Line to Ground connection option and associated voltage amplitudes.

Surge Current, Energy and MOV Size

The Varistor peak surge current rating is primarily a function of the area of the disc itself. Likewise, since an MOV is a clamping device, it has an energy dissipation rating related to the MOV material volume. Available current in industrial applications often require that a physically larger MOV be utilized. Littelfuse Industrial Varistor disc diameters are 20, 32, 40 and 60mm, and 34mm square as shown in Table 2. Selection of a specific size will require some knowledge of the expected peak surge current and waveform duration.

Nominal System Voltage ¹ (low voltage class)	Maximum Utilization Service Voltage ¹	Typical MOV Voltage Types (continuous RMS rating)
120 (two-wire)	127	130, 140, 150
120 / 240 (three-wire)	127/254	130, 140, 150 / 250, 275
208Y / 120 (four-wire)	220Y / 127	L-L= 230, 250, 275 L-G= 130, 140, 150
240 / 120 (four-wire)	254 / 127	L-L= 250, 275 / 130, 140, 150
240 (three-wire)	254	250, 275
480Y / 277 (four-wire)	508 / 293	L-L= 510, 575 L-G= 300, 320, 385
480 (three-wire)	508	510, 550, 575
600 (three-wire)	635	660

1. Per ANSI C84.

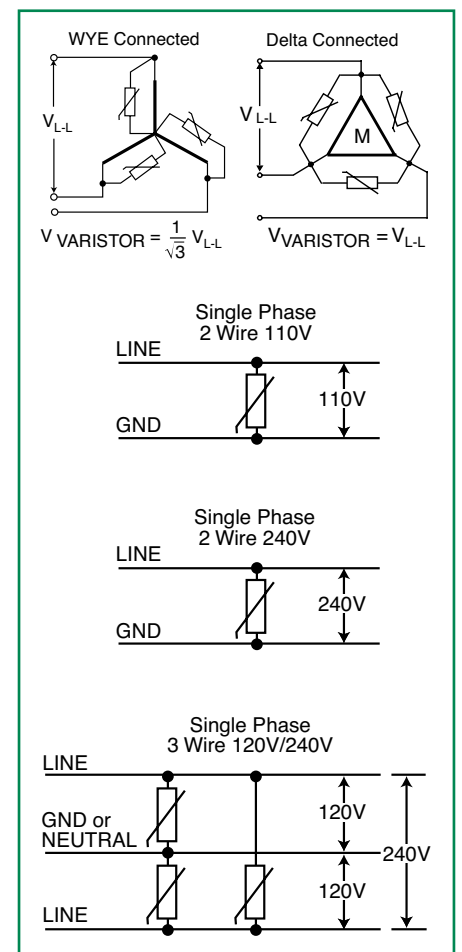

Figure 1

Circuit modeling is preferred. A short circuit analysis of the peak surge voltage divided by the circuit's impedance can provide a "worst case" value. However, short circuit analysis would yield a higher than actual peak current and therefore estimated clamping voltage from the MOV. The respective surge current for each size type is also given in Table 2 for the 8x20 lightning waveform. Most surges follow an exponential rise and decay waveform such as this. In the industrial environment, the Varistor can be called upon to clamp or limit surges of tens of thousands amperes. As stated, the Varistor is a clamping device, a portion of the surge energy is dissipated as heat. The high temperature rise during high current surges requires that the MOV be derated for peak current when pulse duration is longer than 20 microseconds. The derating amount is type dependent. Figure 2 extends to pulses of 10 milliseconds and is an example of the lower voltage 40mm types.

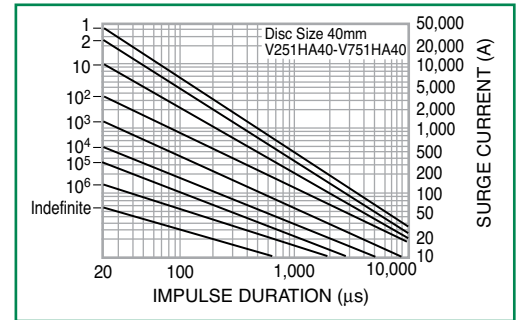

Figure 2. Surge current rating curves for V251HA40-V751HA40

For the same reasons, a limitation must be placed on the number of high current surges applied to an MOV. Littelfuse considers an MOV to be out of specification should its Vnominal voltage shift by 10% or more after a surge. These pulse life ratings are also provided in Figure 2. The level to which the MOV reduces the transient's peak voltage is termed "clamping" voltage and is a function of the current through the MOV. Figure 3 is a family of curves for the HB34 Series illustrating its maximum peak voltage. The designer should be aware of what component or product requires protection and its maximum safe peak voltage that it can safely withstand.

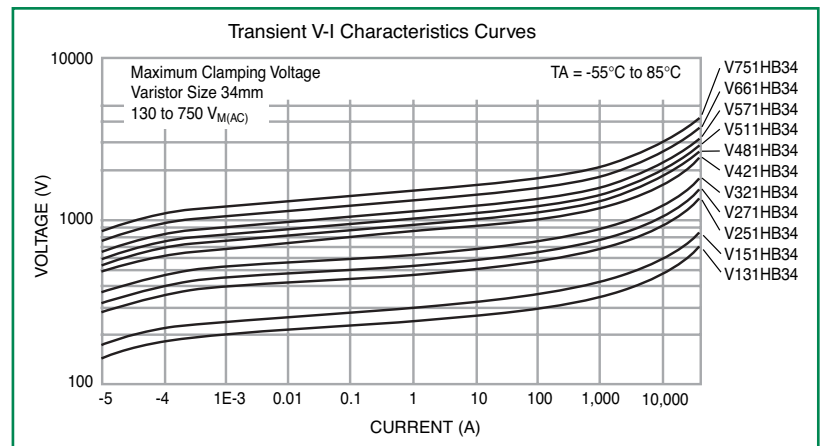







Figure 3. Clamping voltage for V131HB34-V751HB34

Table 2. Littelfuse Industrial High Energy MOV

Series Name		Operating AC Voltage Range	Operating DC Voltage Range	Peak Current Range (A)	Peak Energy Range (J)	Mount/Form Factor	Disc Size
SM20		20-320	26	6500	165	Surface Mount	20mm
BA/BB		130-2800	175-3500	50000 70000	450-10000	Screw/Clip Terminals	60mm
DA/DB		130-750	175-970	40000	270-1050		40mm
HA		130-750	175-970	25000 40000	200-1050	Industrial Packaged Radial Leads	32, 40mm
HB34, HG34, HF34		130-750	175-970	40000	270-1050		34mm
DHB34		250-2800	330-3500	20000 70000	330-10000		34mm

Motors usually generate heat and vibration; thus, the environment where the Varistor has been placed should also be put into consideration. Littelfuse SM20 Series, designed for 85°C environment, is a surface-mount Varistor and performed better in vibration environment than radial leaded Varistors.

Design Example - Transient suppression considerations for an AC motor

One aspect of AC motor protection is the surge withstand capability of the motor itself. Paragraph 20.36.4 of the NEMA motor generator standard MG-1 defines a unit value of surge as: $u \times V_{L-L}$ (or, $0.816 \times V_{L-L}$) For transient rise times of 0.1 to 0.2 μ S, twice the unit value of surge capability is required on stator windings. When rise times reach 1.2 μ S or greater, 4.5 times the unit value is stipulated. In the case of external transients such as lightning, this would equate to a surge voltage capability of 918V peak for a 230V motor (F.L.A. of 12A) on a 250 high line condition. Since lightning surges can exceed these values, a suppression element would be required to protect the stator windings.

Taking high line tolerance into account, a 275VAC rated MOV may be chosen for this example. A Littelfuse V271HB34 MOV is initially considered based upon desired form factor.

Using a 2HP single-phase, medium-sized motor, the MOV's surge current rating would be determined by the peak current induced at the motor supply. Assuming a service location for the motor and line impedance of 2 ohms, it is determined that a 3kA lightning surge is possible.

Maximum clamping voltage at 3kA is verified from the data sheet at 900V, below the 918V suggested stator winding withstand capability.

It is determined that the operational life of the motor is 20 years and that it be capable of 80 lightning transients during its service. The data sheet of the MOV is referenced for pulse rating curves which verifies a rating of more than 100 such surges.

The ambient operating temperature for this application is 0° to +70° C. This is within the MOV's -40 to +85° C rating. Likewise, it does not require derating of surge current or energy in this range.



Littelfuse SM20 Series – surface mount Varistor for severe vibration environment

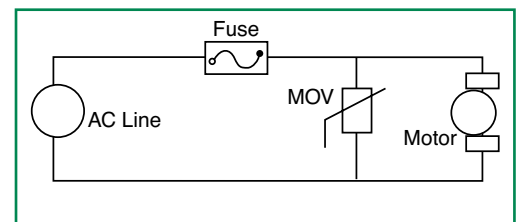

Figure 4.

In addition to external transients, normal operation motor switching transients must be suppressed in order to reduce transients induced on the AC line and to protect adjacent electronic components. In the case of stored inductive energy, the locked rotor current rating of the motor is considered. The release of this energy either through a mechanical contact opening or fuse blowing can result in significant transient voltage. In this example, the locked rotor current is used as a worst case situation and is 65A from NEMA MG-1 in this case. Assuming enough time prior to contactor opening or fuse clearing, the stored energy is $1/2LI^2$. Motor saturated inductance in millihenries must be determined. A portion of the resultant Joule energy would then be dissipated within the MOV. Additionally, exceeding the surge current or energy dissipation ratings of an MOV can result in damage to it. Since the failure mode is a short circuit, Littelfuse recommends either source (line) or direct MOV over-current protection. Scenarios that could place the MOV at risk include abnormally high line voltage, such as through loss of Neutral connection, or unanticipated transient energy.

Conclusion

Over-voltage situations, such as lightning surges or motor switching transients, can be addressed to protect motors in medium and heavy industrial applications. The determination of application conditions such as transient voltage type, magnitude and frequency are required to identify matching ratings of the Varistor.

Visit www.littelfuse.com/varistors.html for technical application articles and reference designs serving a wide range of applications.