

LCFA Series

RoHS

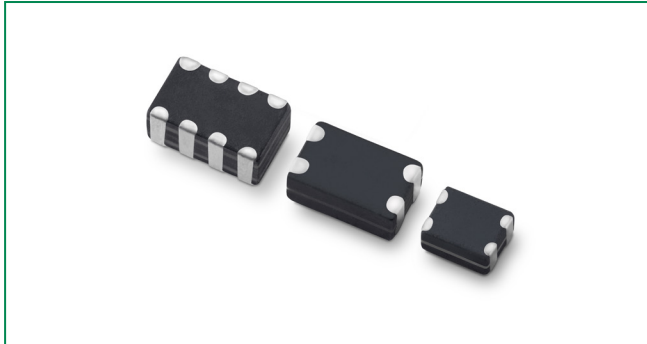

Pinout

LCFA121002A900TG, LCFA121002B900TG, and LCFA201202A900TG



Item	Description	Source	Equipment
Rdc	Pin 1-3, 2-4	10mA DC Source	Source Meter
CM Impedance	Pin 1-2(Short) to Pin 3-4(Short)		LCR Meter (3GHz)

LCFA201204A101TG

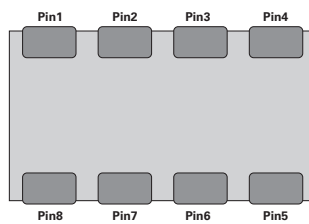

Item	Description	Source	Equipment
Rdc	Pin 1-8, 2-7, 3-6, 4-5	10mA DC Source	Source Meter
CM Impedance	Pin 1-2(Short) to Pin 8-7(Short) Pin 3-4(Short) to Pin 6-5(Short)		LCR Meter (3GHz)

Description

LCFA Series cover the engineering requirements of Common Mode Noise Filter (CMF) for high speed differential serial interfaces, such as USB 3.1, USB 2.0, MIPI D-PHY/HDMI and RGB line, and LVDS line. This AEC-Q200 qualified common mode noise filter will help to choke and attenuate the noise of the growing number of electronic applications in modern vehicles.

Features

- AEC-Q200 qualified
- Effective for suppressing common mode noise and almost no effect for high speed differential data line
- Differential mode cut-off frequency up to 4.65GHz at -3dB
- Low profile package
- Ceramic multilayer type SMD component
- Non-polarized product
- Conforming to RoHS directive
- High temperature soldering guaranteed: 260°C/10 seconds

Applications

- Automotive Infotainment: Display, Car Navigation, Head Unit, USB Jack
- ADAS: Car Camera System
- Automotive Telematics Control Unit, E-Call system, and Smart Keyless Entry system
- Automotive RGB line, LVDS line, HDMI for AVN, and High-speed CAN BUS line
- PDP, LCD TV, DVD Player, PC, Audio player, DSC, Set top box, Laptop, SSD, and Home Automation
- Portable/Wearable Devices
- Mobile phone, Tablet, Game console, POS, VR, and Dongle

Functional Block Diagram

LCFA121002A900TG, LCFA121002B900TG, and LCFA201202A900TG

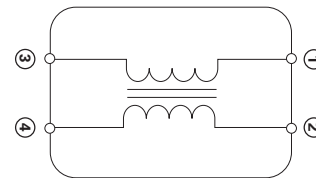

①~④: Data Line

LCFA201204A101TG

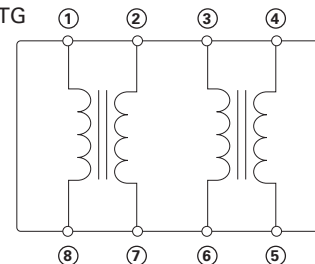

①~⑧: Data Line

Electrical Characteristics

Part Number	Size (mm)	Size (inch)	Common Mode Impedance (Ω)	Rated Current (mA) Max.	Cut-off Freq/ GHz	DC Resistance (Ω) Max.	Number of Lines	Leakage Current (μ A) Max.	Insulation Resistance ($M\Omega$) Min.
LCFA121002A900TG	1210	0504	90(\pm 25%)	100	4.65	4.0	2	1.0	10
LCFA121002B900TG	1210	0504	90(\pm 25%)	150	4.65	4.0	2	1.0	10
LCFA201202A900TG	2012	0805	90(\pm 25%)	100	3.89	4.0	2	1.0	10
LCFA201204A101TG	2012	0805	100(\pm 25%)	100	2.92	4.0	4	1.0	10

Test Conditions

- Common Mode Impedance (Ω): @100MHz
- DC Resistance (Ω): 25°C \pm 2°C
- Leakage Current (μ A): 5V
- Insulation Resistance (Max. $M\Omega$): 5V
- Rated Current (mA): 25°C \pm 2°C

Impedance Curves Common Mode

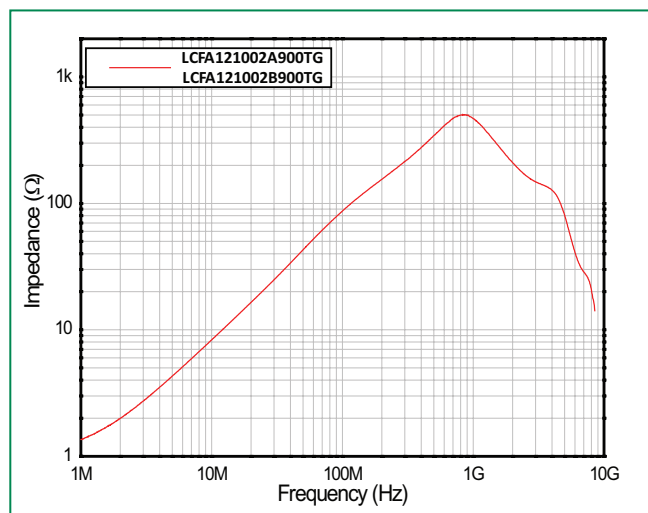

Differential Mode

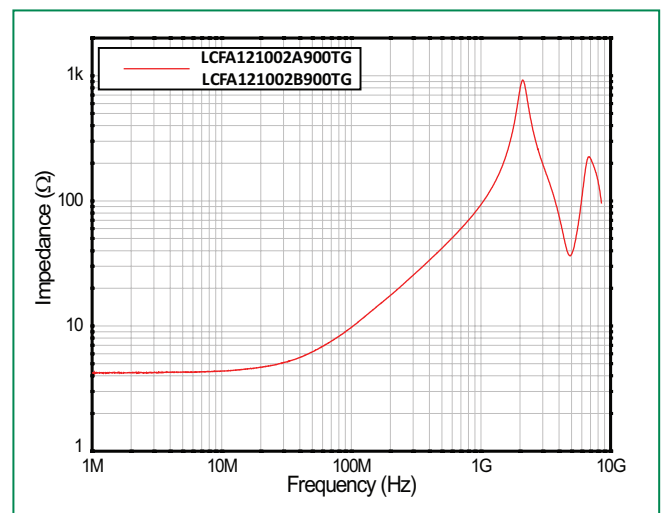

Transmission Characteristics (S-parameter) Common Mode S21

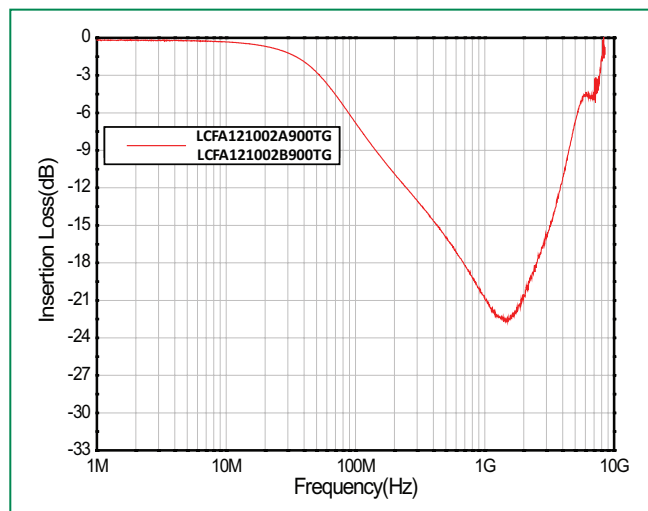

Differential Mode S21

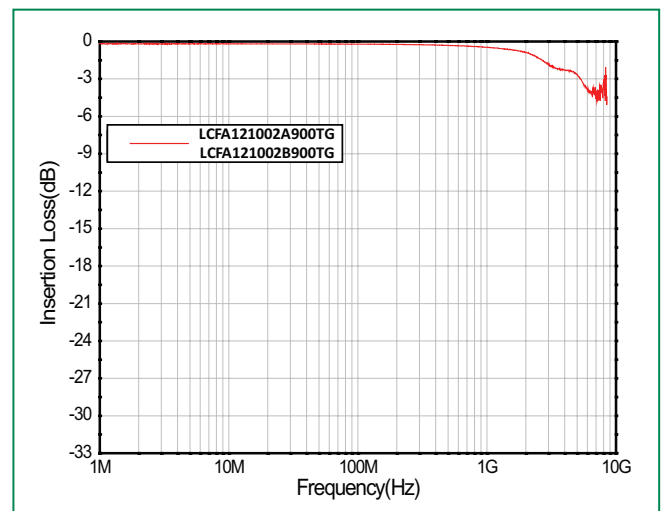

Impedance Curves
Common Mode

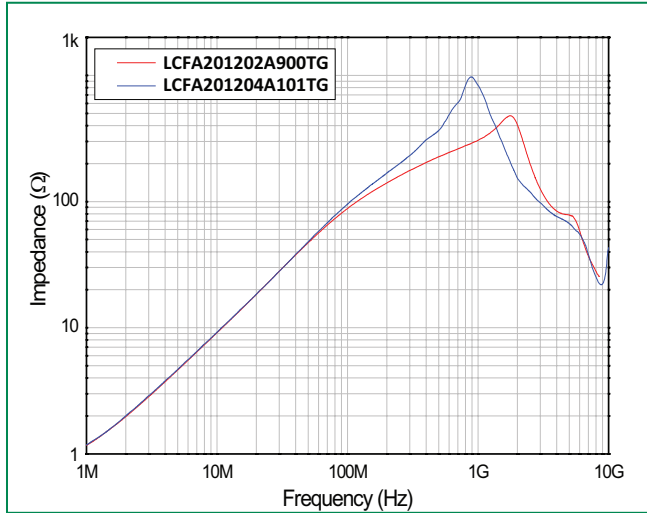

Differential Mode

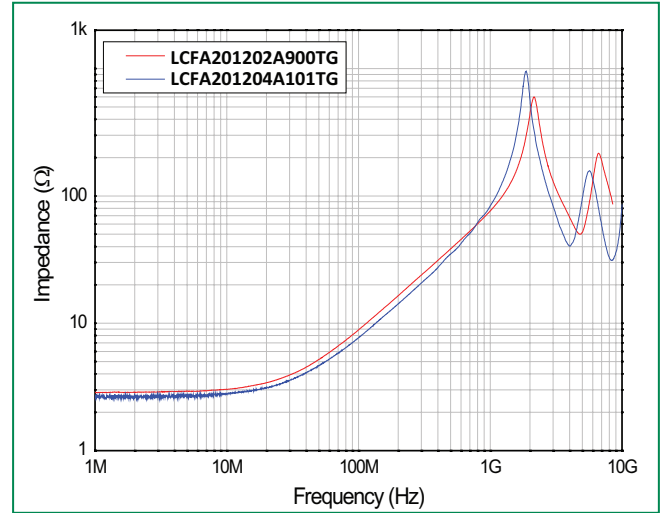

Transmission Characteristics (S-parameter)
Common Mode S21

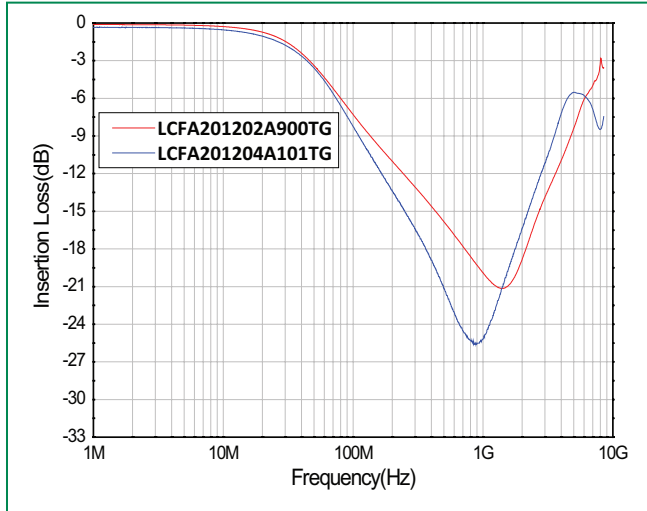

Differential Mode S21

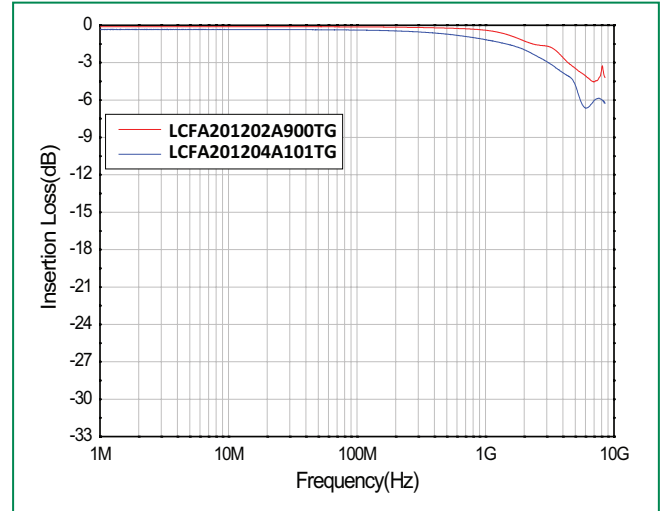

Soldering Parameters

Reflow Condition		Pb-free assembly
Pre Heat	- Temperature Min ($T_{s(min)}$)	160°C
	- Temperature Max ($T_{s(max)}$)	185°C
	- Time (Min to Max) (t_s)	100 – 120 seconds
Average Ramp-up Rate (Liquidus Temp (T_L) to peak)		1°C/second max
$T_{s(max)}$ to T_L - Ramp-up Rate		1°C/second max
Reflow	- Temperature (T_L) (Liquidus)	220°C
	- Temperature (t_L)	30 – 50 seconds
Peak Temperature (T_P)		260 ^{+0/-5} °C
Time within 5°C of actual peak Temperature (t_p)		5 – 10 seconds
Ramp-down Rate		2°C/second max
Time 25°C to Peak Temperature (T_P)		4 minutes max
Do not exceed		260°C
Wave Soldering		260°C, 10 sec. max

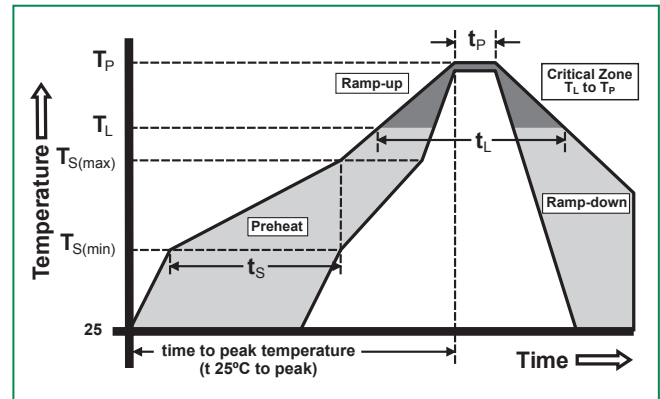

Recommended Soldering Profile (Lead free condition)

Product Characteristics

Lead Pull Strength	5N
Solderability	260°C, ≤10s (Reflow), Max 380°C, ≤5s (Soldering iron)
Soldering Heat Resistance	Max 260°C 10sec (Wave), Max Temperature: Max 380°C (Max 5sec)

Operating Temperature	-40°C to +125°C (consider re-rating)
Climatic Category	-40°C + 85°C/8 days
Stock Conditions	-10°C + 40°C RH , ≤ 70%
Vibration Resistance	5 g's for 20 minutes, 12 cycles each of three orientations

Dimensions

LCFA121002A900TG, LCFA121002B900TG

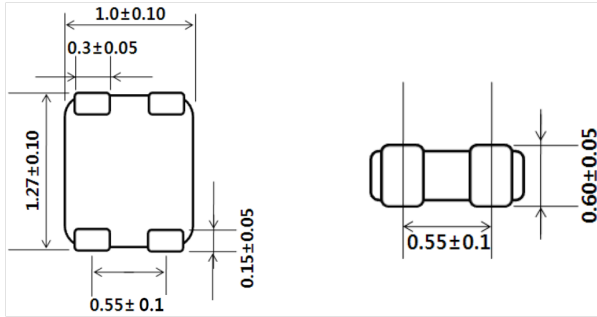

LCFA201202A900TG

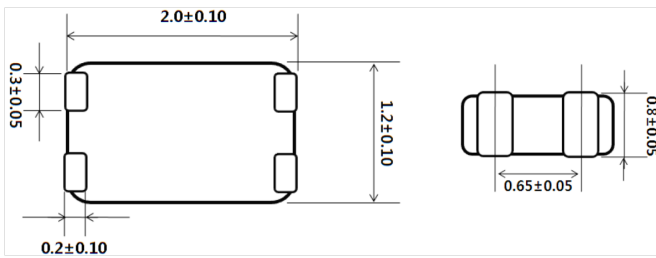

LCFA201204A101TG

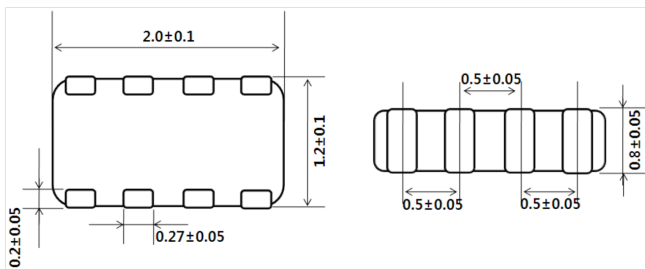

Recommended Footprint and Stencil Mask

Unit = mm

Stencil Mask T = 0.10mm

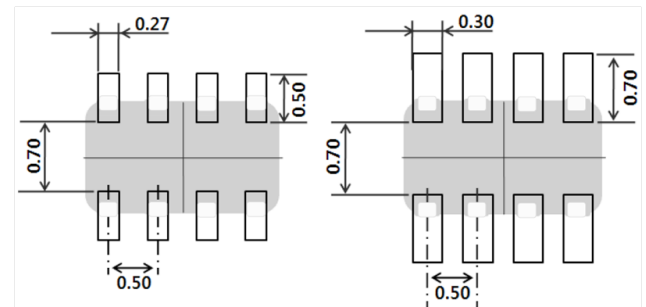
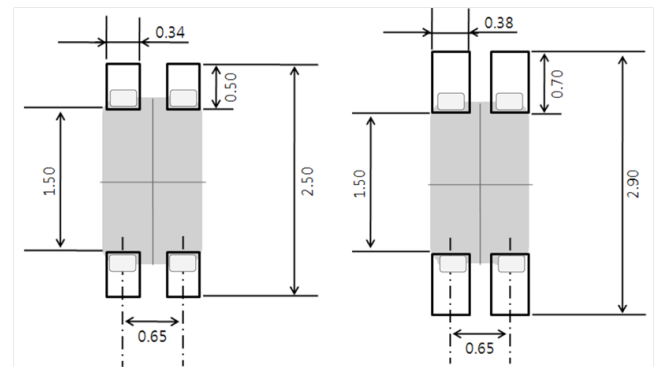
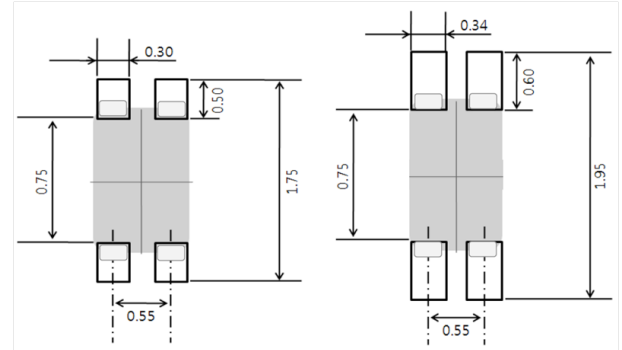

Carrie Tape Dimensions

LCFA121002A900TG, LCFA121002B900TG

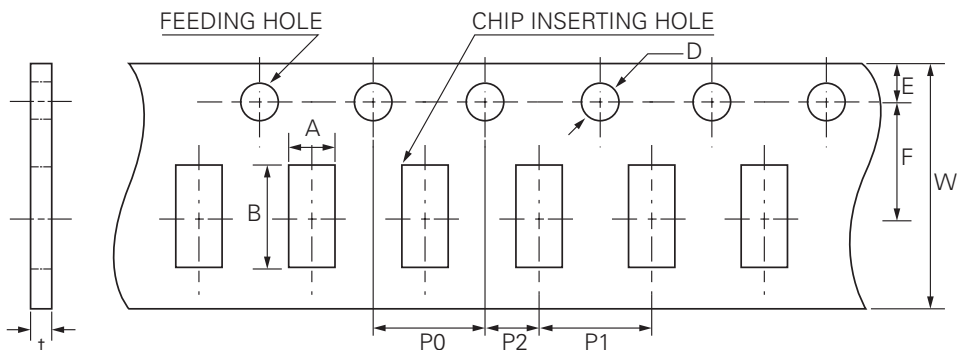

Symbol	Dimensions
	Millimeters
A	1.15±0.05
B	1.50±0.05
W	8.0+0.30, .0.10
F	3.50±0.05
E	1.75±0.05
P1	4.00±0.10
P2	2.00±0.05
P0	4.00±0.10
D	1.55±0.03
T	0.75±0.05

LCFA201202A900TG, LCFA201204A101TG

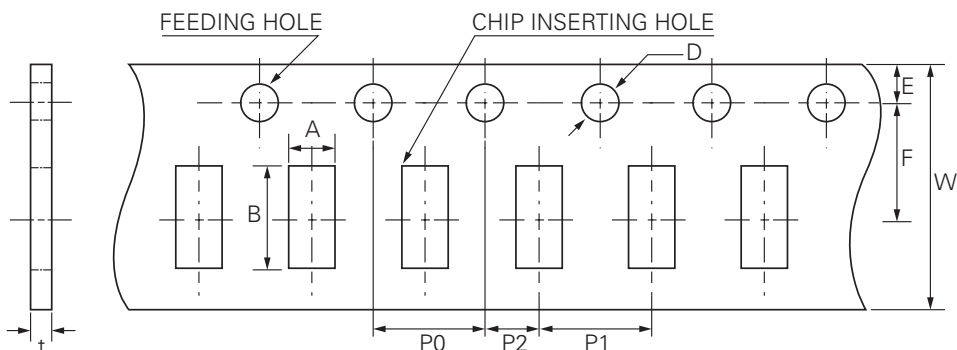

Symbol	Dimensions
	Millimeters
A	1.55±0.05
B	2.30±0.05
W	8.00±0.10
F	3.50±0.05
E	1.75±0.05
P1	4.00±0.10
P2	2.00±0.05
P0	4.00±0.10
D	1.55±0.03
T	0.95±0.05

Tape and Reel Dimension

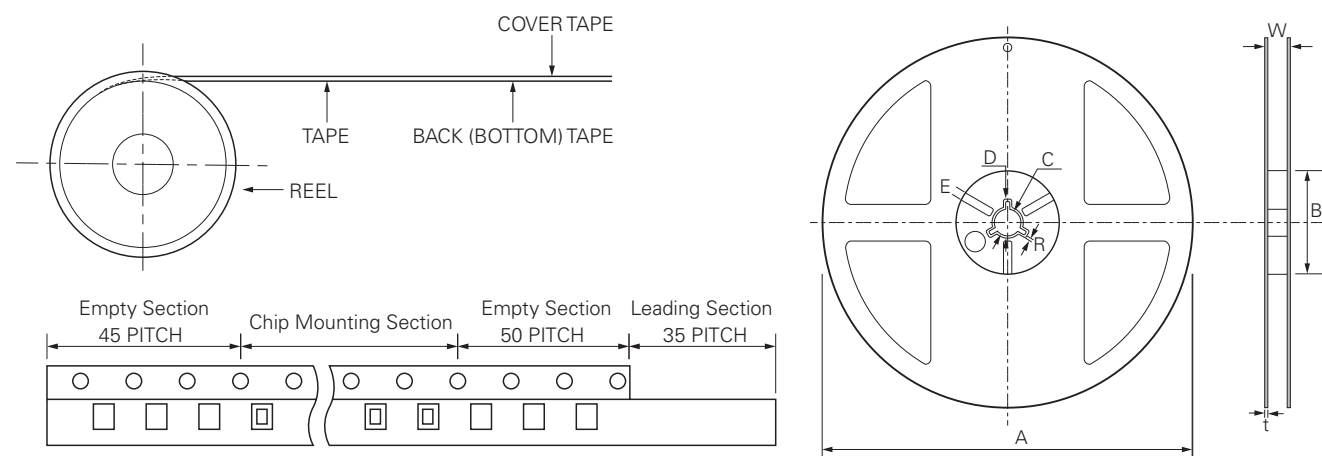

(1) Reel Materials: Polystyrene (2) Label (3) Taping
 - Standard Packing Quantity per Reel (Ø178)
 - PE Tape: 4,000pcs

Code	A	B	C	D	E	W	T	R
Dimension	Ø178±2	Min. Ø50	Ø13±0.5	Ø20±0.8	3.0±0.5	10±1.5	1.3±0.2	1.0±0.2

Part Numbering System

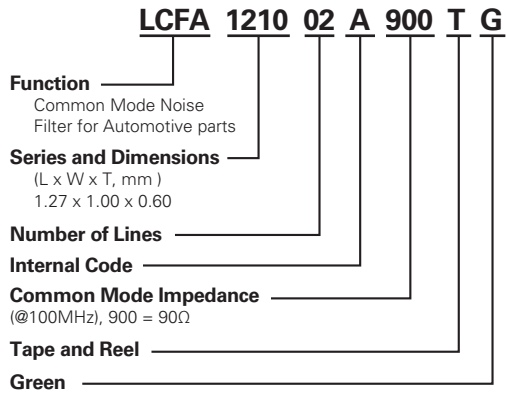

Ordering Information

Part Number	Reel Quantity
	4,000