

# Phase Control Thyristor

## Types N1718NC120 to N1718NC200

### Absolute Maximum Ratings

|                  | VOLTAGE RATINGS                                 | MAXIMUM LIMITS | UNITS |
|------------------|---|----------------|-------|
| V <sub>DRM</sub> | Repetitive peak off-state voltage, (note 1)     | 1200-2000      | V     |
| V <sub>DSM</sub> | Non-repetitive peak off-state voltage, (note 1) | 1200-2000      | V     |
| V <sub>RRM</sub> | Repetitive peak reverse voltage, (note 1)       | 1200-2000      | V     |
| V <sub>RSM</sub> | Non-repetitive peak reverse voltage, (note 1)   | 1300-2100      | V     |

|                       | OTHER RATINGS   | MAXIMUM LIMITS       | UNITS            |
|-----------------------|---|----------------------|------------------|
| I <sub>T(AV)M</sub>   | Maximum average on-state current, T <sub>sink</sub> =55°C, (note 2)                                       | 1718                 | A                |
| I <sub>T(AV)M</sub>   | Maximum average on-state current. T <sub>sink</sub> =85°C, (note 2)                                       | 1143                 | A                |
| I <sub>T(AV)M</sub>   | Maximum average on-state current. T <sub>sink</sub> =85°C, (note 3)                                       | 663                  | A                |
| I <sub>T(RMS)M</sub>  | Nominal RMS on-state current, T <sub>sink</sub> =25°C, (note 2)   | 3450                 | A                |
| I <sub>T(d.c.)</sub>  | D.C. on-state current, T <sub>sink</sub> =25°C, (note 4)  | 2852                 | A                |
| I <sub>TSM</sub>      | Peak non-repetitive surge t <sub>p</sub> =10ms, V <sub>m</sub> =0.6V <sub>RRM</sub> , (note 5)            | 27.2                 | kA               |
| I <sub>TSM2</sub>     | Peak non-repetitive surge t <sub>p</sub> =10ms, V <sub>m</sub> ≤10V, (note 5)                             | 29.9                 | kA               |
| I <sup>2</sup> t      | I <sup>2</sup> t capacity for fusing t <sub>p</sub> =10ms, V <sub>m</sub> =0.6V <sub>RRM</sub> , (note 5) | 3.70×10 <sup>6</sup> | A <sup>2</sup> s |
| I <sup>2</sup> t      | I <sup>2</sup> t capacity for fusing t <sub>p</sub> =10ms, V <sub>m</sub> ≤10V, (note 5)                  | 4.47×10 <sup>6</sup> | A <sup>2</sup> s |
| (di/dt) <sub>cr</sub> | Critical rate of rise of on-state current (repetitive), (Note 6)  | 500                  | A/μs             |
| (di/dt) <sub>cr</sub> | Critical rate of rise of on-state current (non-repetitive), (Note 6)                                      | 1000                 | A/μs             |
| V <sub>RGM</sub>      | Peak reverse gate voltage   | 5                    | V                |
| P <sub>G(AV)</sub>    | Mean forward gate power   | 4                    | W                |
| P <sub>GM</sub>       | Peak forward gate power   | 30                   | W                |
| T <sub>j op</sub>     | Operating temperature range   | -40 to +125          | °C               |
| T <sub>stg</sub>      | Storage temperature range   | -40 to +150          | °C               |

Notes:-

- 1) De-rating factor of 0.13% per °C is applicable for T<sub>j</sub> below 25°C.
- 2) Double side cooled, single phase; 50Hz, 180° half-sinewave.
- 3) Single side cooled, single phase; 50Hz, 180° half-sinewave.
- 4) Double side cooled.
- 5) Half-sinewave, 125°C T<sub>j</sub> initial.
- 6) V<sub>D</sub>=67% V<sub>DRM</sub>, I<sub>FG</sub>=2A, t<sub>r</sub>≤0.5μs, T<sub>case</sub>=125°C.

### Characteristics

|                | PARAMETER                                  | MIN. | TYP. | MAX.  | TEST CONDITIONS (Note 1)   | UNITS           |
|----------------|--|------|------|-------|--|-----------------|
| $V_{TM}$       | Maximum peak on-state voltage              | -    | -    | 1.41  | $I_{TM}=2550A$   | V               |
|                |  | -    | -    | 1.85  | $I_{TM}=5150A$   | V               |
| $V_{T0}$       | Threshold voltage                          | -    | -    | 0.979 |  | V               |
| $r_T$          | Slope resistance                           | -    | -    | 0.169 |  | m $\Omega$      |
| $(dv/dt)_{cr}$ | Critical rate of rise of off-state voltage | 1000 | -    | -     | $V_D=80\% V_{DRM}$ , linear ramp, gate o/c   | V/ $\mu$ s      |
| $I_{DRM}$      | Peak off-state current                     | -    | -    | 100   | Rated $V_{DRM}$  | mA              |
| $I_{RRM}$      | Peak reverse current                       | -    | -    | 100   | Rated $V_{RRM}$  | mA              |
| $V_{GT}$       | Gate trigger voltage                       | -    | -    | 3.0   | $T_j=25^\circ C$ $V_D=10V$ , $I_T=3A$  | V               |
| $I_{GT}$       | Gate trigger current                       | -    | -    | 300   |  | mA              |
| $V_{GD}$       | Gate non-trigger voltage                   | -    | -    | 0.25  |  | Rated $V_{DRM}$ |
| $I_H$          | Holding current                            | -    | -    | 1000  | $T_j=25^\circ C$   | mA              |
| $t_{gd}$       | Gate-controlled turn-on delay time         | -    | 0.6  | 1.5   | $V_D=67\% V_{DRM}$ , $I_T=1500A$ , $di/dt=10A/\mu s$ ,<br>$I_{FG}=2A$ , $t_r=0.5\mu s$ , $T_j=25^\circ C$            | $\mu$ s         |
| $t_{gt}$       | Turn-on time                               | -    | 1.1  | 2.5   |  | $\mu$ s         |
| $Q_{rr}$       | Recovered charge                           | -    | 2300 | 2550  | $I_{TM}=1000A$ , $t_p=1000\mu s$ , $di/dt=10A/\mu s$ ,<br>$V_r=50V$  | $\mu$ C         |
| $Q_{ra}$       | Recovered charge, 50% Chord                | -    | 1500 | -     |  | $\mu$ C         |
| $I_{rr}$       | Reverse recovery current                   | -    | 123  | -     |  | A               |
| $t_{rr}$       | Reverse recovery time                      | -    | 24   | -     |  | $\mu$ s         |
| $t_q$          | Turn-off time                              | -    | 100  | -     | $I_{TM}=1000A$ , $t_p=1000\mu s$ , $di/dt=10A/\mu s$ ,<br>$V_r=50V$ , $V_{dr}=80\%V_{DRM}$ , $dV_{dr}/dt=20V/\mu s$  | $\mu$ s         |
|                |  | -    | 170  | -     | $I_{TM}=1000A$ , $t_p=1000\mu s$ , $di/dt=10A/\mu s$ ,<br>$V_r=50V$ , $V_{dr}=80\%V_{DRM}$ , $dV_{dr}/dt=200V/\mu s$ | $\mu$ s         |
| $R_{thJK}$     | Thermal resistance, junction to heatsink   | -    | -    | 0.024 | Double side cooled   | K/W             |
|                |  | -    | -    | 0.048 | Single side cooled   | K/W             |
| F              | Mounting force                             | 19   | -    | 26    |  | kN              |
| $W_t$          | Weight                                     | -    | 510  | -     |  | g               |

Notes:-

- 1) Unless otherwise indicated  $T_j=125^\circ C$ .
- 2) For other clamp forces please consult factory.

## Notes on Ratings and Characteristics

### 1.0 Voltage Grade Table

| Voltage Grade | $V_{DRM}$ $V_{DSM}$ $V_{RRM}$<br>V | $V_{RSM}$<br>V | $V_D$ $V_R$<br>DC V |
|---------------|------------------------------------|----------------|---------------------|
| 12            | 1200                               | 1300           | 810                 |
| 14            | 1400                               | 1500           | 930                 |
| 16            | 1600                               | 1700           | 1040                |
| 18            | 1800                               | 1900           | 1150                |
| 20            | 2000                               | 2100           | 1270                |

### 2.0 Extension of Voltage Grades

This report is applicable to other voltage grades when supply has been agreed by Sales/Production.

### 3.0 De-rating Factor

A blocking voltage de-rating factor of 0.13%/°C is applicable to this device for  $T_j$  below 25°C.

### 4.0 Repetitive dv/dt

Standard dv/dt is 1000V/μs.

### 5.0 Snubber Components

When selecting snubber components, care must be taken not to use excessively large values of snubber capacitor or excessively small values of snubber resistor. Such excessive component values may lead to device damage due to the large resultant values of snubber discharge current. If required, please consult the factory for assistance.

### 6.0 Rate of rise of on-state current

The maximum un-primed rate of rise of on-state current must not exceed 1000A/μs at any time during turn-on on a non-repetitive basis. For repetitive performance, the on-state rate of rise of current must not exceed 500A/μs at any time during turn-on. Note that these values of rate of rise of current apply to the total device current including that from any local snubber network.

### 7.0 Gate Drive

The nominal requirement for a typical gate drive is illustrated below. An open circuit voltage of at least 30V is assumed. This gate drive must be applied when using the full di/dt capability of the device.

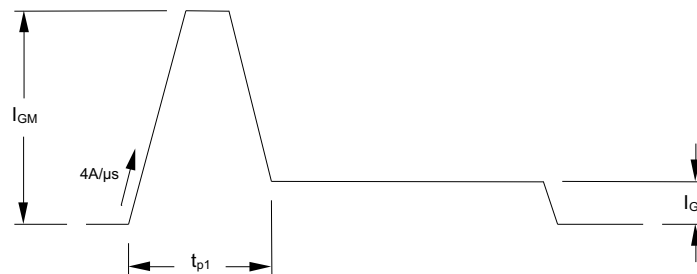

The magnitude of  $I_{GM}$  should be between five and ten times  $I_{GT}$ , which is shown on page 2. Its duration ( $t_{p1}$ ) should be 20μs or sufficient to allow the anode current to reach ten times  $I_L$ , whichever is greater. Otherwise, an increase in pulse current could be needed to supply the necessary charge to trigger. The 'back-porch' current  $I_G$  should remain flowing for the same duration as the anode current and have a magnitude in the order of 1.5 times  $I_{GT}$ .

## 8.0 Computer Modelling Parameters

### 8.1 Device Dissipation Calculations

$$I_{AV} = \frac{-V_{T0} + \sqrt{V_{T0}^2 + 4 \cdot ff^2 \cdot r_T \cdot W_{AV}}}{2 \cdot ff^2 \cdot r_T}$$

and:

$$W_{AV} = \frac{\Delta T}{R_{th}}$$

$$\Delta T = T_{j\max} - T_K$$

Where  $V_{T0}=0.979V$ ,  $r_T=0.169m\Omega$ ,

$R_{th}$  = Supplementary thermal impedance, see table below and

$ff$  = Form factor, see table below.

| Supplementary Thermal Impedance |        |        |        |        |        |        |       |
|---------------------------------|--------|--------|--------|--------|--------|--------|-------|
| Conduction Angle                | 30°    | 60°    | 90°    | 120°   | 180°   | 270°   | d.c.  |
| Square wave Double Side Cooled  | 0.0293 | 0.0285 | 0.0278 | 0.0271 | 0.0261 | 0.0249 | 0.024 |
| Square wave Single Side Cooled  | 0.0534 | 0.053  | 0.0524 | 0.0518 | 0.0509 | 0.0497 | 0.048 |
| Sine wave Double Side Cooled    | 0.0286 | 0.0276 | 0.0269 | 0.0263 | 0.0248 |        |       |
| Sine wave Single Side Cooled    | 0.0531 | 0.0523 | 0.0517 | 0.0511 | 0.0497 |        |       |

| Form Factors     |       |       |      |       |       |       |      |
|------------------|-------|-------|------|-------|-------|-------|------|
| Conduction Angle | 30°   | 60°   | 90°  | 120°  | 180°  | 270°  | d.c. |
| Square wave      | 3.464 | 2.449 | 2    | 1.732 | 1.414 | 1.149 | 1    |
| Sine wave        | 3.98  | 2.778 | 2.22 | 1.879 | 1.57  |       |      |

### 8.2 Calculating $V_T$ using ABCD Coefficients

The on-state characteristic  $I_T$  vs.  $V_T$ , on page 6 is represented in two ways;

- the well established  $V_{T0}$  and  $r_T$  tangent used for rating purposes and
- a set of constants A, B, C, D, forming the coefficients of the representative equation for  $V_T$  in terms of  $I_T$  given below:

$$V_T = A + B \cdot \ln(I_T) + C \cdot I_T + D \cdot \sqrt{I_T}$$

The constants, derived by curve fitting software, are given below for both hot and cold characteristics. The resulting values for  $V_T$  agree with the true device characteristic over a current range, which is limited to that plotted.

| 25°C Coefficients |                           | 125°C Coefficients |                         |
|-------------------|---------------------------|--------------------|-------------------------|
| A                 | 0.7637538                 | A                  | 0.5497078               |
| B                 | 0.03561525                | B                  | 0.067655                |
| C                 | $1.11447 \times 10^{-4}$  | C                  | $1.6257 \times 10^{-4}$ |
| D                 | $1.837515 \times 10^{-3}$ | D                  | $-1.682 \times 10^{-3}$ |

8.3 D.C. Thermal Impedance Calculation

$$r_t = \sum_{p=1}^{p=n} r_p \cdot \left( 1 - e^{-\frac{t}{\tau_p}} \right)$$

Where  $p = 1$  to  $n$ ,  $n$  is the number of terms in the series and:

- $t$  = Duration of heating pulse in seconds.
- $r_t$  = Thermal resistance at time  $t$ .
- $r_p$  = Amplitude of  $p$ th term.
- $\tau_p$  = Time Constant of  $r$ th term.

The coefficients for this device are shown in the tables below:

| D.C. Double Side Cooled |            |                           |                           |                           |                           |
|-------------------------|------------|---------------------------|---------------------------|---------------------------|---------------------------|
| Term                    | 1          | 2                         | 3                         | 4                         | 5                         |
| $r_p$                   | 0.01249139 | $6.316833 \times 10^{-3}$ | $1.850855 \times 10^{-3}$ | $1.922045 \times 10^{-3}$ | $6.135330 \times 10^{-4}$ |
| $\tau_p$                | 0.8840810  | 0.1215195                 | 0.03400152                | $6.742908 \times 10^{-3}$ | $1.326292 \times 10^{-3}$ |

| D.C. Single Side Cooled |            |                           |                           |                           |                           |                           |
|-------------------------|------------|---------------------------|---------------------------|---------------------------|---------------------------|---------------------------|
| Term                    | 1          | 2                         | 3                         | 4                         | 5                         | 6                         |
| $r_p$                   | 0.02919832 | $4.863568 \times 10^{-3}$ | $3.744798 \times 10^{-3}$ | $6.818034 \times 10^{-3}$ | $2.183558 \times 10^{-3}$ | $1.848294 \times 10^{-3}$ |
| $\tau_p$                | 6.298105   | 3.286174                  | 0.5359179                 | 0.1186897                 | 0.02404574                | $3.379476 \times 10^{-3}$ |

9.0 Reverse recovery ratings

(i)  $Q_{ra}$  is based on 50%  $I_{RM}$  chord as shown in Fig. 1

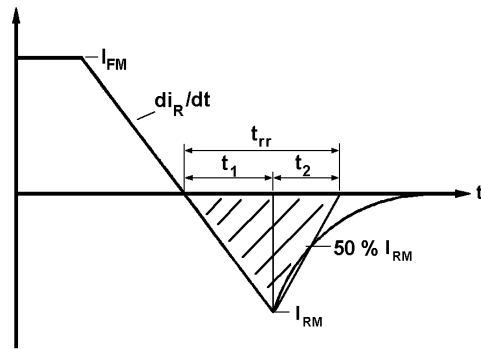

Fig. 1

(ii)  $Q_{rr}$  is based on a  $150\mu s$  integration time i.e.

$$Q_{rr} = \int_0^{150\mu s} i_{rr} \cdot dt$$

(iii)  $K \text{ Factor} = \frac{t_1}{t_2}$

**Curves**

Figure 1 - On-state characteristics of Limit device

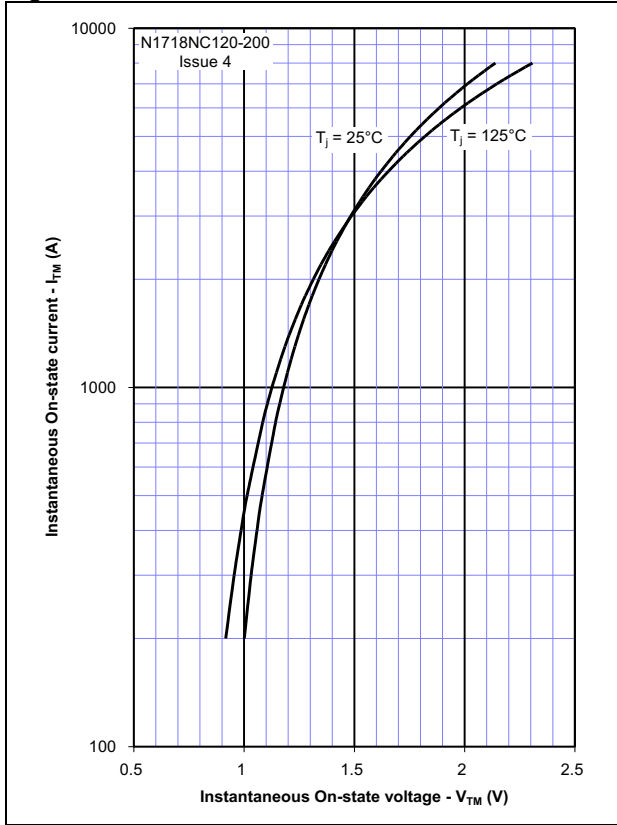

Figure 2 - Transient thermal impedance

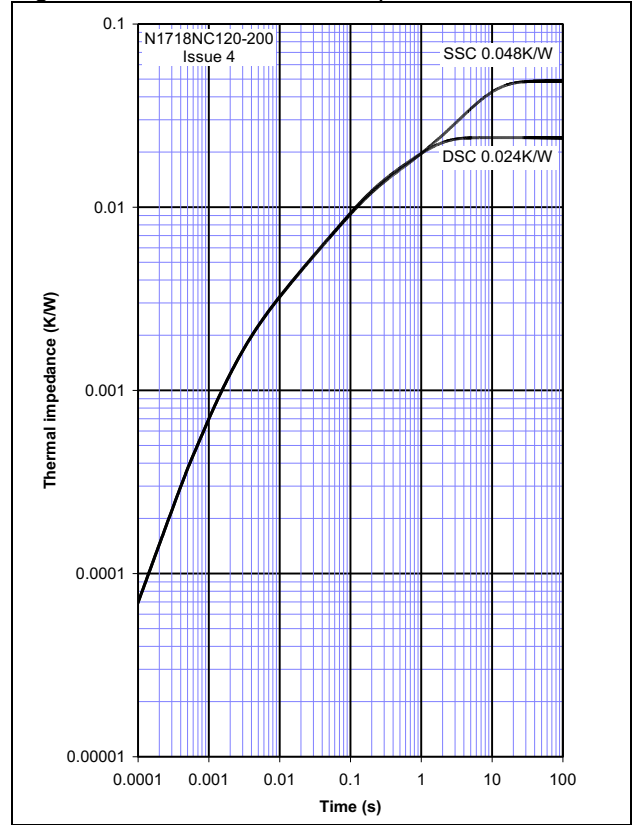

Figure 3 - Gate characteristics - Trigger limits

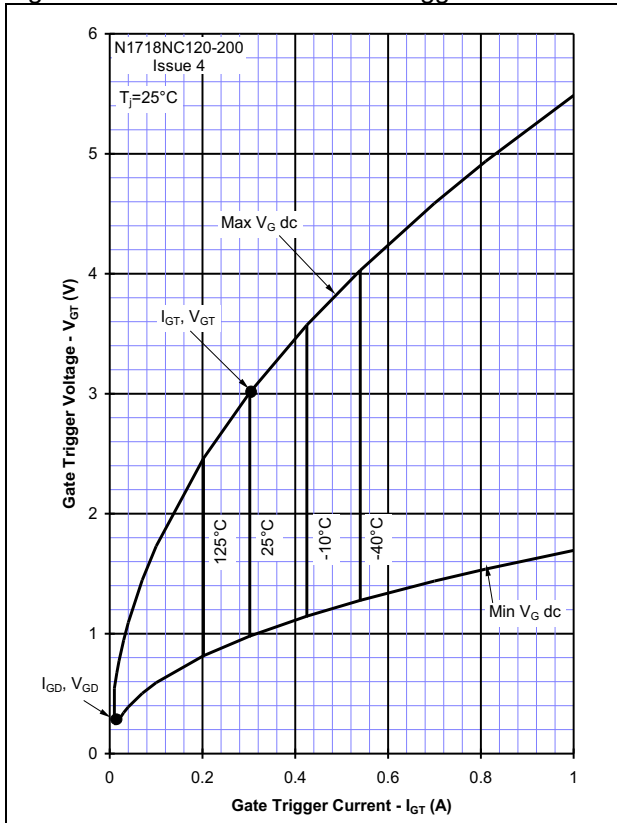

Figure 4 - Gate characteristics - Power curves

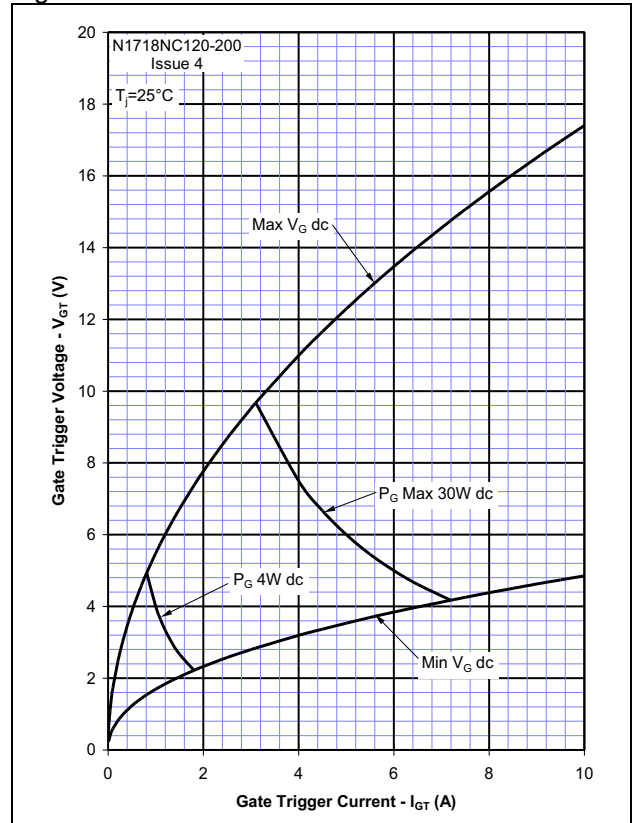

Figure 5 - Total recovered charge,  $Q_{rr}$

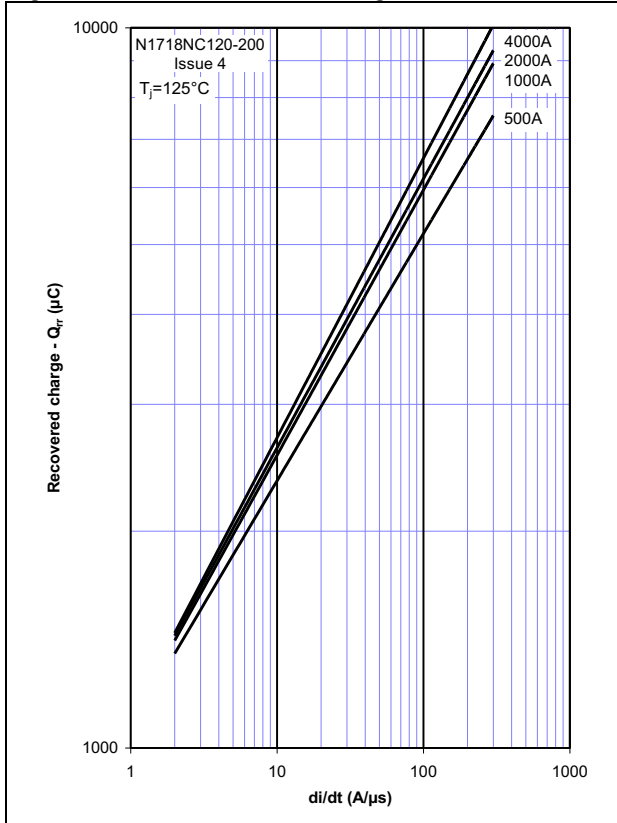

Figure 6 - Recovered charge,  $Q_{ra}$  (50% chord)

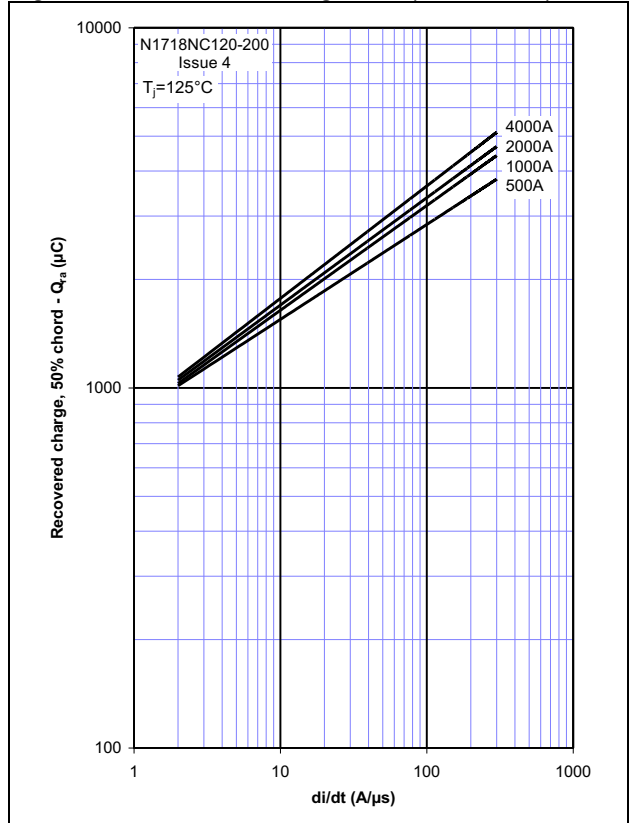

Figure 7 - Peak reverse recovery current,  $I_{rm}$

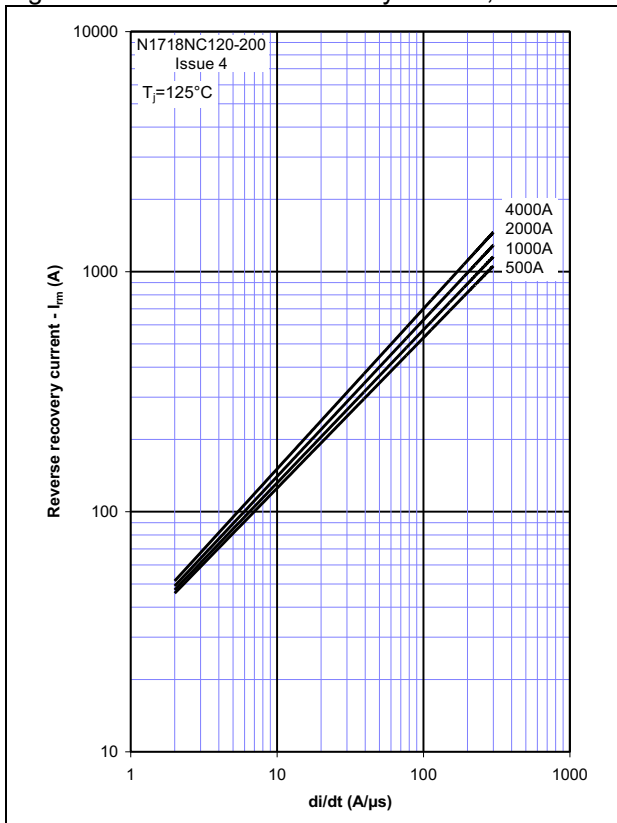

Figure 8 - Maximum recovery time,  $t_{rr}$  (50% chord)

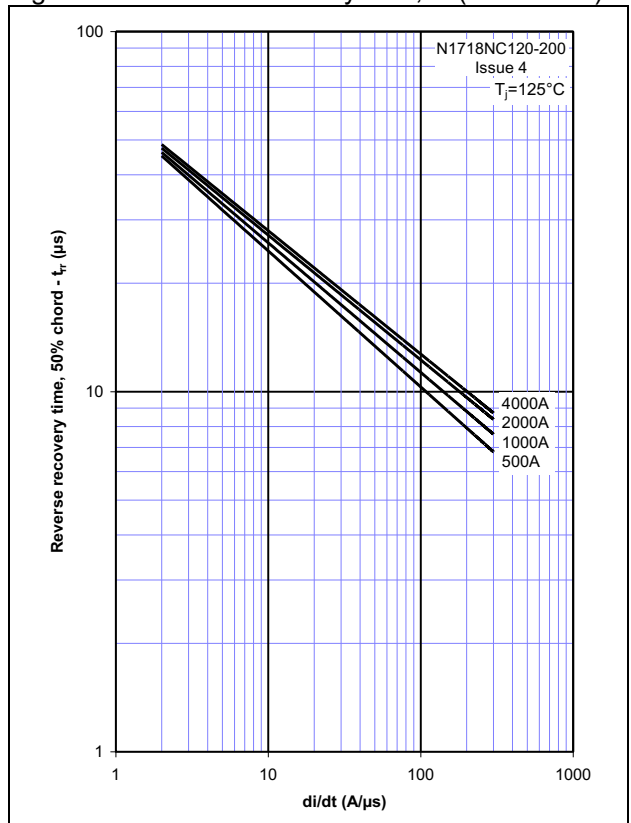

Figure 9 – On-state current vs. Power dissipation – Double Side Cooled (Sine wave)

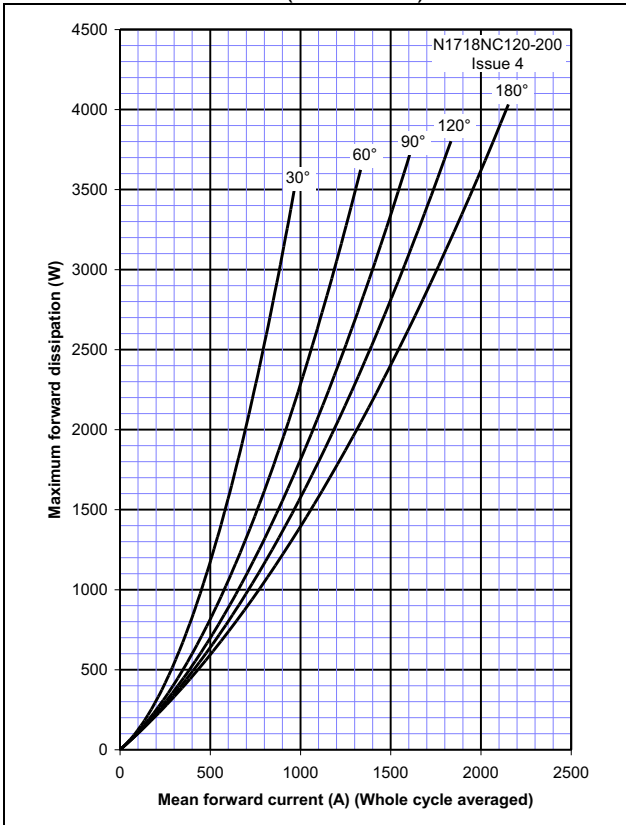

Figure 10 – On-state current vs. Heatsink temperature - Double Side Cooled (Sine wave)

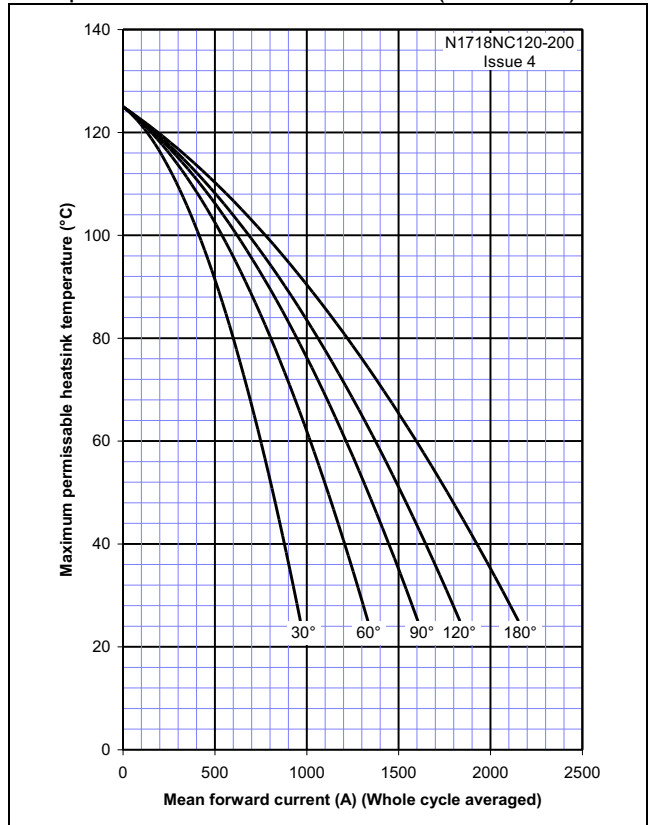

Figure 11 – On-state current vs. Power dissipation – Double Side Cooled (Square wave)

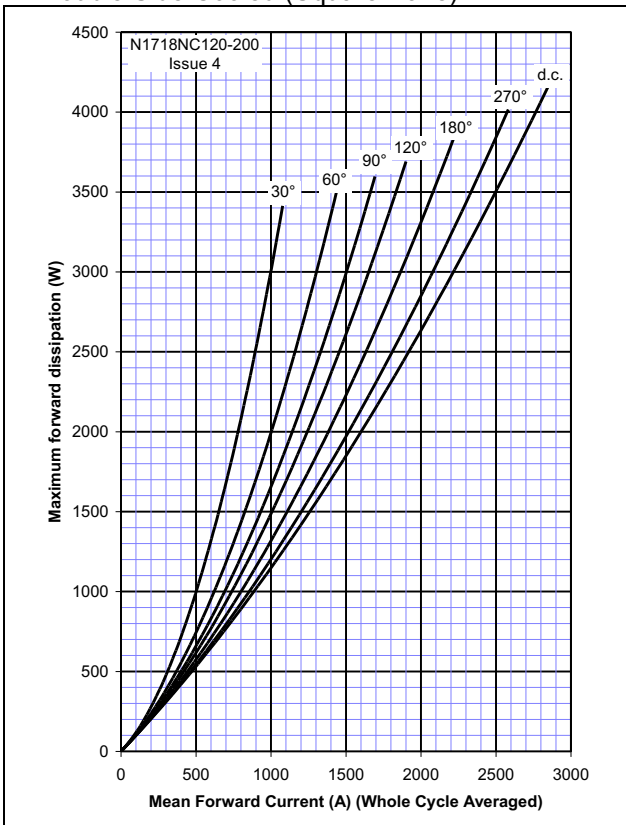

Figure 12 – On-state current vs. Heatsink temperature – Double Side Cooled (Square wave)

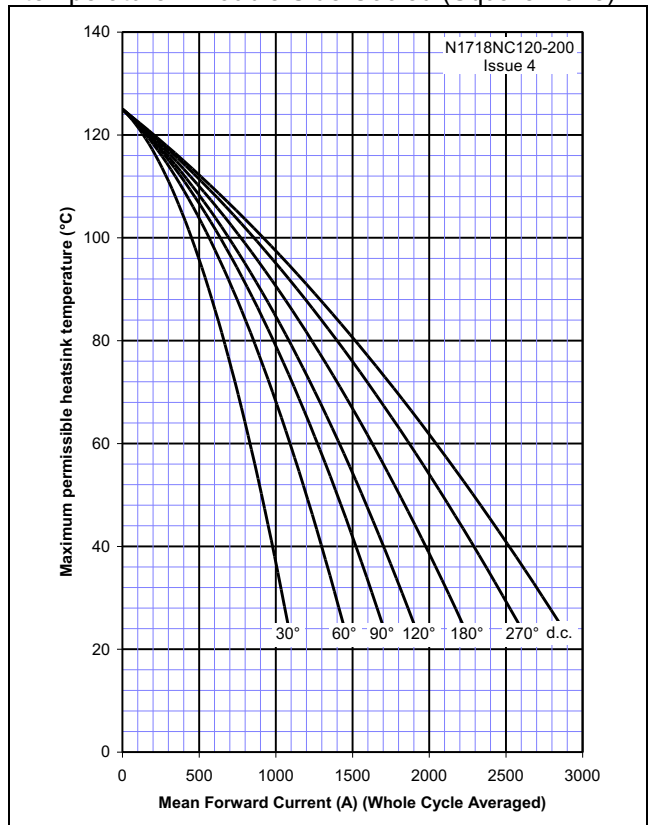



Figure 13 – On-state current vs. Power dissipation – Single Side Cooled (Sine wave)

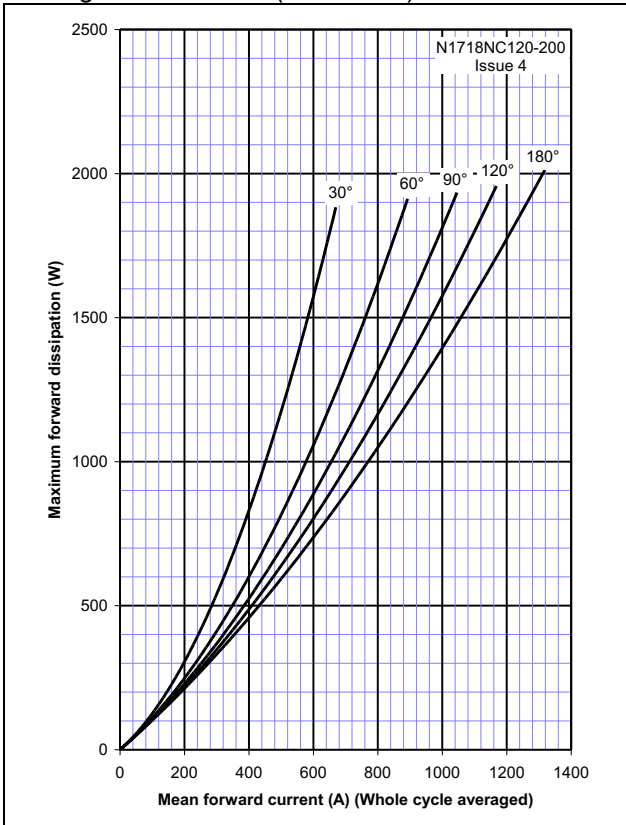

Figure 14 – On-state current vs. Heatsink temperature – Single Side Cooled (Sine wave)

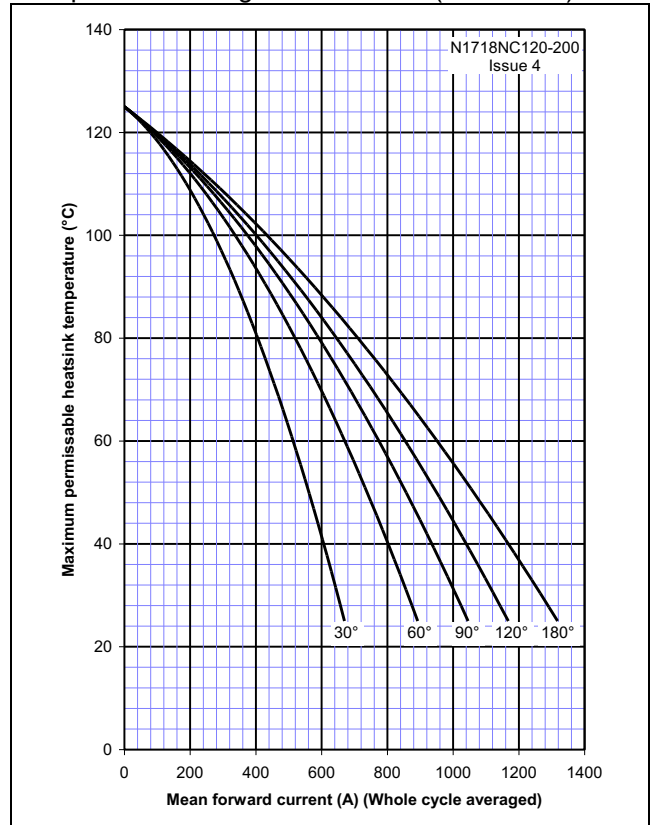

Figure 15 – On-state current vs. Power dissipation – Single Side Cooled (Square wave)

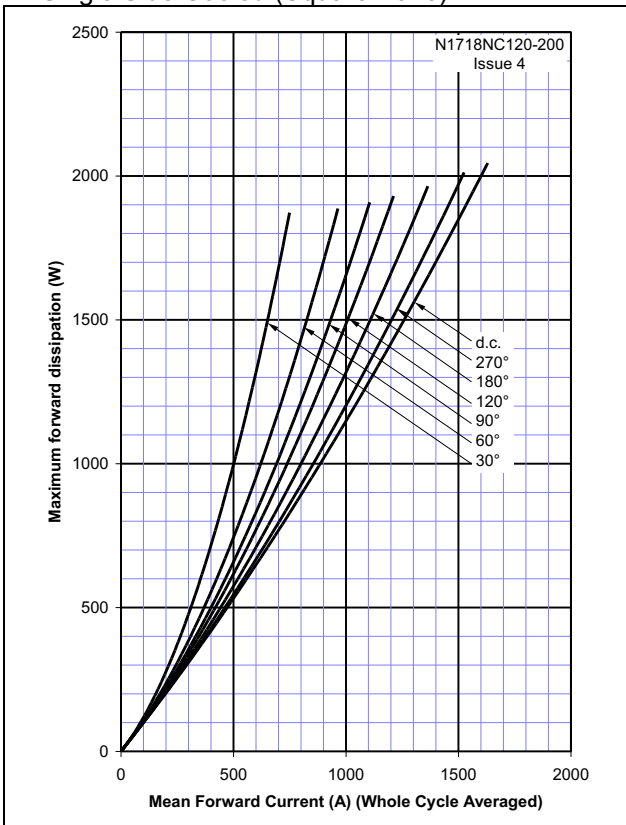

Figure 16 – On-state current vs. Heatsink temperature – Single Side Cooled (Square wave)

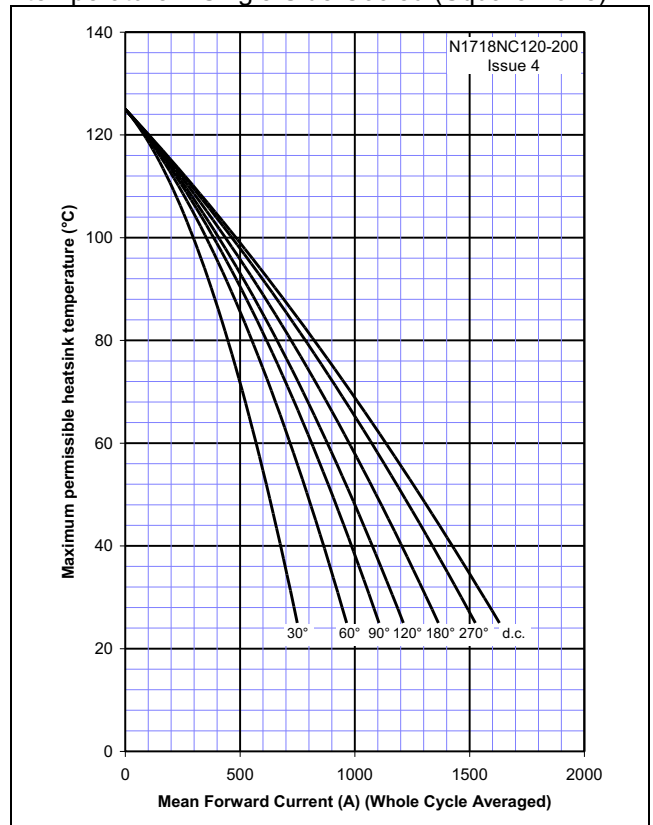
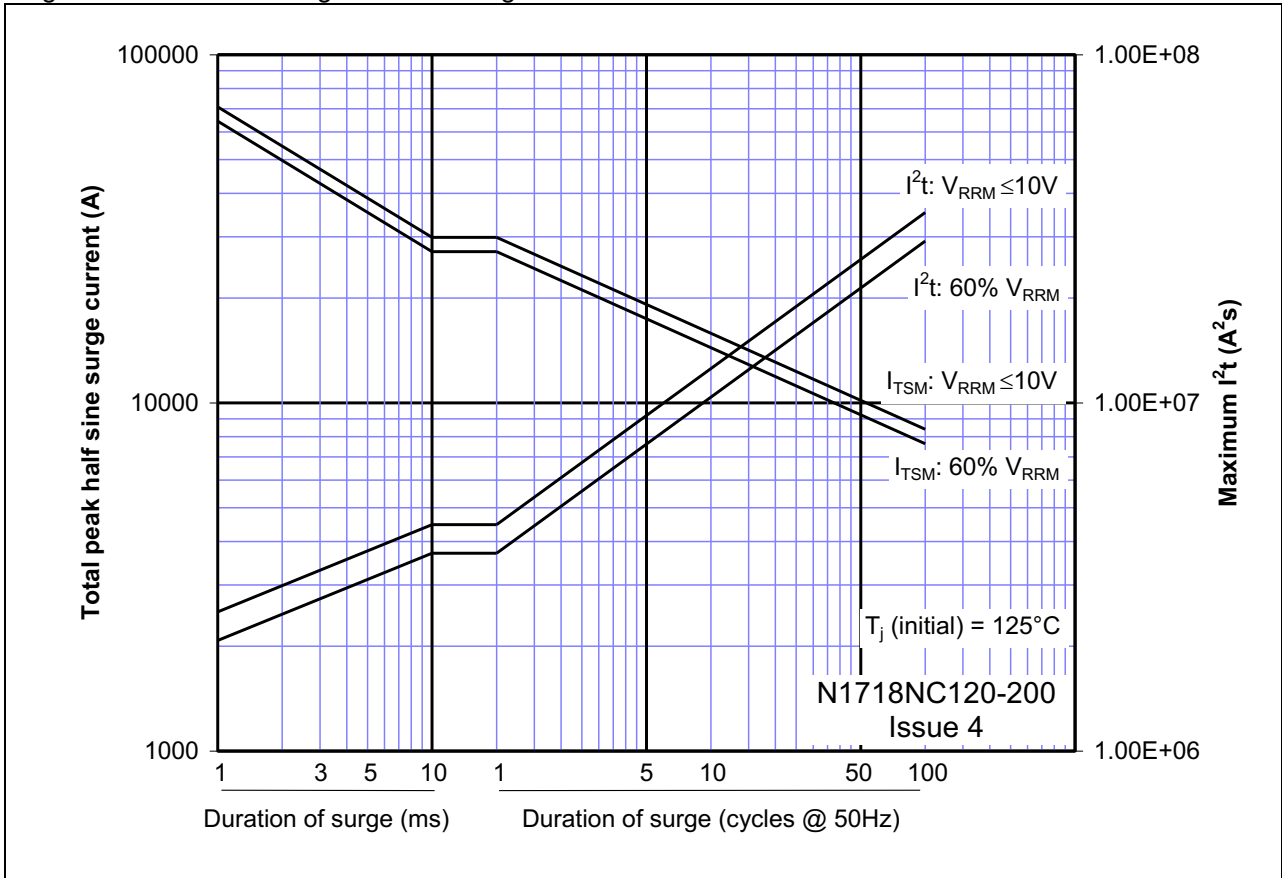
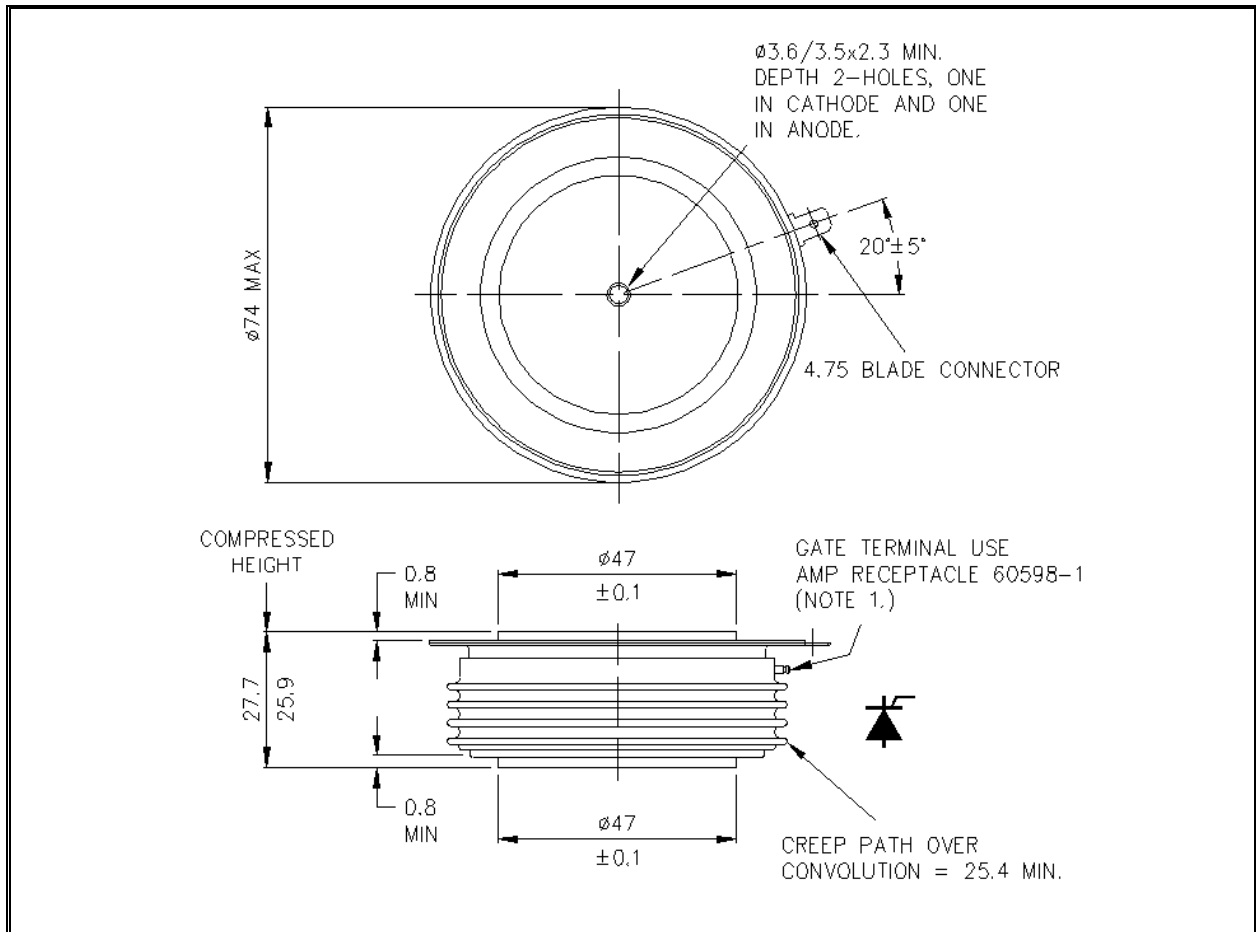

Figure 17 - Maximum surge and  $I^2t$  Ratings



**Outline Drawing & Ordering Information**



101A223

| ORDERING INFORMATION                  |                    |  |                          |
|---------------------------------------|--------------------|--|--------------------------|
| (Please quote 10 digit code as below) |                    |  |                          |
| <b>N1718</b>                          | <b>NC</b>          | <b>◆◆</b>                              | <b>◆</b>                 |
| Fixed Type Code                       | Fixed outline code | Voltage code<br>$V_{DRM}/100$<br>12-20 | Fixed turn-off time code |

Order code: N1718NC200 – 2000V  $V_{DRM}$ ,  $V_{RRM}$ , 26.6mm clamp height capsule.

**IXYS Semiconductor GmbH**  
Edisonstraße 15  
D-68623 Lampertheim  
Tel: +49 6206 503-0  
Fax: +49 6206 503-627  
E-mail: [marcom@ixys.de](mailto:marcom@ixys.de)



**IXYS UK Westcode Ltd**  
Langley Park Way, Langley Park,  
Chippenham, Wiltshire, SN15 1GE.  
Tel: +44 (0)1249 444524  
Fax: +44 (0)1249 659448  
E-mail: [sales@ixysuk.com](mailto:sales@ixysuk.com)

**IXYS Corporation**  
1590 Buckeye Drive  
Milpitas CA 95035-7418  
Tel: +1 (408) 457 9000  
Fax: +1 (408) 496 0670  
E-mail: [sales@ixys.net](mailto:sales@ixys.net)

[www.ixysuk.com](http://www.ixysuk.com)

[www.ixys.com](http://www.ixys.com)

**IXYS Long Beach**  
IXYS Long Beach, Inc  
2500 Mira Mar Ave, Long Beach  
CA 90815  
Tel: +1 (562) 296 6584  
Fax: +1 (562) 296 6585  
E-mail: [service@ixyslongbeach.com](mailto:service@ixyslongbeach.com)

The information contained herein is confidential and is protected by Copyright. The information may not be used or disclosed except with the written permission of and in the manner permitted by the proprietors IXYS UK Westcode Ltd.

© IXYS UK Westcode Ltd.

In the interest of product improvement, IXYS UK Westcode Ltd reserves the right to change specifications at any time without prior notice.

Devices with a suffix code (2-letter or letter/digit/letter combination) added to their generic code are not necessarily subject to the conditions and limits contained in this report.



---

Disclaimer Notice - Information furnished is believed to be accurate and reliable. However, users should independently evaluate the suitability of and test each product selected for their own applications. Littelfuse products are not designed for, and may not be used in, all applications. Read complete Disclaimer Notice at [www.littelfuse.com/disclaimer-electronics](http://www.littelfuse.com/disclaimer-electronics).