



**IXYS**  
A Littelfuse Technology

 Date: - 26<sup>th</sup> April 2022

Data Sheet Issue: - A1

# Medium Voltage Thyristor

## Types K4005EA480 and K4005EA520

### Absolute Maximum Ratings

	VOLTAGE RATINGS	MAXIMUM LIMITS	UNITS
V <sub>DRM</sub>	Repetitive peak off-state voltage, (note 1)	4800-5200	V
V <sub>DSM</sub>	Non-repetitive peak off-state voltage, (note 1)	4800-5200	V
V <sub>RRM</sub>	Repetitive peak reverse voltage, (note 1)	4800-5200	V
V <sub>RSM</sub>	Non-repetitive peak reverse voltage, (note 1)	4900-5300	V

	OTHER RATINGS	MAXIMUM LIMITS	UNITS
I <sub>T(AV)</sub>	Mean on-state current. T <sub>sink</sub> =55°C, (note 2)	4200	A
I <sub>T(AV)</sub>	Mean on-state current. T <sub>sink</sub> =85°C, (note 2)	2965	A
I <sub>T(AV)</sub>	Mean on-state current. T <sub>sink</sub> =85°C, (note 3)	1650	A
I <sub>T(RMS)</sub>	Nominal RMS on-state current. T <sub>sink</sub> =25°C, (note 2)	8165	A
I <sub>T(d.c.)</sub>	D.C. on-state current. T <sub>sink</sub> =25°C, (note 4)	7380	A
I <sub>TSM</sub>	Peak non-repetitive surge t <sub>p</sub> =10ms, V <sub>RM</sub> =0.6V <sub>RRM</sub> , (note 5)	43.2	kA
I <sub>TSM2</sub>	Peak non-repetitive surge t <sub>p</sub> =10ms, V <sub>RM</sub> ≤10V, (note 5)	47.5	kA
I <sup>2</sup> t	I <sup>2</sup> t capacity for fusing t <sub>p</sub> =10ms, V <sub>RM</sub> =0.6V <sub>RRM</sub> , (note 5)	9.33×10 <sup>6</sup>	A <sup>2</sup> s
I <sup>2</sup> t	I <sup>2</sup> t capacity for fusing t <sub>p</sub> =10ms, V <sub>RM</sub> ≤10V, (note 5)	10.26×10 <sup>6</sup>	A <sup>2</sup> s
di <sub>T</sub> /dt	Maximum rate of rise of on-state current (continuous), (Note 6)	200	A/μs
	Maximum rate of rise of on-state current (repetitive), (Note 6)	400	A/μs
	Maximum rate of rise of on-state current (non-repetitive), (Note 6)	1000	A/μs
V <sub>RGM</sub>	Peak reverse gate voltage	5	V
P <sub>G(AV)</sub>	Mean forward gate power	4	W
P <sub>GM</sub>	Peak forward gate power	50	W
V <sub>GD</sub>	Non-trigger gate voltage, (Note 7)	0.25	V
T <sub>HS</sub>	Operating temperature range	-40 to +125	°C
T <sub>stg</sub>	Storage temperature range	-40 to +150	°C

Notes: -

- 1) De-rating factor of 0.13% per °C is applicable for T<sub>j</sub> below 25°C.
- 2) Double side cooled, single phase; 50Hz, 180° half-sinewave.
- 3) Cathode side cooled, single phase; 50Hz, 180° half-sinewave.
- 4) Double side cooled.
- 5) Half-sinewave, 125°C T<sub>j</sub> initial.
- 6) V<sub>D</sub>=67% V<sub>DRM</sub>, I<sub>TM</sub>=7400A, I<sub>FG</sub>=2A, t<sub>r</sub>≤0.5μs, T<sub>case</sub>=125°C.
- 7) Rated V<sub>DRM</sub>.

## Characteristics

	PARAMETER	MIN.	TYP.	MAX.	TEST CONDITIONS (Note 1)	UNITS
V <sub>TM</sub>	Maximum peak on-state voltage	-	-	2.0	I <sub>TM</sub> =4000A	V
V <sub>0</sub>	Threshold voltage	-	-	1.168		V
r <sub>s</sub>	Slope resistance	-	-	0.209		mΩ
dv/dt	Critical rate of rise of off-state voltage	1000	-	-	V <sub>D</sub> =80% V <sub>DRM</sub> , Linear ramp, gate o/c	V/μs
I <sub>DRM</sub>	Peak off-state current	-	-	200	Rated V <sub>DRM</sub>	mA
I <sub>RRM</sub>	Peak reverse current	-	-	200	Rated V <sub>RRM</sub>	mA
V <sub>GT</sub>	Gate trigger voltage	-	-	3.0	T <sub>J</sub> =25°C, V <sub>D</sub> =10V, I <sub>T</sub> =3A	V
I <sub>GT</sub>	Gate trigger current	-	-	300		mA
I <sub>H</sub>	Holding current	-	-	1000	T <sub>J</sub> =25°C	mA
t <sub>gd</sub>	Gate controlled turn-on delay time	-	2.2	3.0	I <sub>FG</sub> =2A, t <sub>r</sub> =0.5μs, V <sub>D</sub> =60%V <sub>DRM</sub> , I <sub>TM</sub> =2000A, di/dt=10A/μs, T <sub>J</sub> =25°C	μs
t <sub>gt</sub>	Turn-on time	-	2.8	5.0		
Q <sub>rr</sub>	Recovered Charge	-	13500	18000		μC
Q <sub>ra</sub>	Recovered Charge, 50% chord	-	7200	-	I <sub>TM</sub> =2000A, t <sub>p</sub> =2000μs, di/dt=10A/μs, V <sub>r</sub> =100V	μC
I <sub>rm</sub>	Reverse recovery current	-	270	-		A
t <sub>rr</sub>	Reverse recovery time, 50% chord	-	53	-		μs
t <sub>q</sub>	Turn-off time	600	-	700	I <sub>TM</sub> =2000A, t <sub>p</sub> =2000μs, di/dt=10A/μs, V <sub>r</sub> =100V, V <sub>dr</sub> =80%V <sub>DRM</sub> , dV <sub>dr</sub> /dt=20V/μs (Note 2)	μs
		900	-	1300	I <sub>TM</sub> =2000A, t <sub>p</sub> =2000μs, di/dt=10A/μs, V <sub>r</sub> =100V, V <sub>dr</sub> =80%V <sub>DRM</sub> , dV <sub>dr</sub> /dt=200V/μs (Note 2)	
R <sub>thJK</sub>	Thermal resistance, junction to heatsink	-	-	0.005	Double side cooled	K/W
		-	-	0.012	Cathode side cooled	K/W
		-	-	0.009	Anode side cooled	K/W
F	Mounting force	76	-	93	(Note 3)	kN
W <sub>t</sub>	Weight	-	1.6	-		kg

Notes: -

- 1) Unless otherwise stated T<sub>J</sub>=125°C.
- 2) Standard test condition for t<sub>q</sub> dV<sub>dr</sub>/dt=200V/μs. For other dV<sub>dr</sub>/dt values please consult factory.
- 3) For other clamp forces please consult factory.

## Notes on Ratings and Characteristics

### 1.0 Voltage Grade Table

Voltage Grade	$V_{DRM}$ $V_{DSM}$ $V_{RRM}$ V	$V_{RSM}$ V	$V_D$ $V_R$ DC V
48	4800	4900	2880
52	5200	5300	3120

### 2.0 Extension of Voltage Grades

This report is applicable to other and higher voltage grades when supply has been agreed by Sales/Production.

### 3.0 De-rating Factor

A blocking voltage de-rating factor of 0.13%/°C is applicable to this device for  $T_j$  below 25°C.

### 4.0 Repetitive dv/dt

Standard dv/dt is 1000V/μs.

### 5.0 Gate Drive

The nominal requirement for a typical gate drive is illustrated below. An open circuit voltage of at least 30V is assumed. This gate drive must be applied when using the full di/dt capability of the device.

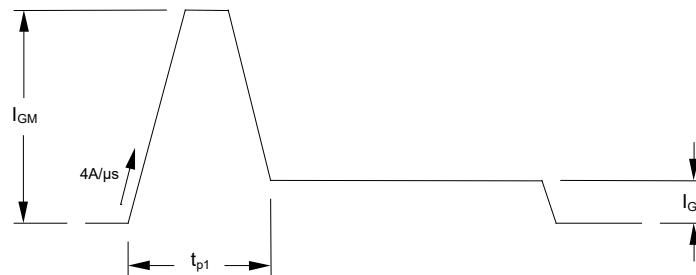

The magnitude of  $I_{GM}$  should be between five and ten times  $I_{GT}$ , which is shown on page 2. Its duration ( $t_{p1}$ ) should be 20μs or sufficient to allow the anode current to reach ten times  $I_L$ , whichever is greater. Otherwise, an increase in pulse current could be needed to supply the necessary charge to trigger. The 'back-porch' current  $I_G$  should remain flowing for the same duration as the anode current and have a magnitude in the order of 1.5 times  $I_{GT}$ .

### 6.0 Rate of rise of on-state current

The maximum un-primed rate of rise of on-state current must not exceed 200A/μs at any time during turn-on on a non-repetitive basis. For repetitive performance, the on-state rate of rise of current must not exceed 400A/μs at any time during turn-on. Note that these values of rate of rise of current apply to the total device current including that from any local snubber network.

## 7.0 Computer Modelling Parameters

### 7.1 Device Dissipation Calculations

$$I_{AV} = \frac{-V_0 + \sqrt{V_0^2 + 4 \cdot ff^2 \cdot r_s \cdot W_{AV}}}{2 \cdot ff^2 \cdot r_s} \quad \text{and:} \quad W_{AV} = \frac{\Delta T}{R_{th}}$$

$$\Delta T = T_{j\max} - T_{Hs}$$

Where  $V_0=1.168V$ ,  $r_s=0.209m\Omega$ ,

$R_{th}$  = Supplementary thermal impedance, see table below.

$ff$  = Form factor, see table below.

Supplementary Thermal Impedance							
Conduction Angle	30°	60°	90°	120°	180°	270°	d.c.
Square wave Double Side Cooled	0.00556	0.00549	0.00543	0.00538	0.00527	0.00514	0.00500
Square wave Cathode Side Cooled	0.01292	0.01285	0.01278	0.01271	0.01259	0.01244	0.01200
Sine wave Double Side Cooled	0.00551	0.00543	0.00537	0.00531	0.00515		
Sine wave Cathode Side Cooled	0.01286	0.01277	0.01270	0.01263	0.01245		

Form Factors							
Conduction Angle	30°	60°	90°	120°	180°	270°	d.c.
Square wave	3.46	2.45	2	1.73	1.41	1.15	1
Sine wave	3.98	2.78	2.22	1.88	1.57		

### 7.2 Calculating $V_T$ using ABCD Coefficients

The on-state characteristic  $I_T$  vs.  $V_T$ , on page 5 is represented in two ways;

- (i) the well established  $V_0$  and  $r_s$  tangent used for rating purposes and
- (ii) a set of constants A, B, C, D, forming the coefficients of the representative equation for  $V_T$  in terms of  $I_T$  given below:

$$V_T = A + B \cdot \ln(I_T) + C \cdot I_T + D \cdot \sqrt{I_T}$$

The constants, derived by curve fitting software, are given below for both hot and cold characteristics. The resulting values for  $V_T$  agree with the true device characteristic over a current range, which is limited to that plotted.

25°C Coefficients		125°C Coefficients	
A	1.683769	A	0.705645
B	-0.075056	B	0.033959
C	$1.265907 \times 10^{-4}$	C	$1.774236 \times 10^{-4}$
D	$4.878457 \times 10^{-3}$	D	$4.804952 \times 10^{-3}$

## 7.3 D.C. Thermal Impedance Calculation

$$r_t = \sum_{p=1}^{p=n} r_p \cdot \left( 1 - e^{-\frac{t}{\tau_p}} \right)$$

Where  $p = 1$  to  $n$ ,  $n$  is the number of terms in the series and:

- $t$  = Duration of heating pulse in seconds.
- $r_t$  = Thermal resistance at time  $t$ .
- $r_p$  = Amplitude of  $p^{\text{th}}$  term.
- $\tau_p$  = Time Constant of  $r_p$  term.

D.C. Double Side Cooled			
Term	1	2	3
$r_p$	$2.761048 \times 10^{-3}$	$1.738044 \times 10^{-3}$	$5.209655 \times 10^{-4}$
$\tau_p$	0.8332002	0.1416775	0.01436119

D.C. Cathode Side Cooled			
Term	1	2	3
$r_p$	$9.855141 \times 10^{-3}$	$1.983482 \times 10^{-3}$	$4.775474 \times 10^{-4}$
$\tau_p$	4.147275	0.1396446	0.0116827

**Curves**

Figure 1 - On-state characteristics of Limit device

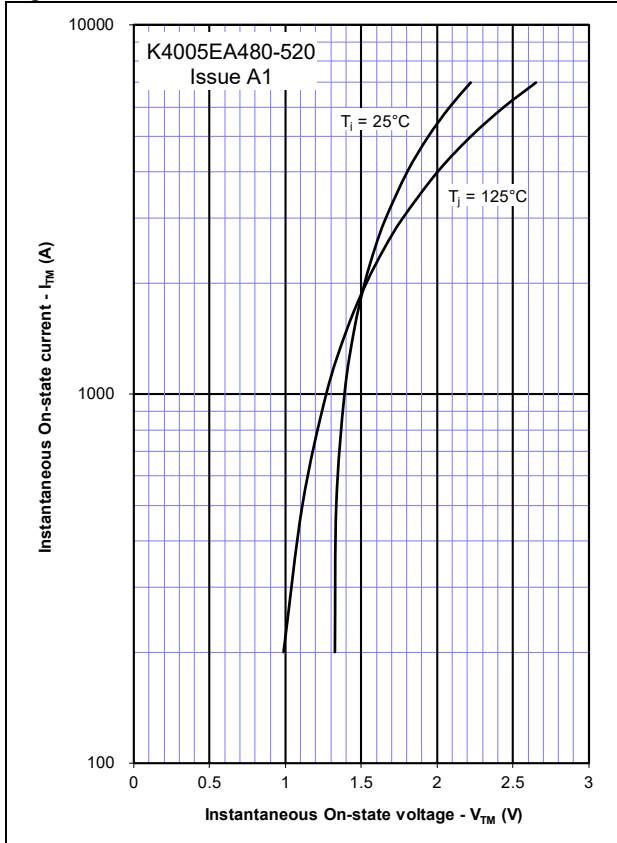

Figure 2 - Transient Thermal Impedance

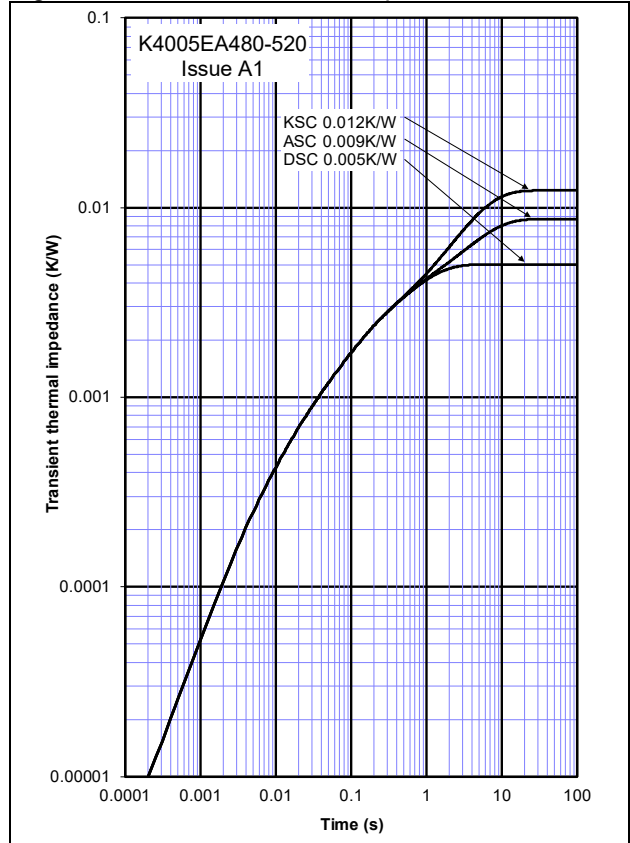

Figure 3 - Gate Characteristics - Trigger Limits

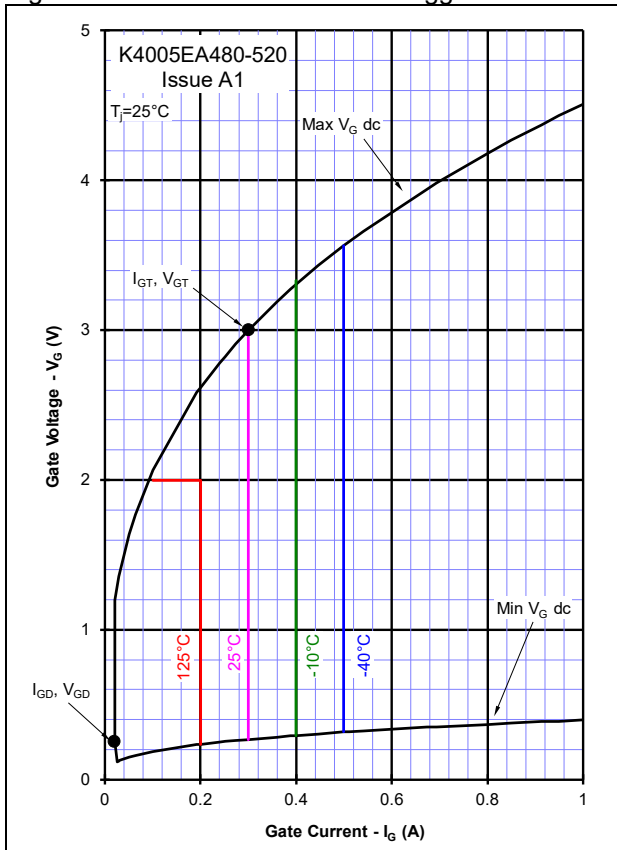

Figure 4 - Gate Characteristics - Power Curves

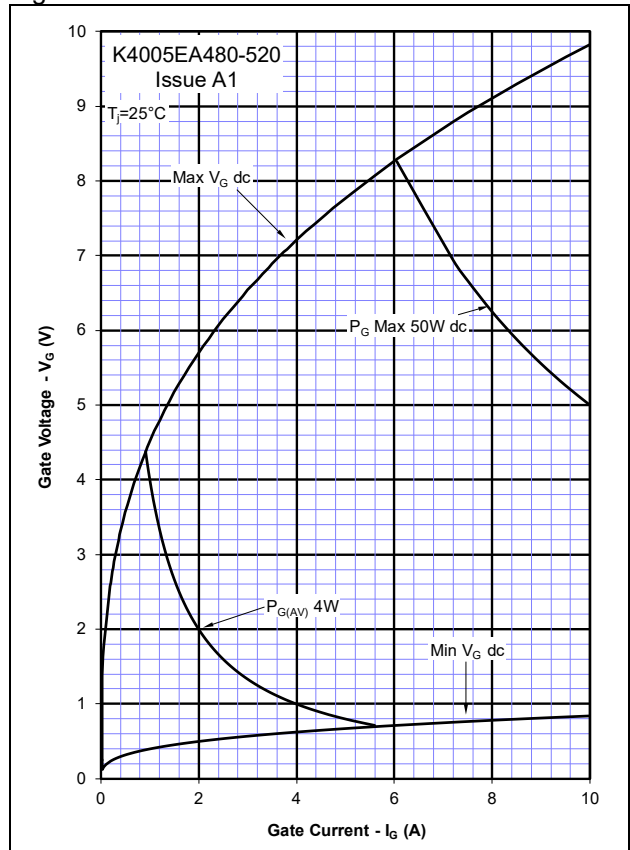

Figure 5 – Recovered Charge,  $Q_{rr}$

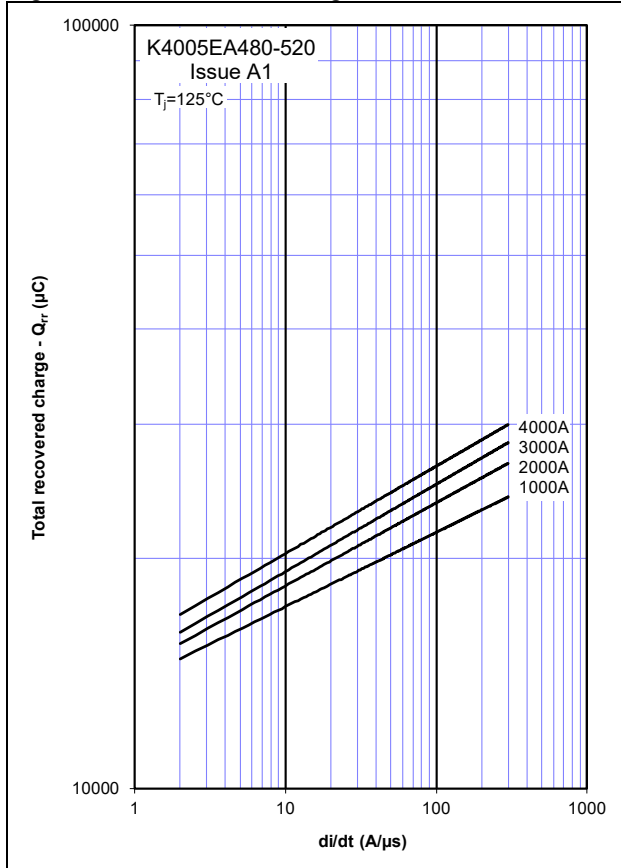

Figure 6 – Recovered charge,  $Q_{ra}$  (50% chord)

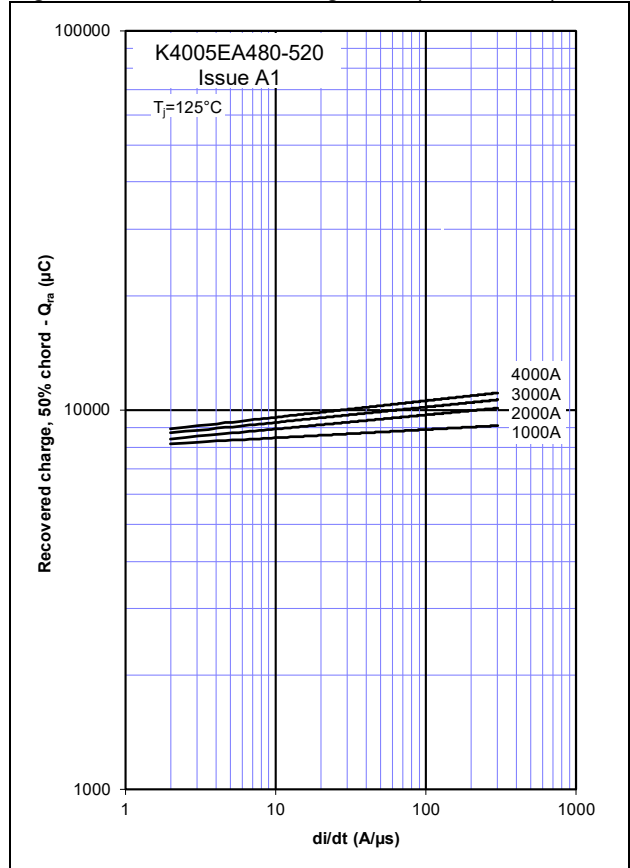

Figure 7 – Reverse recovery current,  $I_{rm}$

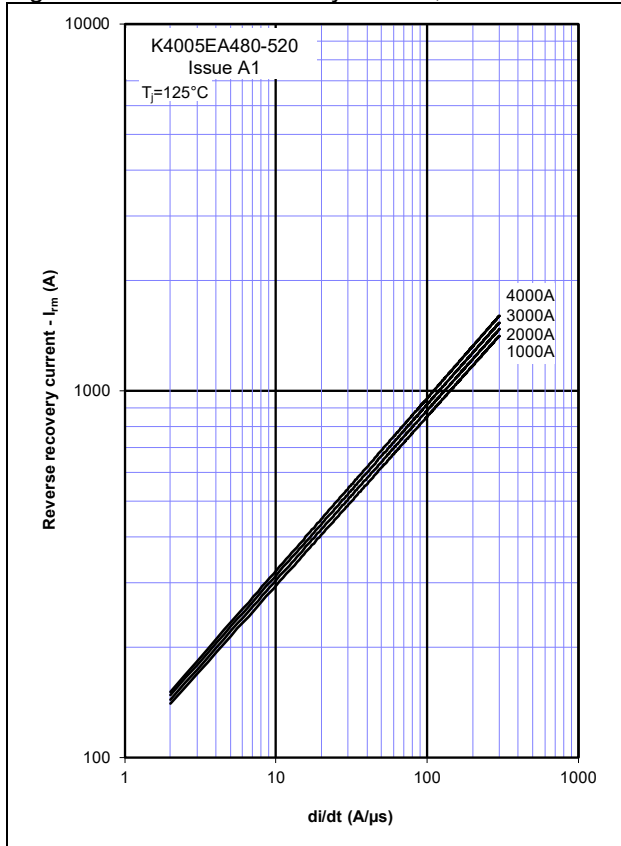

Figure 8 – Reverse recovery time,  $t_{rr}$

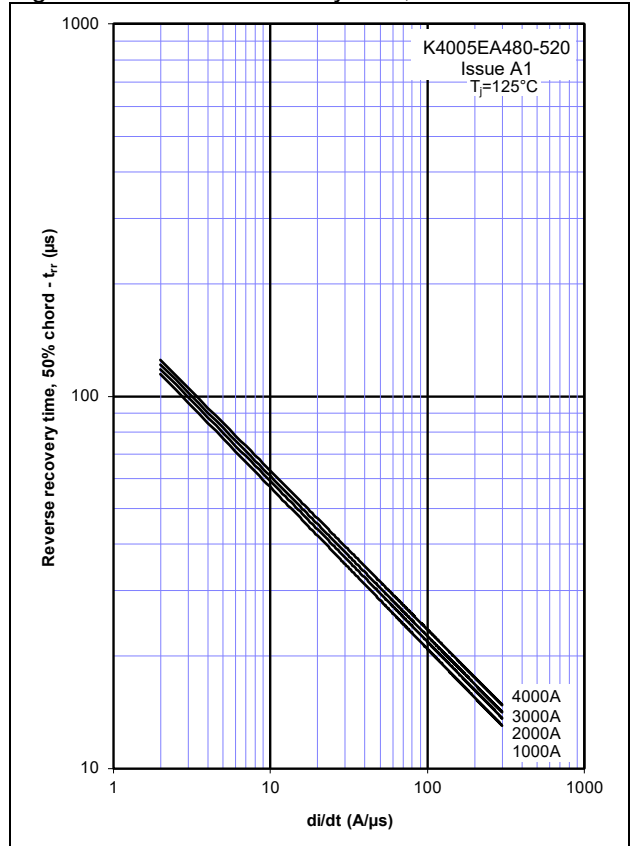

Figure 9 – On-state current vs. Power dissipation – Double Side Cooled (Sine wave)

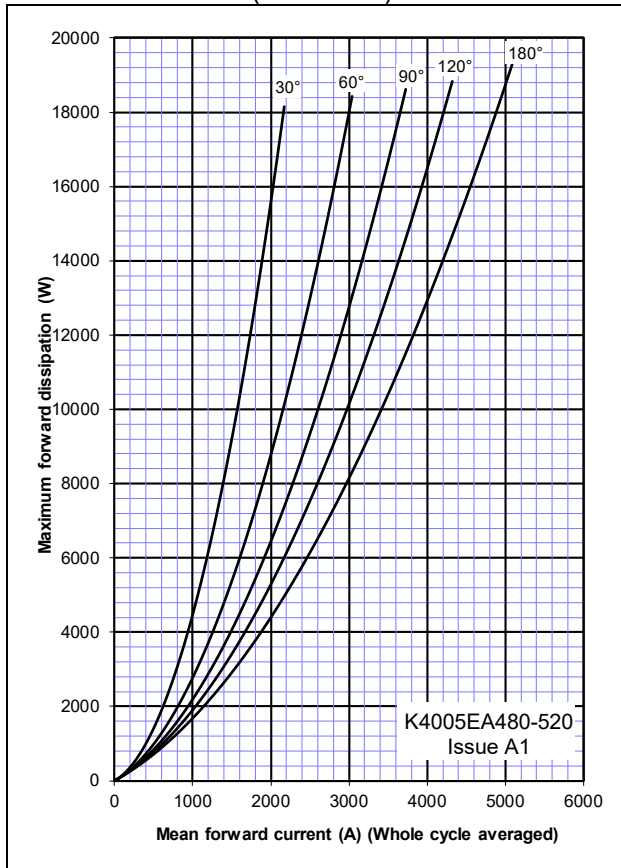

Figure 10 – On-state current vs. Heatsink temperature - Double Side Cooled (Sine wave)

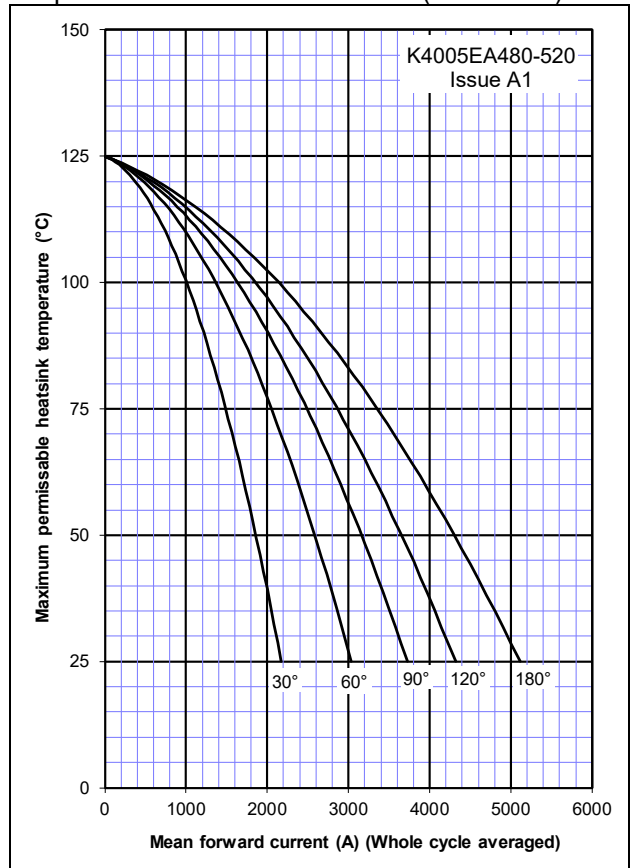

Figure 11 – On-state current vs. Power dissipation – Double Side Cooled (Square wave)

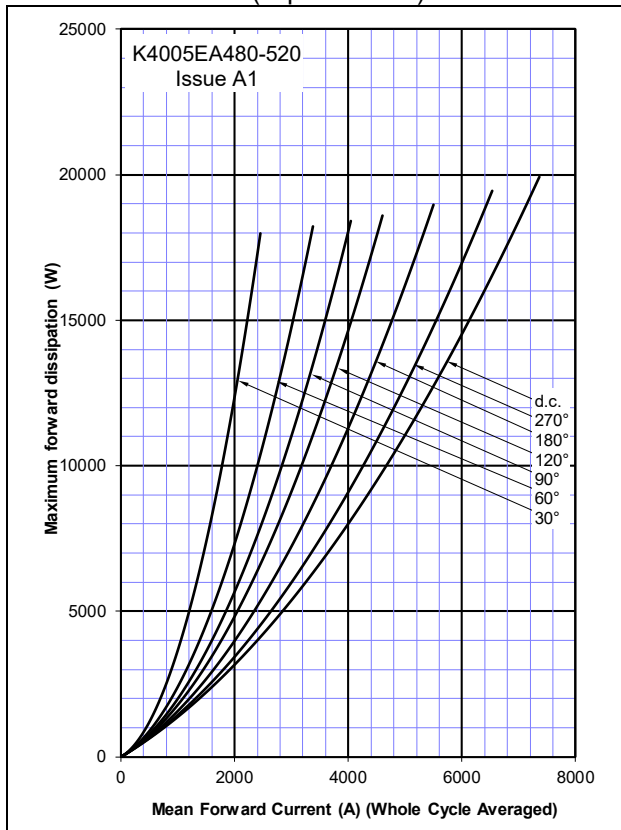

Figure 12 – On-state current vs. Heatsink temperature - Double Side Cooled (Square wave)

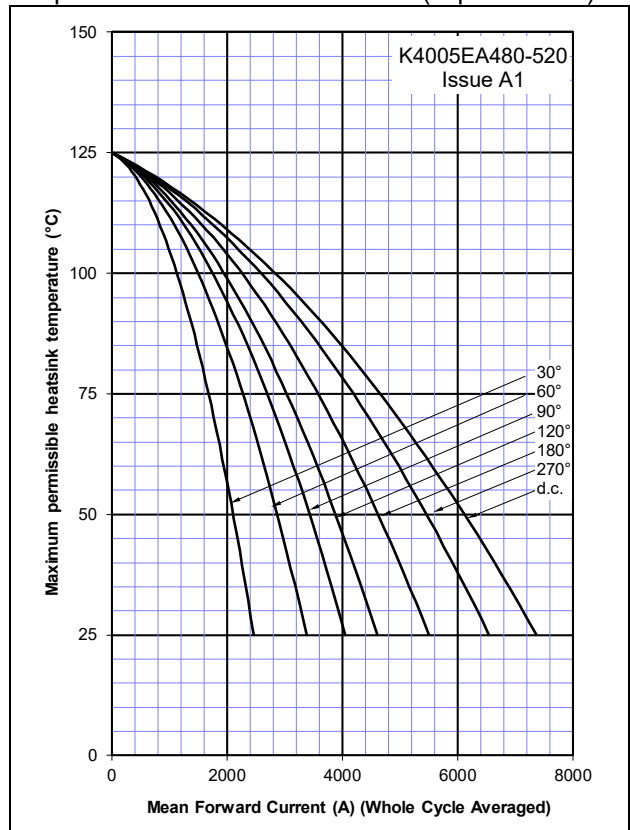



Figure 13 – On-state current vs. Power dissipation – Cathode Side Cooled (Sine wave)

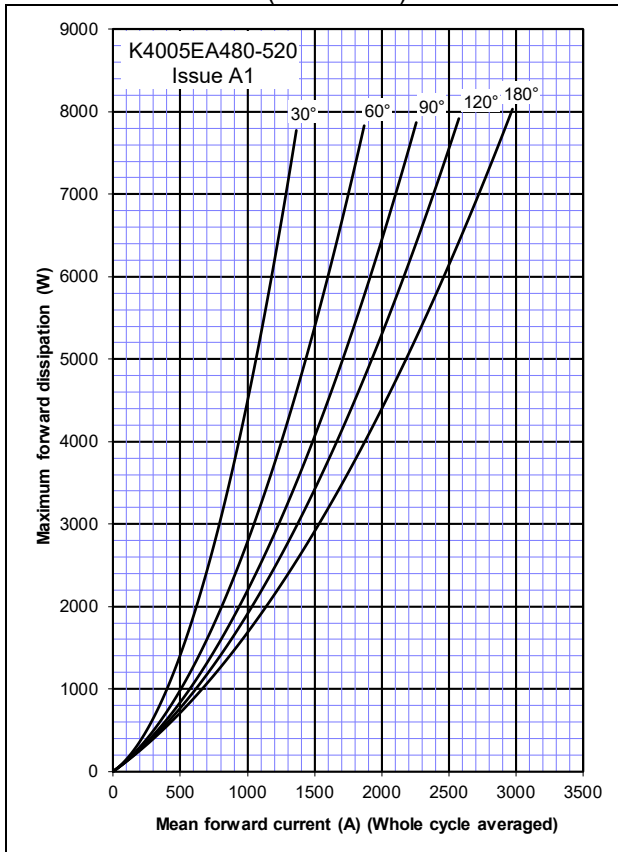

Figure 14 – On-state current vs. Heatsink temperature - Cathode Side Cooled (Sine wave)

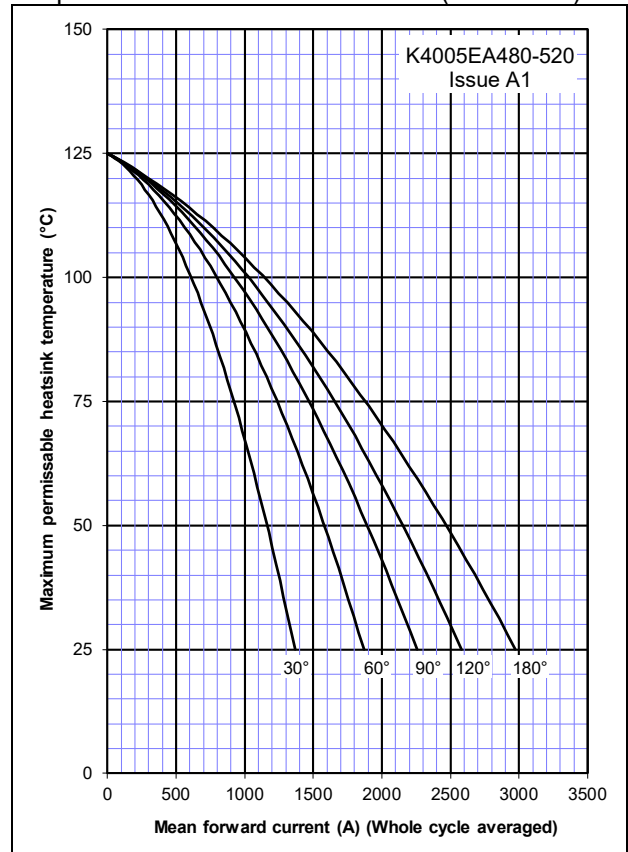

Figure 15 – On-state current vs. Power dissipation – Cathode Side Cooled (Square wave)

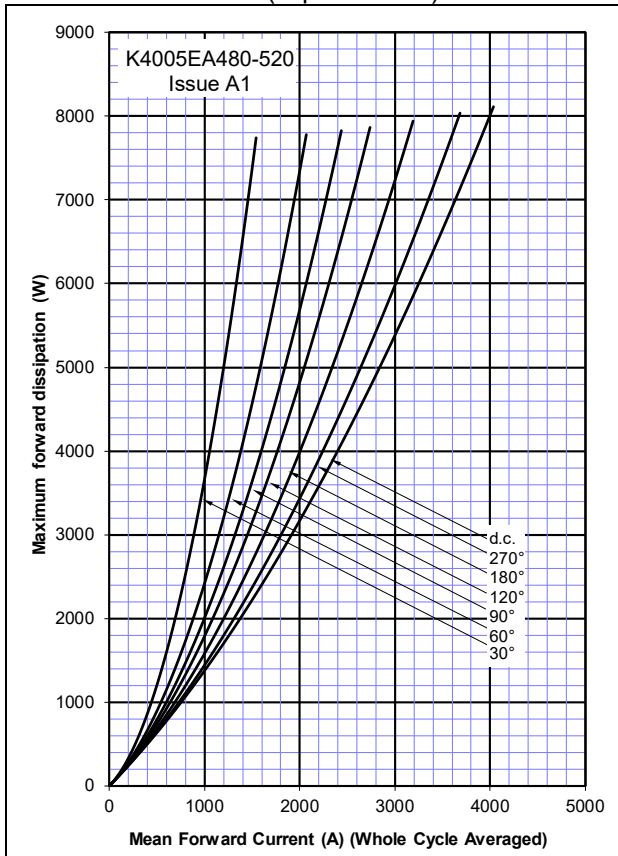

Figure 16 – On-state current vs. Heatsink temperature - Cathode Side Cooled (Square wave)

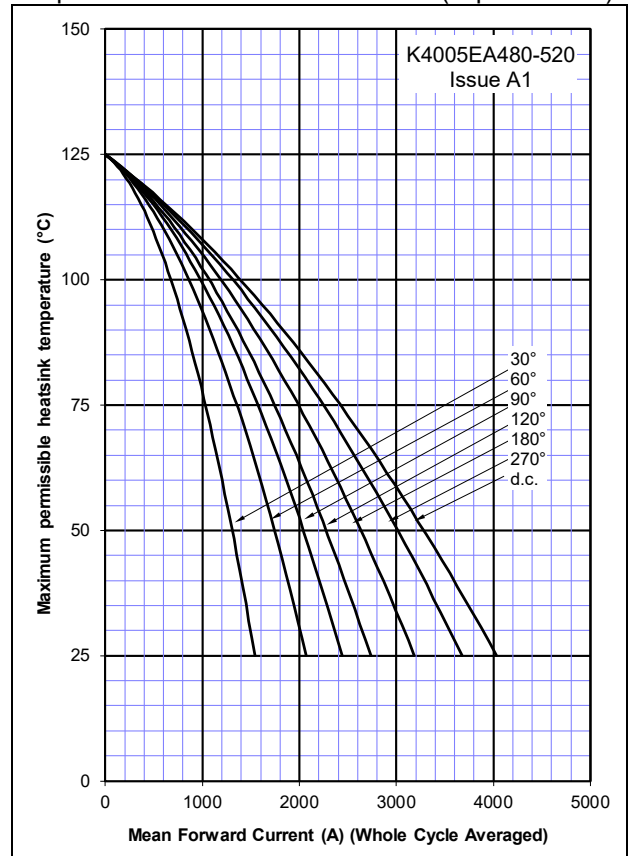
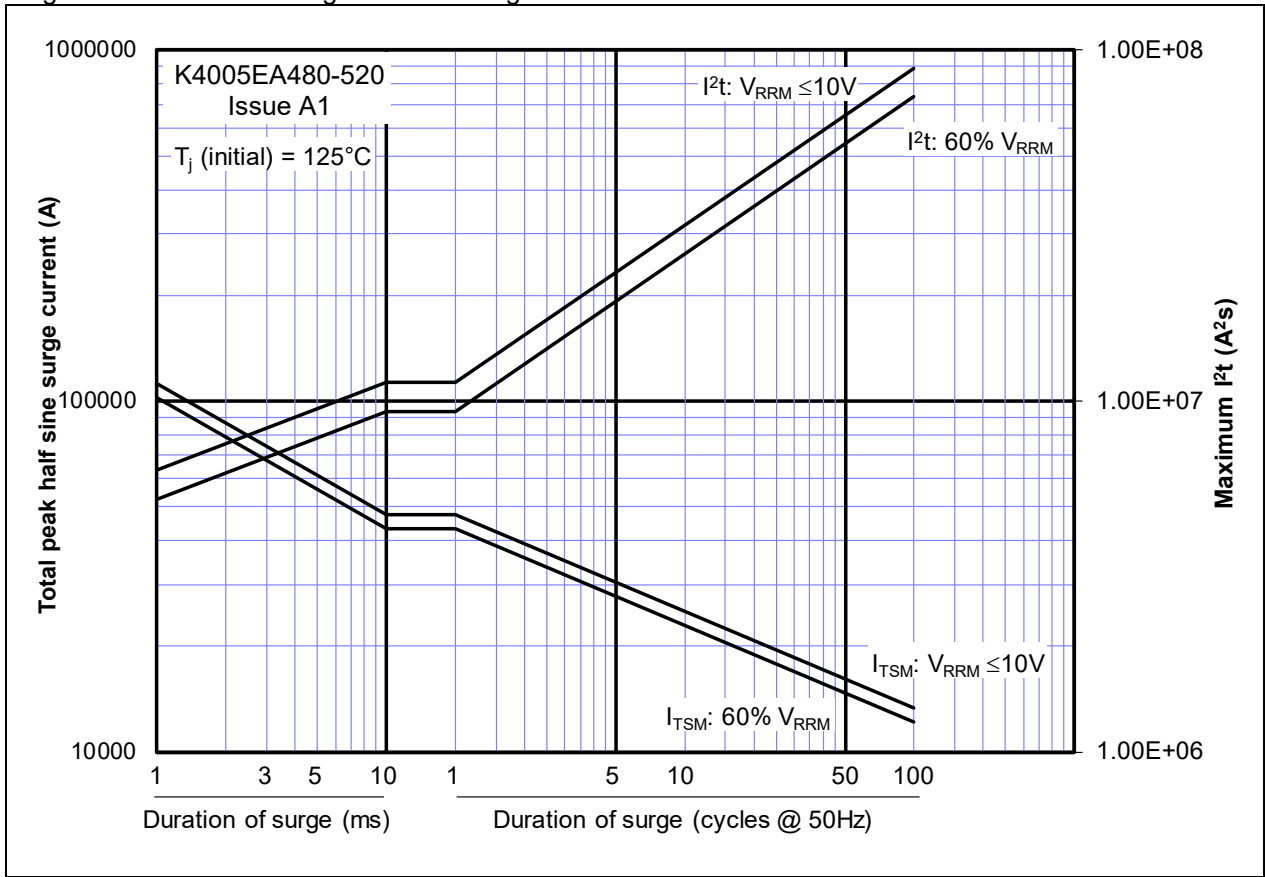
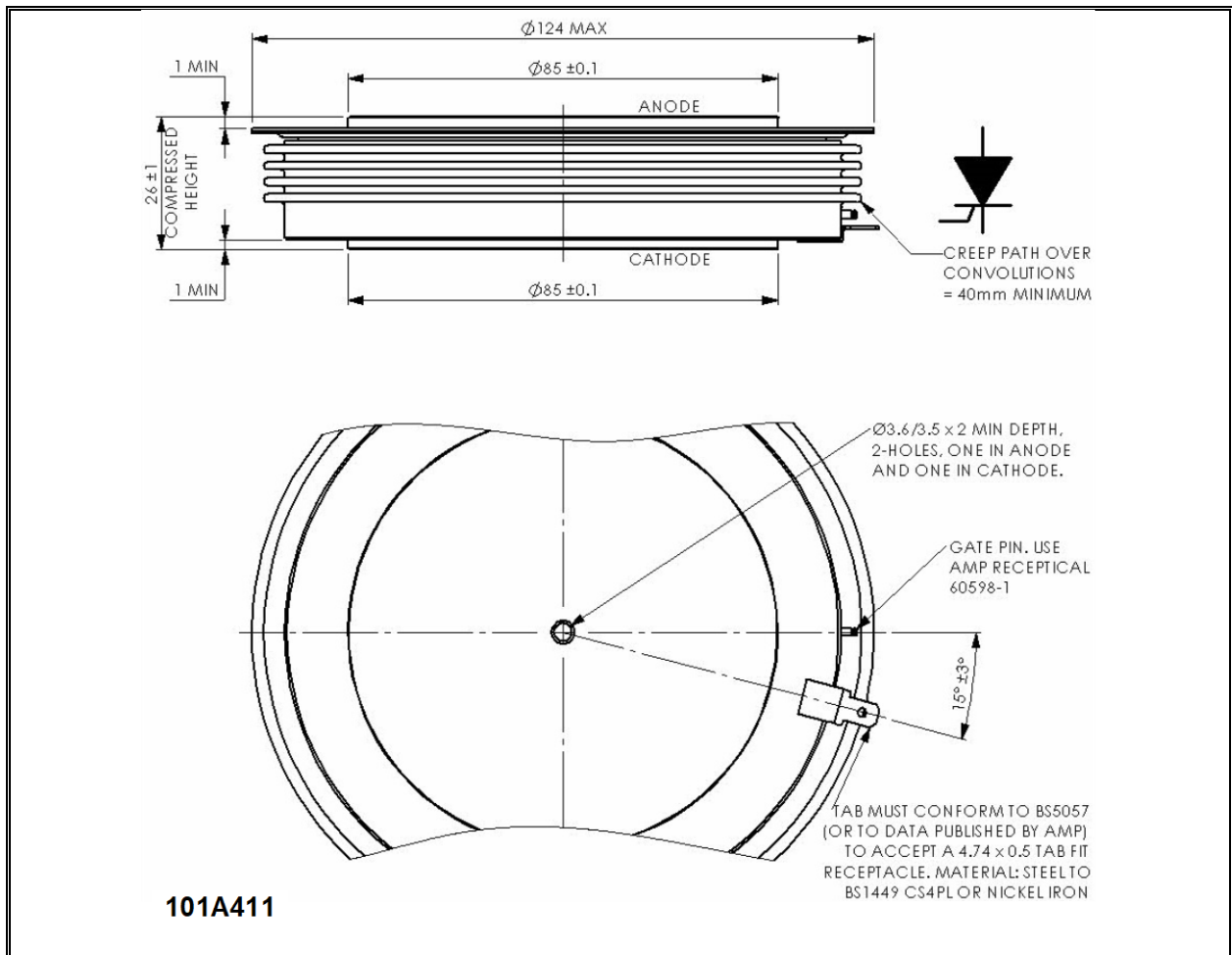

Figure 17 – Maximum surge and I<sup>2</sup>t Ratings



**Outline Drawing & Ordering Information**

**ORDERING INFORMATION**

(Please quote 10 digit code as below)

<b>K4005</b>	<b>EA</b>	<b>◆◆</b>	<b>0</b>
Fixed Type Code	Fixed Outline Code	Voltage Code 48 & 52	Fixed turn-off time code

 Typical order code: K4005EA480 – 4800V  $V_{DRM}$ ,  $V_{RRM}$ , 1000V/ $\mu$ s dv/dt, 26mm clamp height capsule.

**IXYS Long Beach Inc**  
 2500 Mira Mar Avenue  
 Long Beach CA 90815 USA  
 Tel: +1 (562) 296 6584  
 Fax: +1 (562) 296 6585  
 Email: [www.powerstacksus@littelfuse.com](mailto:www.powerstacksus@littelfuse.com)



**IXYS UK Westcode Ltd**  
 Langley Park Way, Langley Park,  
 Chippenham, Wiltshire, SN15 1GE.  
 Tel: +44 (0)1249 455500  
 Fax: +44 (0)1249 659448  
 E-mail: <https://www.littelfuse.com/contactus.aspx>

[www.littelfuse.com](http://www.littelfuse.com)
<https://www.littelfuse.com/products/power-semiconductors/high-power.aspx>

The information contained herein is confidential and is protected by Copyright. The information may not be used or disclosed except with the written permission of and in the manner permitted by the proprietors IXYS UK Westcode Ltd.

© IXYS UK Westcode Ltd.

In the interest of product improvement, IXYS UK Westcode reserves the right to change specifications at any time without prior notice.

Devices with a suffix code (2-letter, 3-letter or letter/digit/letter combination) added to their generic code are not necessarily subject to the conditions and limits contained in this report.



Disclaimer Notice - Information furnished is believed to be accurate and reliable. However, users should independently evaluate the suitability of and test each product selected for their own applications. Littelfuse products are not designed for, and may not be used in, all applications. Read complete Disclaimer Notice at [www.littelfuse.com/disclaimer-electronics](http://www.littelfuse.com/disclaimer-electronics).